

赤字：設備、運用又は体制の相違（設計方針の相違）
 青字：記載箇所又は記載内容の相違（記載方針の相違）
 緑字：記載表現、設備名称の相違（実質的な相違なし）

大阪発電所3/4号炉					女川原子力発電所2号炉					泊発電所3号炉					相違理由					
4号炉防護対象設備リスト（原子炉格納容器内設置設備除く）(9/9)					表1 防護対象設備一覧 (18/27)					表1 防護対象設備一覧 (18/35)					【大阪】 記載方針の相違 女川審査実績の反映 【女川・大阪】 記載方針の相違 設計方針の相違					
系統	設備	設置建屋	設置高さ		機能喪失高さ*	系統	設備	区画番号	設置建屋	E.L. [m]	機能 ^①	系統	設備	区画番号	設置建屋	基本設定高さ ^② [m]	個別測定高さ ^③ [m]	設定箇所	安全機能	【大阪】 記載方針の相違 設計方針の相違 ・泊では評価ガイドの要求に則り、機能喪失高さは、保守的に機能喪失すると仮定した高さである「評価高さ（基本設定箇所）」を標準としているが、評価高さで没水してしまう機器については「実力高さ（個別測定箇所）」を適用している。 上記を踏まえ、表1には防護対象設備の「基本設定箇所」と「個別測定箇所」の機能喪失高さを併記し、どちらを採用しているか明確となるよう設定箇所を記載している。（島根2号炉、柏崎6.7号炉と同様） ・設備名称等については、炉型の違い及びプラント設計の違いによる相違 【女川】 設計方針の相違 安全機能に関して、炉型の相違により機能名称が異なるが、「止める」「冷やす」「閉じ込める」「ピット冷却」の達成を目的とした機能であることに相違はない。
			E.L. + [m]	床面 [m]																
換気空調系	4A, 4Bほう酸ポンプ室温度調節計 (4TC-2601, 2611)	原子炉周辺建屋	10.0	10.70	0.70	原子炉格納容器内系	貯蔵用(1)(2)冷却水貯留槽(1)	9-01F-11	原子炉建屋	9.530	②③④⑤⑥⑦	原子炉格納容器	B-1格納容器スプレィ冷却器	3B5-E-2	原子炉建屋	1.12	1.44	基本	⑤	
換気空調系	4ほう酸タンク室温度(1), (2), (3), (4) (4TS-2602, 2603, 2612, 2613)	原子炉周辺建屋	10.0	11.30	1.30	原子炉格納容器内系	貯蔵用(1)(2)冷却水貯留槽(2)	9-01F-4	原子炉建屋	9.710	②③④⑤⑥⑦	原子炉格納容器	出口C/V外周隔離弁	3B5-E-2	原子炉建屋	1.12	1.44	基本	⑤	
換気空調系	4A, 4B中央制御室非常用循環ファン	制御建屋	29.3	29.93	0.63	原子炉格納容器内系	貯蔵用(1)(2)冷却水貯留槽(3)	9-01F-4	原子炉建屋	9.720	②③④⑤⑥⑦	原子炉格納容器	系	3B5-E-2	原子炉建屋	1.12	1.44	基本	⑤	
換気空調系	4A, 4B中央制御室非常用循環ファン現場操作箱 (4LB-97, 98)	制御建屋	29.3	30.50	1.20	原子炉格納容器内系	貯蔵用(1)(2)冷却水貯留槽(4)	9-01F-14	原子炉建屋	9.960	②③④⑤⑥⑦	原子炉格納容器	スプレィ	3B5-E-2	原子炉建屋	1.12	1.44	基本	⑤	
換気空調系	4A, 4B中央制御室非常用循環ファン入口ダンパ (4D-VS-602A, B)	制御建屋	29.3	29.65	0.35	原子炉格納容器内系	貯蔵用(1)(2)冷却水貯留槽(5)	9-01F-14	原子炉建屋	9.280	②③④⑤⑥⑦	原子炉格納容器	系	3B5-E-2	原子炉建屋	1.12	1.44	基本	⑤	
換気空調系	4A, 4B中央制御室外気取入流量調節ダンパ (4HCD-2874, 2875)	制御建屋	29.3	30.79	1.49	原子炉格納容器内系	貯蔵用(1)(2)冷却水貯留槽(6)	9-01F-14	原子炉建屋	9.130 ^⑧	②③④⑤⑥⑦	原子炉格納容器	スプレィ	3B5-E-2	原子炉建屋	1.12	1.44	個別	⑤	
換気空調系	4A, 4B中央制御室事故時外気取入流量調節ダンパ (4HCD-2889, 2890)	制御建屋	29.3	29.68	0.38	原子炉格納容器内系	貯蔵用(1)(2)冷却水貯留槽(7)	9-01F-14	原子炉建屋	9.130 ^⑧	②③④⑤⑥⑦	原子炉格納容器	系	3B5-E-2	原子炉建屋	1.12	1.44	個別	⑤	
換気空調系	4A, 4B中央制御室事故時循環流量調節ダンパ (4HCD-2891, 2892)	制御建屋	29.3	31.28	1.98	原子炉格納容器内系	貯蔵用(1)(2)冷却水貯留槽(8)	9-01F-14	原子炉建屋	9.700	②③④⑤⑥⑦	原子炉格納容器	系	3B5-E-2	原子炉建屋	1.12	1.44	個別	⑤	
換気空調系	4A, 4B中央制御室非常用循環ファン出口流量 (4FS-2904, 2905)	制御建屋	26.1	27.42	1.32	原子炉格納容器内系	貯蔵用(1)(2)冷却水貯留槽(9)	9-01F-14	原子炉建屋	9.370	②③④⑤⑥⑦	原子炉格納容器	系	3B5-E-2	原子炉建屋	1.12	1.44	基本	⑤⑥	
換気空調系	4A, 4B中央制御室外気取入調節ダンパ流量設定 (4HC-2874, 2875)	制御建屋	29.3	30.91	1.61	原子炉格納容器内系	貯蔵用(1)(2)冷却水貯留槽(10)	9-01F-14	原子炉建屋	1.040	②③④⑤⑥⑦	原子炉格納容器	系	3B5-E-2	原子炉建屋	1.12	1.44	基本	⑤⑥	
換気空調系	4A, 4B中央制御室事故時外気取入調節ダンパ流量設定 (4HC-2889, 2890)	制御建屋	29.3	30.51	1.21	原子炉格納容器内系	貯蔵用(1)(2)冷却水貯留槽(11)	9-01F-14	原子炉建屋	9.190	②③④⑤⑥⑦	原子炉格納容器	系	3B5-E-2	原子炉建屋	1.12	1.44	基本	⑤⑥	
換気空調系	4A, 4B中央制御室事故時循環ダンパ流量設定 (4HC-2891, 2892)	制御建屋	29.3	31.31	2.01	原子炉格納容器内系	貯蔵用(1)(2)冷却水貯留槽(12)	9-01F-14	原子炉建屋	1.040	②③④⑤⑥⑦	原子炉格納容器	系	3B5-E-2	原子炉建屋	1.12	1.44	基本	⑤⑥	
換気空調系	4A, 4Bアニュラス空気浄化ファン (4VSE3A, B)	原子炉周辺建屋	20.9	21.46	0.56	原子炉格納容器内系	貯蔵用(1)(2)冷却水貯留槽(13)	9-01F-14	原子炉建屋	9.710	②③④⑤⑥⑦	原子炉格納容器	系	3B5-E-2	原子炉建屋	1.12	1.44	基本	⑤⑥	
換気空調系	4A, 4Bアニュラス空気浄化ファン現場操作箱 (4LB-52, 53)	原子炉周辺建屋	20.9	22.10	1.20	原子炉格納容器内系	貯蔵用(1)(2)冷却水貯留槽(14)	9-01F-14	原子炉建屋	9.710	②③④⑤⑥⑦	原子炉格納容器	系	3B5-E-2	原子炉建屋	1.12	1.44	基本	⑤⑥	
換気空調系	4A, 4Bアニュラス排気ダンパ (4D-VS-101A, B)	原子炉周辺建屋	20.9	21.35	0.45	高圧中心スプレィ格納容器内系	高圧中心スプレィ格納容器内系	9-01F-11	原子炉建屋	9.070	③④⑤⑥	高圧中心スプレィ格納容器	系	3B5-F-2	原子炉建屋	0.85	1.15	基本	⑤⑦	
換気空調系	4A, 4Bアニュラス戻りダンパ (4D-VS-104A, B)	原子炉周辺建屋	17.1	19.21	2.11	高圧中心スプレィ格納容器内系	高圧中心スプレィ格納容器内系	9-01F-11	原子炉建屋	9.070	③④⑤⑥	高圧中心スプレィ格納容器	系	3B5-F-2	原子炉建屋	0.85	1.15	基本	⑤⑦	
換気空調系	4A, 4Bアニュラス全量排気弁 (4V-VS-102A, B)	原子炉周辺建屋	20.9	22.98	2.08	高圧中心スプレィ格納容器内系	高圧中心スプレィ格納容器内系	9-01F-11	原子炉建屋	9.450	③④⑤⑥	高圧中心スプレィ格納容器	系	3B5-F-2	原子炉建屋	0.85	1.12	基本	⑤⑦	
換気空調系	4A, 4Bアニュラス少量排気弁 (4V-VS-103A, B)	原子炉周辺建屋	20.9	23.27	2.37	高圧中心スプレィ格納容器内系	高圧中心スプレィ格納容器内系	9-01F-11	原子炉建屋	9.450	③④⑤⑥	高圧中心スプレィ格納容器	系	3B5-F-2	原子炉建屋	0.85	1.12	基本	⑤⑦	

赤字：設備、運用又は体制の相違（設計方針の相違）
 青字：記載箇所又は記載内容の相違（記載方針の相違）
 緑字：記載表現、設備名称の相違（実質的な相違なし）

大阪発電所3/4号炉	女川原子力発電所2号炉	泊発電所3号炉	相違理由																																																																																																																																																																																																																																				
	<p style="text-align: center;">表1 防護対象設備一覧 (19/27)</p> <table border="1" style="width: 100%; border-collapse: collapse;"> <thead> <tr> <th>系統</th> <th>設備</th> <th>区画番号</th> <th>設置建屋</th> <th>E.L.^{※1}(m)</th> <th>機能^{※2}</th> </tr> </thead> <tbody> <tr> <td>高圧炉心スプレイ補給系統</td> <td>高圧炉心スプレイポンプ駆動水取上げレーンシステム (74C-13000)</td> <td>8-12-2</td> <td>原子炉建屋 原子炉層</td> <td>6.070</td> <td>②③④⑤</td> </tr> <tr> <td>高圧炉心スプレイ補給系統</td> <td>高圧炉心スプレイポンプ駆動水取上げ設備 (74C-13000)</td> <td>8-12-2</td> <td>原子炉建屋 原子炉層</td> <td>6.110[※]</td> <td>②③④⑤</td> </tr> <tr> <td>高圧炉心スプレイ補給系統</td> <td>高圧炉心スプレイポンプ駆動水取上げポンプ (74C-13001)</td> <td>8-12-4</td> <td>原子炉建屋</td> <td>6.060</td> <td>②③④⑤</td> </tr> <tr> <td>高圧炉心スプレイ補給系統</td> <td>高圧炉心スプレイポンプ駆動水取上げポンプ (74C-13002)</td> <td>8-12-4</td> <td>原子炉建屋</td> <td>6.360</td> <td>②③④⑤</td> </tr> <tr> <td>使用済燃料ピット</td> <td>使用済燃料ピット水取上げポンプ(1) (321-7301A)</td> <td>8-12-6</td> <td>原子炉建屋 行風機</td> <td>6.000</td> <td>②③④⑤⑥⑦⑧⑨⑩</td> </tr> <tr> <td>使用済燃料ピット</td> <td>使用済燃料ピット水取上げポンプ(2) (321-7301C)</td> <td>8-12-6</td> <td>原子炉建屋 行風機</td> <td>6.000</td> <td>②③④⑤⑥⑦⑧⑨⑩</td> </tr> <tr> <td>使用済燃料ピット</td> <td>使用済燃料ピット水取上げポンプ(3) (321-7301A)</td> <td>8-12-6</td> <td>原子炉建屋 行風機</td> <td>6.110</td> <td>②③④⑤⑥⑦⑧⑨⑩</td> </tr> <tr> <td>使用済燃料ピット</td> <td>使用済燃料ピット水取上げポンプ(4) (321-7301C)</td> <td>8-12-6</td> <td>原子炉建屋 行風機</td> <td>6.110</td> <td>②③④⑤⑥⑦⑧⑨⑩</td> </tr> <tr> <td>使用済燃料ピット</td> <td>使用済燃料ピット水取上げポンプ(5) (321-7301A)</td> <td>8-12-6</td> <td>原子炉建屋 行風機</td> <td>6.220</td> <td>②③④⑤⑥⑦⑧⑨⑩</td> </tr> <tr> <td>使用済燃料ピット</td> <td>使用済燃料ピット水取上げポンプ(6) (321-7301C)</td> <td>8-12-6</td> <td>原子炉建屋 行風機</td> <td>6.220</td> <td>②③④⑤⑥⑦⑧⑨⑩</td> </tr> <tr> <td>使用済燃料ピット</td> <td>使用済燃料ピット水取上げポンプ(7) (321-7301A)</td> <td>8-12-6</td> <td>原子炉建屋 行風機</td> <td>6.200</td> <td>②③④⑤⑥⑦⑧⑨⑩</td> </tr> <tr> <td>使用済燃料ピット</td> <td>使用済燃料ピット水取上げポンプ(8) (321-7301C)</td> <td>8-12-6</td> <td>原子炉建屋 行風機</td> <td>6.200</td> <td>②③④⑤⑥⑦⑧⑨⑩</td> </tr> <tr> <td>使用済燃料ピット</td> <td>高圧炉心スプレイポンプ駆動水取上げポンプ(1) (721-4701A)</td> <td>8-12-6</td> <td>原子炉建屋 行風機</td> <td>6.560</td> <td>②③④⑤⑥⑦⑧⑨⑩</td> </tr> <tr> <td>使用済燃料ピット</td> <td>高圧炉心スプレイポンプ駆動水取上げポンプ(2) (721-4701B)</td> <td>8-12-6</td> <td>原子炉建屋 行風機</td> <td>6.360</td> <td>②③④⑤⑥⑦⑧⑨⑩</td> </tr> <tr> <td>使用済燃料ピット</td> <td>高圧炉心スプレイポンプ駆動水取上げポンプ(3) (721-4701C)</td> <td>8-12-6</td> <td>原子炉建屋 行風機</td> <td>6.840</td> <td>②③④⑤⑥⑦⑧⑨⑩</td> </tr> <tr> <td>使用済燃料ピット</td> <td>高圧炉心スプレイポンプ駆動水取上げポンプ(4) (721-4701D)</td> <td>8-12-6</td> <td>原子炉建屋 行風機</td> <td>6.840</td> <td>②③④⑤⑥⑦⑧⑨⑩</td> </tr> <tr> <td>使用済燃料ピット</td> <td>高圧炉心スプレイポンプ駆動水取上げポンプ(5) (721-4701E)</td> <td>8-12-6</td> <td>原子炉建屋 行風機</td> <td>1.175</td> <td>②③④⑤⑥⑦⑧⑨⑩</td> </tr> <tr> <td>使用済燃料ピット</td> <td>使用済燃料ピット水取上げポンプ(1) (321-7301B)</td> <td>8-12-6</td> <td>原子炉建屋 行風機</td> <td>6.000</td> <td>②③④⑤⑥⑦⑧⑨⑩</td> </tr> <tr> <td>使用済燃料ピット</td> <td>使用済燃料ピット水取上げポンプ(2) (321-7301D)</td> <td>8-12-6</td> <td>原子炉建屋 行風機</td> <td>6.000</td> <td>②③④⑤⑥⑦⑧⑨⑩</td> </tr> <tr> <td>使用済燃料ピット</td> <td>使用済燃料ピット水取上げポンプ(3) (321-7301B)</td> <td>8-12-6</td> <td>原子炉建屋 行風機</td> <td>6.110</td> <td>②③④⑤⑥⑦⑧⑨⑩</td> </tr> <tr> <td>使用済燃料ピット</td> <td>使用済燃料ピット水取上げポンプ(4) (321-7301D)</td> <td>8-12-6</td> <td>原子炉建屋 行風機</td> <td>6.110</td> <td>②③④⑤⑥⑦⑧⑨⑩</td> </tr> <tr> <td>使用済燃料ピット</td> <td>使用済燃料ピット水取上げポンプ(5) (321-7301B)</td> <td>8-12-6</td> <td>原子炉建屋 行風機</td> <td>6.220</td> <td>②③④⑤⑥⑦⑧⑨⑩</td> </tr> <tr> <td>使用済燃料ピット</td> <td>使用済燃料ピット水取上げポンプ(6) (321-7301D)</td> <td>8-12-6</td> <td>原子炉建屋 行風機</td> <td>6.220</td> <td>②③④⑤⑥⑦⑧⑨⑩</td> </tr> <tr> <td>使用済燃料ピット</td> <td>高圧炉心スプレイポンプ駆動水取上げポンプ(1) (721-4701A)</td> <td>8-12-6</td> <td>原子炉建屋 行風機</td> <td>6.560</td> <td>②③④⑤⑥⑦⑧⑨⑩</td> </tr> <tr> <td>使用済燃料ピット</td> <td>高圧炉心スプレイポンプ駆動水取上げポンプ(2) (721-4701B)</td> <td>8-12-6</td> <td>原子炉建屋 行風機</td> <td>6.420</td> <td>②③④⑤⑥⑦⑧⑨⑩</td> </tr> </tbody> </table> <p>※1：注水より機能喪失する床面からの高さ（E.L.またはE.L.相当高さ） ※2：①緊急停止機能 ②緊急停止機能 ③緊急停止機能 ④緊急停止機能 ⑤緊急停止機能 ⑥緊急停止機能 ⑦緊急停止機能 ⑧緊急停止機能 ⑨緊急停止機能 ⑩緊急停止機能 ⑪緊急停止機能 ⑫緊急停止機能 ⑬緊急停止機能 ⑭緊急停止機能 ⑮緊急停止機能 ⑯緊急停止機能 ⑰緊急停止機能 ⑱緊急停止機能 ⑲緊急停止機能 ⑳緊急停止機能 ㉑緊急停止機能 ㉒緊急停止機能 ㉓緊急停止機能 ㉔緊急停止機能 ㉕緊急停止機能 ㉖緊急停止機能 ㉗緊急停止機能 ㉘緊急停止機能 ㉙緊急停止機能 ㉚緊急停止機能 ㉛緊急停止機能 ㉜緊急停止機能 ㉝緊急停止機能 ㉞緊急停止機能 ㉟緊急停止機能 ㊱緊急停止機能 ㊲緊急停止機能 ㊳緊急停止機能 ㊴緊急停止機能 ㊵緊急停止機能 ㊶緊急停止機能 ㊷緊急停止機能 ㊸緊急停止機能 ㊹緊急停止機能 ㊺緊急停止機能 ㊻緊急停止機能 ㊼緊急停止機能 ㊽緊急停止機能 ㊾緊急停止機能 ㊿緊急停止機能</p>	系統	設備	区画番号	設置建屋	E.L. ^{※1} (m)	機能 ^{※2}	高圧炉心スプレイ補給系統	高圧炉心スプレイポンプ駆動水取上げレーンシステム (74C-13000)	8-12-2	原子炉建屋 原子炉層	6.070	②③④⑤	高圧炉心スプレイ補給系統	高圧炉心スプレイポンプ駆動水取上げ設備 (74C-13000)	8-12-2	原子炉建屋 原子炉層	6.110 [※]	②③④⑤	高圧炉心スプレイ補給系統	高圧炉心スプレイポンプ駆動水取上げポンプ (74C-13001)	8-12-4	原子炉建屋	6.060	②③④⑤	高圧炉心スプレイ補給系統	高圧炉心スプレイポンプ駆動水取上げポンプ (74C-13002)	8-12-4	原子炉建屋	6.360	②③④⑤	使用済燃料ピット	使用済燃料ピット水取上げポンプ(1) (321-7301A)	8-12-6	原子炉建屋 行風機	6.000	②③④⑤⑥⑦⑧⑨⑩	使用済燃料ピット	使用済燃料ピット水取上げポンプ(2) (321-7301C)	8-12-6	原子炉建屋 行風機	6.000	②③④⑤⑥⑦⑧⑨⑩	使用済燃料ピット	使用済燃料ピット水取上げポンプ(3) (321-7301A)	8-12-6	原子炉建屋 行風機	6.110	②③④⑤⑥⑦⑧⑨⑩	使用済燃料ピット	使用済燃料ピット水取上げポンプ(4) (321-7301C)	8-12-6	原子炉建屋 行風機	6.110	②③④⑤⑥⑦⑧⑨⑩	使用済燃料ピット	使用済燃料ピット水取上げポンプ(5) (321-7301A)	8-12-6	原子炉建屋 行風機	6.220	②③④⑤⑥⑦⑧⑨⑩	使用済燃料ピット	使用済燃料ピット水取上げポンプ(6) (321-7301C)	8-12-6	原子炉建屋 行風機	6.220	②③④⑤⑥⑦⑧⑨⑩	使用済燃料ピット	使用済燃料ピット水取上げポンプ(7) (321-7301A)	8-12-6	原子炉建屋 行風機	6.200	②③④⑤⑥⑦⑧⑨⑩	使用済燃料ピット	使用済燃料ピット水取上げポンプ(8) (321-7301C)	8-12-6	原子炉建屋 行風機	6.200	②③④⑤⑥⑦⑧⑨⑩	使用済燃料ピット	高圧炉心スプレイポンプ駆動水取上げポンプ(1) (721-4701A)	8-12-6	原子炉建屋 行風機	6.560	②③④⑤⑥⑦⑧⑨⑩	使用済燃料ピット	高圧炉心スプレイポンプ駆動水取上げポンプ(2) (721-4701B)	8-12-6	原子炉建屋 行風機	6.360	②③④⑤⑥⑦⑧⑨⑩	使用済燃料ピット	高圧炉心スプレイポンプ駆動水取上げポンプ(3) (721-4701C)	8-12-6	原子炉建屋 行風機	6.840	②③④⑤⑥⑦⑧⑨⑩	使用済燃料ピット	高圧炉心スプレイポンプ駆動水取上げポンプ(4) (721-4701D)	8-12-6	原子炉建屋 行風機	6.840	②③④⑤⑥⑦⑧⑨⑩	使用済燃料ピット	高圧炉心スプレイポンプ駆動水取上げポンプ(5) (721-4701E)	8-12-6	原子炉建屋 行風機	1.175	②③④⑤⑥⑦⑧⑨⑩	使用済燃料ピット	使用済燃料ピット水取上げポンプ(1) (321-7301B)	8-12-6	原子炉建屋 行風機	6.000	②③④⑤⑥⑦⑧⑨⑩	使用済燃料ピット	使用済燃料ピット水取上げポンプ(2) (321-7301D)	8-12-6	原子炉建屋 行風機	6.000	②③④⑤⑥⑦⑧⑨⑩	使用済燃料ピット	使用済燃料ピット水取上げポンプ(3) (321-7301B)	8-12-6	原子炉建屋 行風機	6.110	②③④⑤⑥⑦⑧⑨⑩	使用済燃料ピット	使用済燃料ピット水取上げポンプ(4) (321-7301D)	8-12-6	原子炉建屋 行風機	6.110	②③④⑤⑥⑦⑧⑨⑩	使用済燃料ピット	使用済燃料ピット水取上げポンプ(5) (321-7301B)	8-12-6	原子炉建屋 行風機	6.220	②③④⑤⑥⑦⑧⑨⑩	使用済燃料ピット	使用済燃料ピット水取上げポンプ(6) (321-7301D)	8-12-6	原子炉建屋 行風機	6.220	②③④⑤⑥⑦⑧⑨⑩	使用済燃料ピット	高圧炉心スプレイポンプ駆動水取上げポンプ(1) (721-4701A)	8-12-6	原子炉建屋 行風機	6.560	②③④⑤⑥⑦⑧⑨⑩	使用済燃料ピット	高圧炉心スプレイポンプ駆動水取上げポンプ(2) (721-4701B)	8-12-6	原子炉建屋 行風機	6.420	②③④⑤⑥⑦⑧⑨⑩	<p style="text-align: center;">表1 防護対象設備一覧 (19/35)</p> <table border="1" style="width: 100%; border-collapse: collapse;"> <thead> <tr> <th>系統</th> <th>設備</th> <th>区画番号</th> <th>設置建屋</th> <th>基本設定高さ^{※1}(a)</th> <th>個別測定高さ^{※2}(a)</th> <th>設定箇所</th> <th>安全機能</th> </tr> </thead> <tbody> <tr> <td>原子炉格納容器スプレイ系</td> <td>格納容器圧力 (IV) (3PT-390)</td> <td>3B-B-2</td> <td>原子炉建屋</td> <td>0.85</td> <td>1.12</td> <td>基本</td> <td>②③</td> </tr> <tr> <td>使用済燃料ピット水浄化球系</td> <td>A-使用済燃料ピットポンプ (3SFP1A)</td> <td>3B-B-7</td> <td>原子炉建屋</td> <td>0.69</td> <td>0.75</td> <td>基本</td> <td>⑥</td> </tr> <tr> <td>使用済燃料ピット水浄化球系</td> <td>B-使用済燃料ピットポンプ (3SFP1B)</td> <td>3B-B-7</td> <td>原子炉建屋</td> <td>0.69</td> <td>0.76</td> <td>基本</td> <td>⑥</td> </tr> <tr> <td>高圧注入系</td> <td>A-高圧注入ポンプ (3SIP1A)</td> <td>3AB-L-9 (3AB-L-9)</td> <td>原子炉補助建屋</td> <td>0.33</td> <td>0.32</td> <td>個別</td> <td>②④</td> </tr> <tr> <td>高圧注入系</td> <td>B-高圧注入ポンプ (3SIP1B)</td> <td>3AB-L-2 (3AB-L-3)</td> <td>原子炉補助建屋</td> <td>0.33</td> <td>0.32</td> <td>個別</td> <td>②④</td> </tr> <tr> <td>高圧注入系</td> <td>A-高圧注入ポンプ燃料取替用水ピット側入口弁 (3V-SI-002A)</td> <td>3AB-B-9</td> <td>原子炉補助建屋</td> <td>0.80</td> <td>1.84</td> <td>個別</td> <td>②④⑤</td> </tr> <tr> <td>高圧注入系</td> <td>B-高圧注入ポンプ燃料取替用水ピット側入口弁 (3V-SI-002B)</td> <td>3AB-B-2</td> <td>原子炉補助建屋</td> <td>0.80</td> <td>1.84</td> <td>個別</td> <td>②④⑤</td> </tr> <tr> <td>高圧注入系</td> <td>A-高圧注入ポンプ第1ミニロー弁 (3V-SI-014A)</td> <td>3AB-B-22</td> <td>原子炉補助建屋</td> <td>0.72</td> <td>0.72</td> <td>基本</td> <td>②④</td> </tr> </tbody> </table> <p>※1：保守的に機能喪失すると仮定した床面からの高さ ※2：設水により機能喪失する床面からの高さ ①安全上特に重要な関連機能 ②緊急停止機能 ③緊急停止機能 ④緊急停止機能 ⑤緊急停止機能 ⑥緊急停止機能 ⑦緊急停止機能 ⑧緊急停止機能 ⑨緊急停止機能 ⑩緊急停止機能 ⑪緊急停止機能 ⑫緊急停止機能 ⑬緊急停止機能 ⑭緊急停止機能 ⑮緊急停止機能 ⑯緊急停止機能 ⑰緊急停止機能 ⑱緊急停止機能 ⑲緊急停止機能 ⑳緊急停止機能 ㉑緊急停止機能 ㉒緊急停止機能 ㉓緊急停止機能 ㉔緊急停止機能 ㉕緊急停止機能 ㉖緊急停止機能 ㉗緊急停止機能 ㉘緊急停止機能 ㉙緊急停止機能 ㉚緊急停止機能 ㉛緊急停止機能 ㉜緊急停止機能 ㉝緊急停止機能 ㉞緊急停止機能 ㉟緊急停止機能 ㊱緊急停止機能 ㊲緊急停止機能 ㊳緊急停止機能 ㊴緊急停止機能 ㊵緊急停止機能 ㊶緊急停止機能 ㊷緊急停止機能 ㊸緊急停止機能 ㊹緊急停止機能 ㊺緊急停止機能 ㊻緊急停止機能 ㊼緊急停止機能 ㊽緊急停止機能 ㊾緊急停止機能 ㊿緊急停止機能</p>	系統	設備	区画番号	設置建屋	基本設定高さ ^{※1} (a)	個別測定高さ ^{※2} (a)	設定箇所	安全機能	原子炉格納容器スプレイ系	格納容器圧力 (IV) (3PT-390)	3B-B-2	原子炉建屋	0.85	1.12	基本	②③	使用済燃料ピット水浄化球系	A-使用済燃料ピットポンプ (3SFP1A)	3B-B-7	原子炉建屋	0.69	0.75	基本	⑥	使用済燃料ピット水浄化球系	B-使用済燃料ピットポンプ (3SFP1B)	3B-B-7	原子炉建屋	0.69	0.76	基本	⑥	高圧注入系	A-高圧注入ポンプ (3SIP1A)	3AB-L-9 (3AB-L-9)	原子炉補助建屋	0.33	0.32	個別	②④	高圧注入系	B-高圧注入ポンプ (3SIP1B)	3AB-L-2 (3AB-L-3)	原子炉補助建屋	0.33	0.32	個別	②④	高圧注入系	A-高圧注入ポンプ燃料取替用水ピット側入口弁 (3V-SI-002A)	3AB-B-9	原子炉補助建屋	0.80	1.84	個別	②④⑤	高圧注入系	B-高圧注入ポンプ燃料取替用水ピット側入口弁 (3V-SI-002B)	3AB-B-2	原子炉補助建屋	0.80	1.84	個別	②④⑤	高圧注入系	A-高圧注入ポンプ第1ミニロー弁 (3V-SI-014A)	3AB-B-22	原子炉補助建屋	0.72	0.72	基本	②④	<p>【女川】 <u>記載方針の相違</u> <u>設計方針の相違</u></p> <p>・泊では評価ガイドの要求に則り、機能喪失高さは、保守的に機能喪失すると仮定した高さである「評価高さ（基本設定箇所）」を標準としているが、評価高さで設水してしまう機器については「実力高さ（個別測定箇所）」を適用している。</p> <p>上記を踏まえ、表1には防護対象設備の「基本設定箇所」と「個別測定箇所」の機能喪失高さを併記し、どちらを採用しているか明確となるよう設定箇所を記載している。（島根2号炉、柏崎6,7号炉と同様）</p> <p>・設備名称等については、炉型の違い及びプラント設計の違いによる相違</p> <p>・安全機能に関して、炉型の相違により機能名称が異なるが、「止める」「冷やす」「閉じ込める」「ピット冷却」の達成を目的とした機能であることに相違はない。</p>
系統	設備	区画番号	設置建屋	E.L. ^{※1} (m)	機能 ^{※2}																																																																																																																																																																																																																																		
高圧炉心スプレイ補給系統	高圧炉心スプレイポンプ駆動水取上げレーンシステム (74C-13000)	8-12-2	原子炉建屋 原子炉層	6.070	②③④⑤																																																																																																																																																																																																																																		
高圧炉心スプレイ補給系統	高圧炉心スプレイポンプ駆動水取上げ設備 (74C-13000)	8-12-2	原子炉建屋 原子炉層	6.110 [※]	②③④⑤																																																																																																																																																																																																																																		
高圧炉心スプレイ補給系統	高圧炉心スプレイポンプ駆動水取上げポンプ (74C-13001)	8-12-4	原子炉建屋	6.060	②③④⑤																																																																																																																																																																																																																																		
高圧炉心スプレイ補給系統	高圧炉心スプレイポンプ駆動水取上げポンプ (74C-13002)	8-12-4	原子炉建屋	6.360	②③④⑤																																																																																																																																																																																																																																		
使用済燃料ピット	使用済燃料ピット水取上げポンプ(1) (321-7301A)	8-12-6	原子炉建屋 行風機	6.000	②③④⑤⑥⑦⑧⑨⑩																																																																																																																																																																																																																																		
使用済燃料ピット	使用済燃料ピット水取上げポンプ(2) (321-7301C)	8-12-6	原子炉建屋 行風機	6.000	②③④⑤⑥⑦⑧⑨⑩																																																																																																																																																																																																																																		
使用済燃料ピット	使用済燃料ピット水取上げポンプ(3) (321-7301A)	8-12-6	原子炉建屋 行風機	6.110	②③④⑤⑥⑦⑧⑨⑩																																																																																																																																																																																																																																		
使用済燃料ピット	使用済燃料ピット水取上げポンプ(4) (321-7301C)	8-12-6	原子炉建屋 行風機	6.110	②③④⑤⑥⑦⑧⑨⑩																																																																																																																																																																																																																																		
使用済燃料ピット	使用済燃料ピット水取上げポンプ(5) (321-7301A)	8-12-6	原子炉建屋 行風機	6.220	②③④⑤⑥⑦⑧⑨⑩																																																																																																																																																																																																																																		
使用済燃料ピット	使用済燃料ピット水取上げポンプ(6) (321-7301C)	8-12-6	原子炉建屋 行風機	6.220	②③④⑤⑥⑦⑧⑨⑩																																																																																																																																																																																																																																		
使用済燃料ピット	使用済燃料ピット水取上げポンプ(7) (321-7301A)	8-12-6	原子炉建屋 行風機	6.200	②③④⑤⑥⑦⑧⑨⑩																																																																																																																																																																																																																																		
使用済燃料ピット	使用済燃料ピット水取上げポンプ(8) (321-7301C)	8-12-6	原子炉建屋 行風機	6.200	②③④⑤⑥⑦⑧⑨⑩																																																																																																																																																																																																																																		
使用済燃料ピット	高圧炉心スプレイポンプ駆動水取上げポンプ(1) (721-4701A)	8-12-6	原子炉建屋 行風機	6.560	②③④⑤⑥⑦⑧⑨⑩																																																																																																																																																																																																																																		
使用済燃料ピット	高圧炉心スプレイポンプ駆動水取上げポンプ(2) (721-4701B)	8-12-6	原子炉建屋 行風機	6.360	②③④⑤⑥⑦⑧⑨⑩																																																																																																																																																																																																																																		
使用済燃料ピット	高圧炉心スプレイポンプ駆動水取上げポンプ(3) (721-4701C)	8-12-6	原子炉建屋 行風機	6.840	②③④⑤⑥⑦⑧⑨⑩																																																																																																																																																																																																																																		
使用済燃料ピット	高圧炉心スプレイポンプ駆動水取上げポンプ(4) (721-4701D)	8-12-6	原子炉建屋 行風機	6.840	②③④⑤⑥⑦⑧⑨⑩																																																																																																																																																																																																																																		
使用済燃料ピット	高圧炉心スプレイポンプ駆動水取上げポンプ(5) (721-4701E)	8-12-6	原子炉建屋 行風機	1.175	②③④⑤⑥⑦⑧⑨⑩																																																																																																																																																																																																																																		
使用済燃料ピット	使用済燃料ピット水取上げポンプ(1) (321-7301B)	8-12-6	原子炉建屋 行風機	6.000	②③④⑤⑥⑦⑧⑨⑩																																																																																																																																																																																																																																		
使用済燃料ピット	使用済燃料ピット水取上げポンプ(2) (321-7301D)	8-12-6	原子炉建屋 行風機	6.000	②③④⑤⑥⑦⑧⑨⑩																																																																																																																																																																																																																																		
使用済燃料ピット	使用済燃料ピット水取上げポンプ(3) (321-7301B)	8-12-6	原子炉建屋 行風機	6.110	②③④⑤⑥⑦⑧⑨⑩																																																																																																																																																																																																																																		
使用済燃料ピット	使用済燃料ピット水取上げポンプ(4) (321-7301D)	8-12-6	原子炉建屋 行風機	6.110	②③④⑤⑥⑦⑧⑨⑩																																																																																																																																																																																																																																		
使用済燃料ピット	使用済燃料ピット水取上げポンプ(5) (321-7301B)	8-12-6	原子炉建屋 行風機	6.220	②③④⑤⑥⑦⑧⑨⑩																																																																																																																																																																																																																																		
使用済燃料ピット	使用済燃料ピット水取上げポンプ(6) (321-7301D)	8-12-6	原子炉建屋 行風機	6.220	②③④⑤⑥⑦⑧⑨⑩																																																																																																																																																																																																																																		
使用済燃料ピット	高圧炉心スプレイポンプ駆動水取上げポンプ(1) (721-4701A)	8-12-6	原子炉建屋 行風機	6.560	②③④⑤⑥⑦⑧⑨⑩																																																																																																																																																																																																																																		
使用済燃料ピット	高圧炉心スプレイポンプ駆動水取上げポンプ(2) (721-4701B)	8-12-6	原子炉建屋 行風機	6.420	②③④⑤⑥⑦⑧⑨⑩																																																																																																																																																																																																																																		
系統	設備	区画番号	設置建屋	基本設定高さ ^{※1} (a)	個別測定高さ ^{※2} (a)	設定箇所	安全機能																																																																																																																																																																																																																																
原子炉格納容器スプレイ系	格納容器圧力 (IV) (3PT-390)	3B-B-2	原子炉建屋	0.85	1.12	基本	②③																																																																																																																																																																																																																																
使用済燃料ピット水浄化球系	A-使用済燃料ピットポンプ (3SFP1A)	3B-B-7	原子炉建屋	0.69	0.75	基本	⑥																																																																																																																																																																																																																																
使用済燃料ピット水浄化球系	B-使用済燃料ピットポンプ (3SFP1B)	3B-B-7	原子炉建屋	0.69	0.76	基本	⑥																																																																																																																																																																																																																																
高圧注入系	A-高圧注入ポンプ (3SIP1A)	3AB-L-9 (3AB-L-9)	原子炉補助建屋	0.33	0.32	個別	②④																																																																																																																																																																																																																																
高圧注入系	B-高圧注入ポンプ (3SIP1B)	3AB-L-2 (3AB-L-3)	原子炉補助建屋	0.33	0.32	個別	②④																																																																																																																																																																																																																																
高圧注入系	A-高圧注入ポンプ燃料取替用水ピット側入口弁 (3V-SI-002A)	3AB-B-9	原子炉補助建屋	0.80	1.84	個別	②④⑤																																																																																																																																																																																																																																
高圧注入系	B-高圧注入ポンプ燃料取替用水ピット側入口弁 (3V-SI-002B)	3AB-B-2	原子炉補助建屋	0.80	1.84	個別	②④⑤																																																																																																																																																																																																																																
高圧注入系	A-高圧注入ポンプ第1ミニロー弁 (3V-SI-014A)	3AB-B-22	原子炉補助建屋	0.72	0.72	基本	②④																																																																																																																																																																																																																																

赤字：設備、運用又は体制の相違（設計方針の相違）
 青字：記載箇所又は記載内容の相違（記載方針の相違）
 緑字：記載表現、設備名称の相違（実質的な相違なし）

大阪発電所3/4号炉	女川原子力発電所2号炉	泊発電所3号炉	相違理由																																																																																																																																																																																																																																																																																																																
	<p style="text-align: center;">表1 防護対象設備一覧 (20/27)</p> <table border="1" style="width: 100%; border-collapse: collapse;"> <thead> <tr> <th>系統</th> <th>設備</th> <th>区画番号</th> <th>設置層</th> <th>E.L.^{※1}(m)</th> <th>機能^{※2}</th> </tr> </thead> <tbody> <tr> <td>機軸空調機用非常用冷却水</td> <td>機軸空調機用非常用冷却水(1)</td> <td>B-02-4</td> <td>原子炉建屋 付属層</td> <td>0.600</td> <td>②③④⑤⑥⑦⑧⑨⑩⑪⑫⑬⑭⑮⑯⑰⑱⑲⑳㉑㉒㉓㉔㉕㉖㉗㉘㉙㉚㉛㉜㉝㉞㉟㊱㊲㊳㊴㊵㊶㊷㊸㊹㊺㊻㊼㊽㊾㊿</td> </tr> <tr> <td>機軸空調機用非常用冷却水</td> <td>機軸空調機用非常用冷却水(2)</td> <td>B-02-4</td> <td>原子炉建屋 付属層</td> <td>0.600</td> <td>②③④⑤⑥⑦⑧⑨⑩⑪⑫⑬⑭⑮⑯⑰⑱⑲⑳㉑㉒㉓㉔㉕㉖㉗㉘㉙㉚㉛㉜㉝㉞㉟㊱㊲㊳㊴㊵㊶㊷㊸㊹㊺㊻㊼㊽㊾㊿</td> </tr> <tr> <td>機軸空調機用非常用冷却水</td> <td>機軸空調機用非常用冷却水(3)</td> <td>B-02-4</td> <td>原子炉建屋 付属層</td> <td>1.175</td> <td>②③④⑤⑥⑦⑧⑨⑩⑪⑫⑬⑭⑮⑯⑰⑱⑲⑳㉑㉒㉓㉔㉕㉖㉗㉘㉙㉚㉛㉜㉝㉞㉟㊱㊲㊳㊴㊵㊶㊷㊸㊹㊺㊻㊼㊽㊾㊿</td> </tr> <tr> <td>中央制御室制御盤</td> <td>中央制御室制御盤(1)</td> <td>C-02-1</td> <td>制御層</td> <td>0.000</td> <td>②③④⑤⑥⑦⑧⑨⑩⑪⑫⑬⑭⑮⑯⑰⑱⑲⑳㉑㉒㉓㉔㉕㉖㉗㉘㉙㉚㉛㉜㉝㉞㉟㊱㊲㊳㊴㊵㊶㊷㊸㊹㊺㊻㊼㊽㊾㊿</td> </tr> <tr> <td>中央制御室端子盤</td> <td>中央制御室端子盤(1)</td> <td>C-02-1</td> <td>制御層</td> <td>0.200</td> <td>②③④⑤⑥⑦⑧⑨⑩⑪⑫⑬⑭⑮⑯⑰⑱⑲⑳㉑㉒㉓㉔㉕㉖㉗㉘㉙㉚㉛㉜㉝㉞㉟㊱㊲㊳㊴㊵㊶㊷㊸㊹㊺㊻㊼㊽㊾㊿</td> </tr> <tr> <td>中央制御室端子盤</td> <td>中央制御室端子盤(2)</td> <td>C-02-2</td> <td>制御層</td> <td>0.200</td> <td>②③④⑤⑥⑦⑧⑨⑩⑪⑫⑬⑭⑮⑯⑰⑱⑲⑳㉑㉒㉓㉔㉕㉖㉗㉘㉙㉚㉛㉜㉝㉞㉟㊱㊲㊳㊴㊵㊶㊷㊸㊹㊺㊻㊼㊽㊾㊿</td> </tr> <tr> <td>中央制御室端子盤</td> <td>中央制御室端子盤(3)</td> <td>C-02-4</td> <td>制御層</td> <td>0.200</td> <td>②③④⑤⑥⑦⑧⑨⑩⑪⑫⑬⑭⑮⑯⑰⑱⑲⑳㉑㉒㉓㉔㉕㉖㉗㉘㉙㉚㉛㉜㉝㉞㉟㊱㊲㊳㊴㊵㊶㊷㊸㊹㊺㊻㊼㊽㊾㊿</td> </tr> <tr> <td>中央制御室端子盤</td> <td>中央制御室端子盤(4)</td> <td>C-02-4</td> <td>制御層</td> <td>0.200</td> <td>②③④⑤⑥⑦⑧⑨⑩⑪⑫⑬⑭⑮⑯⑰⑱⑲⑳㉑㉒㉓㉔㉕㉖㉗㉘㉙㉚㉛㉜㉝㉞㉟㊱㊲㊳㊴㊵㊶㊷㊸㊹㊺㊻㊼㊽㊾㊿</td> </tr> <tr> <td>中央制御室端子盤</td> <td>中央制御室端子盤(5)</td> <td>C-02-4</td> <td>制御層</td> <td>0.000</td> <td>②③④⑤⑥⑦⑧⑨⑩⑪⑫⑬⑭⑮⑯⑰⑱⑲⑳㉑㉒㉓㉔㉕㉖㉗㉘㉙㉚㉛㉜㉝㉞㉟㊱㊲㊳㊴㊵㊶㊷㊸㊹㊺㊻㊼㊽㊾㊿</td> </tr> <tr> <td>中央制御室端子盤</td> <td>中央制御室端子盤(6)</td> <td>C-02-4</td> <td>制御層</td> <td>0.000</td> <td>②③④⑤⑥⑦⑧⑨⑩⑪⑫⑬⑭⑮⑯⑰⑱⑲⑳㉑㉒㉓㉔㉕㉖㉗㉘㉙㉚㉛㉜㉝㉞㉟㊱㊲㊳㊴㊵㊶㊷㊸㊹㊺㊻㊼㊽㊾㊿</td> </tr> <tr> <td>中央制御室端子盤</td> <td>中央制御室端子盤(7)</td> <td>C-02-4</td> <td>制御層</td> <td>0.000</td> <td>②③④⑤⑥⑦⑧⑨⑩⑪⑫⑬⑭⑮⑯⑰⑱⑲⑳㉑㉒㉓㉔㉕㉖㉗㉘㉙㉚㉛㉜㉝㉞㉟㊱㊲㊳㊴㊵㊶㊷㊸㊹㊺㊻㊼㊽㊾㊿</td> </tr> <tr> <td>中央制御室端子盤</td> <td>中央制御室端子盤(8)</td> <td>C-02-4</td> <td>制御層</td> <td>0.000</td> <td>②③④⑤⑥⑦⑧⑨⑩⑪⑫⑬⑭⑮⑯⑰⑱⑲⑳㉑㉒㉓㉔㉕㉖㉗㉘㉙㉚㉛㉜㉝㉞㉟㊱㊲㊳㊴㊵㊶㊷㊸㊹㊺㊻㊼㊽㊾㊿</td> </tr> <tr> <td>中央制御室端子盤</td> <td>中央制御室端子盤(9)</td> <td>C-02-4</td> <td>制御層</td> <td>0.000</td> <td>②③④⑤⑥⑦⑧⑨⑩⑪⑫⑬⑭⑮⑯⑰⑱⑲⑳㉑㉒㉓㉔㉕㉖㉗㉘㉙㉚㉛㉜㉝㉞㉟㊱㊲㊳㊴㊵㊶㊷㊸㊹㊺㊻㊼㊽㊾㊿</td> </tr> <tr> <td>中央制御室端子盤</td> <td>中央制御室端子盤(10)</td> <td>C-02-4</td> <td>制御層</td> <td>0.000</td> <td>②③④⑤⑥⑦⑧⑨⑩⑪⑫⑬⑭⑮⑯⑰⑱⑲⑳㉑㉒㉓㉔㉕㉖㉗㉘㉙㉚㉛㉜㉝㉞㉟㊱㊲㊳㊴㊵㊶㊷㊸㊹㊺㊻㊼㊽㊾㊿</td> </tr> <tr> <td>中央制御室端子盤</td> <td>中央制御室端子盤(11)</td> <td>C-02-4</td> <td>制御層</td> <td>0.000</td> <td>②③④⑤⑥⑦⑧⑨⑩⑪⑫⑬⑭⑮⑯⑰⑱⑲⑳㉑㉒㉓㉔㉕㉖㉗㉘㉙㉚㉛㉜㉝㉞㉟㊱㊲㊳㊴㊵㊶㊷㊸㊹㊺㊻㊼㊽㊾㊿</td> </tr> <tr> <td>中央制御室端子盤</td> <td>中央制御室端子盤(12)</td> <td>C-02-4</td> <td>制御層</td> <td>0.000</td> <td>②③④⑤⑥⑦⑧⑨⑩⑪⑫⑬⑭⑮⑯⑰⑱⑲⑳㉑㉒㉓㉔㉕㉖㉗㉘㉙㉚㉛㉜㉝㉞㉟㊱㊲㊳㊴㊵㊶㊷㊸㊹㊺㊻㊼㊽㊾㊿</td> </tr> <tr> <td>中央制御室端子盤</td> <td>中央制御室端子盤(13)</td> <td>C-02-4</td> <td>制御層</td> <td>0.000</td> <td>②③④⑤⑥⑦⑧⑨⑩⑪⑫⑬⑭⑮⑯⑰⑱⑲⑳㉑㉒㉓㉔㉕㉖㉗㉘㉙㉚㉛㉜㉝㉞㉟㊱㊲㊳㊴㊵㊶㊷㊸㊹㊺㊻㊼㊽㊾㊿</td> </tr> <tr> <td>中央制御室端子盤</td> <td>中央制御室端子盤(14)</td> <td>C-02-4</td> <td>制御層</td> <td>0.000</td> <td>②③④⑤⑥⑦⑧⑨⑩⑪⑫⑬⑭⑮⑯⑰⑱⑲⑳㉑㉒㉓㉔㉕㉖㉗㉘㉙㉚㉛㉜㉝㉞㉟㊱㊲㊳㊴㊵㊶㊷㊸㊹㊺㊻㊼㊽㊾㊿</td> </tr> <tr> <td>中央制御室端子盤</td> <td>中央制御室端子盤(15)</td> <td>C-02-4</td> <td>制御層</td> <td>0.000</td> <td>②③④⑤⑥⑦⑧⑨⑩⑪⑫⑬⑭⑮⑯⑰⑱⑲⑳㉑㉒㉓㉔㉕㉖㉗㉘㉙㉚㉛㉜㉝㉞㉟㊱㊲㊳㊴㊵㊶㊷㊸㊹㊺㊻㊼㊽㊾㊿</td> </tr> <tr> <td>中央制御室端子盤</td> <td>中央制御室端子盤(16)</td> <td>C-02-4</td> <td>制御層</td> <td>0.000</td> <td>②③④⑤⑥⑦⑧⑨⑩⑪⑫⑬⑭⑮⑯⑰⑱⑲⑳㉑㉒㉓㉔㉕㉖㉗㉘㉙㉚㉛㉜㉝㉞㉟㊱㊲㊳㊴㊵㊶㊷㊸㊹㊺㊻㊼㊽㊾㊿</td> </tr> <tr> <td>中央制御室端子盤</td> <td>中央制御室端子盤(17)</td> <td>C-02-4</td> <td>制御層</td> <td>0.000</td> <td>②③④⑤⑥⑦⑧⑨⑩⑪⑫⑬⑭⑮⑯⑰⑱⑲⑳㉑㉒㉓㉔㉕㉖㉗㉘㉙㉚㉛㉜㉝㉞㉟㊱㊲㊳㊴㊵㊶㊷㊸㊹㊺㊻㊼㊽㊾㊿</td> </tr> <tr> <td>中央制御室端子盤</td> <td>中央制御室端子盤(18)</td> <td>C-02-4</td> <td>制御層</td> <td>0.000</td> <td>②③④⑤⑥⑦⑧⑨⑩⑪⑫⑬⑭⑮⑯⑰⑱⑲⑳㉑㉒㉓㉔㉕㉖㉗㉘㉙㉚㉛㉜㉝㉞㉟㊱㊲㊳㊴㊵㊶㊷㊸㊹㊺㊻㊼㊽㊾㊿</td> </tr> <tr> <td>中央制御室端子盤</td> <td>中央制御室端子盤(19)</td> <td>C-02-4</td> <td>制御層</td> <td>0.000</td> <td>②③④⑤⑥⑦⑧⑨⑩⑪⑫⑬⑭⑮⑯⑰⑱⑲⑳㉑㉒㉓㉔㉕㉖㉗㉘㉙㉚㉛㉜㉝㉞㉟㊱㊲㊳㊴㊵㊶㊷㊸㊹㊺㊻㊼㊽㊾㊿</td> </tr> <tr> <td>中央制御室端子盤</td> <td>中央制御室端子盤(20)</td> <td>C-02-4</td> <td>制御層</td> <td>0.000</td> <td>②③④⑤⑥⑦⑧⑨⑩⑪⑫⑬⑭⑮⑯⑰⑱⑲⑳㉑㉒㉓㉔㉕㉖㉗㉘㉙㉚㉛㉜㉝㉞㉟㊱㊲㊳㊴㊵㊶㊷㊸㊹㊺㊻㊼㊽㊾㊿</td> </tr> <tr> <td>中央制御室端子盤</td> <td>中央制御室端子盤(21)</td> <td>C-02-4</td> <td>制御層</td> <td>0.000</td> <td>②③④⑤⑥⑦⑧⑨⑩⑪⑫⑬⑭⑮⑯⑰⑱⑲⑳㉑㉒㉓㉔㉕㉖㉗㉘㉙㉚㉛㉜㉝㉞㉟㊱㊲㊳㊴㊵㊶㊷㊸㊹㊺㊻㊼㊽㊾㊿</td> </tr> <tr> <td>中央制御室端子盤</td> <td>中央制御室端子盤(22)</td> <td>C-02-4</td> <td>制御層</td> <td>0.000</td> <td>②③④⑤⑥⑦⑧⑨⑩⑪⑫⑬⑭⑮⑯⑰⑱⑲⑳㉑㉒㉓㉔㉕㉖㉗㉘㉙㉚㉛㉜㉝㉞㉟㊱㊲㊳㊴㊵㊶㊷㊸㊹㊺㊻㊼㊽㊾㊿</td> </tr> <tr> <td>中央制御室端子盤</td> <td>中央制御室端子盤(23)</td> <td>C-02-4</td> <td>制御層</td> <td>0.000</td> <td>②③④⑤⑥⑦⑧⑨⑩⑪⑫⑬⑭⑮⑯⑰⑱⑲⑳㉑㉒㉓㉔㉕㉖㉗㉘㉙㉚㉛㉜㉝㉞㉟㊱㊲㊳㊴㊵㊶㊷㊸㊹㊺㊻㊼㊽㊾㊿</td> </tr> <tr> <td>中央制御室端子盤</td> <td>中央制御室端子盤(24)</td> <td>C-02-4</td> <td>制御層</td> <td>0.000</td> <td>②③④⑤⑥⑦⑧⑨⑩⑪⑫⑬⑭⑮⑯⑰⑱⑲⑳㉑㉒㉓㉔㉕㉖㉗㉘㉙㉚㉛㉜㉝㉞㉟㊱㊲㊳㊴㊵㊶㊷㊸㊹㊺㊻㊼㊽㊾㊿</td> </tr> <tr> <td>中央制御室端子盤</td> <td>中央制御室端子盤(25)</td> <td>C-02-4</td> <td>制御層</td> <td>0.000</td> <td>②③④⑤⑥⑦⑧⑨⑩⑪⑫⑬⑭⑮⑯⑰⑱⑲⑳㉑㉒㉓㉔㉕㉖㉗㉘㉙㉚㉛㉜㉝㉞㉟㊱㊲㊳㊴㊵㊶㊷㊸㊹㊺㊻㊼㊽㊾㊿</td> </tr> <tr> <td>中央制御室端子盤</td> <td>中央制御室端子盤(26)</td> <td>C-02-4</td> <td>制御層</td> <td>0.000</td> <td>②③④⑤⑥⑦⑧⑨⑩⑪⑫⑬⑭⑮⑯⑰⑱⑲⑳㉑㉒㉓㉔㉕㉖㉗㉘㉙㉚㉛㉜㉝㉞㉟㊱㊲㊳㊴㊵㊶㊷㊸㊹㊺㊻㊼㊽㊾㊿</td> </tr> <tr> <td>中央制御室端子盤</td> <td>中央制御室端子盤(27)</td> <td>C-02-4</td> <td>制御層</td> <td>0.000</td> <td>②③④⑤⑥⑦⑧⑨⑩⑪⑫⑬⑭⑮⑯⑰⑱⑲⑳㉑㉒㉓㉔㉕㉖㉗㉘㉙㉚㉛㉜㉝㉞㉟㊱㊲㊳㊴㊵㊶㊷㊸㊹㊺㊻㊼㊽㊾㊿</td> </tr> </tbody> </table> <p>※1：注水により機能喪失する床面からの高さ（注水高さ0.600mを考慮） ※2：①緊急停止機能 ②緊急停止機能 ③緊急停止機能 ④緊急停止機能 ⑤緊急停止機能 ⑥緊急停止機能 ⑦緊急停止機能 ⑧緊急停止機能 ⑨緊急停止機能 ⑩緊急停止機能 ⑪緊急停止機能 ⑫緊急停止機能 ⑬緊急停止機能 ⑭緊急停止機能 ⑮緊急停止機能 ⑯緊急停止機能 ⑰緊急停止機能 ⑱緊急停止機能 ⑲緊急停止機能 ⑳緊急停止機能 ㉑緊急停止機能 ㉒緊急停止機能 ㉓緊急停止機能 ㉔緊急停止機能 ㉕緊急停止機能 ㉖緊急停止機能 ㉗緊急停止機能 ㉘緊急停止機能 ㉙緊急停止機能 ㉚緊急停止機能 ㉛緊急停止機能 ㉜緊急停止機能 ㉝緊急停止機能 ㉞緊急停止機能 ㉟緊急停止機能 ㊱緊急停止機能 ㊲緊急停止機能 ㊳緊急停止機能 ㊴緊急停止機能 ㊵緊急停止機能 ㊶緊急停止機能 ㊷緊急停止機能 ㊸緊急停止機能 ㊹緊急停止機能 ㊺緊急停止機能 ㊻緊急停止機能 ㊼緊急停止機能 ㊽緊急停止機能 ㊾緊急停止機能 ㊿緊急停止機能</p>	系統	設備	区画番号	設置層	E.L. ^{※1} (m)	機能 ^{※2}	機軸空調機用非常用冷却水	機軸空調機用非常用冷却水(1)	B-02-4	原子炉建屋 付属層	0.600	②③④⑤⑥⑦⑧⑨⑩⑪⑫⑬⑭⑮⑯⑰⑱⑲⑳㉑㉒㉓㉔㉕㉖㉗㉘㉙㉚㉛㉜㉝㉞㉟㊱㊲㊳㊴㊵㊶㊷㊸㊹㊺㊻㊼㊽㊾㊿	機軸空調機用非常用冷却水	機軸空調機用非常用冷却水(2)	B-02-4	原子炉建屋 付属層	0.600	②③④⑤⑥⑦⑧⑨⑩⑪⑫⑬⑭⑮⑯⑰⑱⑲⑳㉑㉒㉓㉔㉕㉖㉗㉘㉙㉚㉛㉜㉝㉞㉟㊱㊲㊳㊴㊵㊶㊷㊸㊹㊺㊻㊼㊽㊾㊿	機軸空調機用非常用冷却水	機軸空調機用非常用冷却水(3)	B-02-4	原子炉建屋 付属層	1.175	②③④⑤⑥⑦⑧⑨⑩⑪⑫⑬⑭⑮⑯⑰⑱⑲⑳㉑㉒㉓㉔㉕㉖㉗㉘㉙㉚㉛㉜㉝㉞㉟㊱㊲㊳㊴㊵㊶㊷㊸㊹㊺㊻㊼㊽㊾㊿	中央制御室制御盤	中央制御室制御盤(1)	C-02-1	制御層	0.000	②③④⑤⑥⑦⑧⑨⑩⑪⑫⑬⑭⑮⑯⑰⑱⑲⑳㉑㉒㉓㉔㉕㉖㉗㉘㉙㉚㉛㉜㉝㉞㉟㊱㊲㊳㊴㊵㊶㊷㊸㊹㊺㊻㊼㊽㊾㊿	中央制御室端子盤	中央制御室端子盤(1)	C-02-1	制御層	0.200	②③④⑤⑥⑦⑧⑨⑩⑪⑫⑬⑭⑮⑯⑰⑱⑲⑳㉑㉒㉓㉔㉕㉖㉗㉘㉙㉚㉛㉜㉝㉞㉟㊱㊲㊳㊴㊵㊶㊷㊸㊹㊺㊻㊼㊽㊾㊿	中央制御室端子盤	中央制御室端子盤(2)	C-02-2	制御層	0.200	②③④⑤⑥⑦⑧⑨⑩⑪⑫⑬⑭⑮⑯⑰⑱⑲⑳㉑㉒㉓㉔㉕㉖㉗㉘㉙㉚㉛㉜㉝㉞㉟㊱㊲㊳㊴㊵㊶㊷㊸㊹㊺㊻㊼㊽㊾㊿	中央制御室端子盤	中央制御室端子盤(3)	C-02-4	制御層	0.200	②③④⑤⑥⑦⑧⑨⑩⑪⑫⑬⑭⑮⑯⑰⑱⑲⑳㉑㉒㉓㉔㉕㉖㉗㉘㉙㉚㉛㉜㉝㉞㉟㊱㊲㊳㊴㊵㊶㊷㊸㊹㊺㊻㊼㊽㊾㊿	中央制御室端子盤	中央制御室端子盤(4)	C-02-4	制御層	0.200	②③④⑤⑥⑦⑧⑨⑩⑪⑫⑬⑭⑮⑯⑰⑱⑲⑳㉑㉒㉓㉔㉕㉖㉗㉘㉙㉚㉛㉜㉝㉞㉟㊱㊲㊳㊴㊵㊶㊷㊸㊹㊺㊻㊼㊽㊾㊿	中央制御室端子盤	中央制御室端子盤(5)	C-02-4	制御層	0.000	②③④⑤⑥⑦⑧⑨⑩⑪⑫⑬⑭⑮⑯⑰⑱⑲⑳㉑㉒㉓㉔㉕㉖㉗㉘㉙㉚㉛㉜㉝㉞㉟㊱㊲㊳㊴㊵㊶㊷㊸㊹㊺㊻㊼㊽㊾㊿	中央制御室端子盤	中央制御室端子盤(6)	C-02-4	制御層	0.000	②③④⑤⑥⑦⑧⑨⑩⑪⑫⑬⑭⑮⑯⑰⑱⑲⑳㉑㉒㉓㉔㉕㉖㉗㉘㉙㉚㉛㉜㉝㉞㉟㊱㊲㊳㊴㊵㊶㊷㊸㊹㊺㊻㊼㊽㊾㊿	中央制御室端子盤	中央制御室端子盤(7)	C-02-4	制御層	0.000	②③④⑤⑥⑦⑧⑨⑩⑪⑫⑬⑭⑮⑯⑰⑱⑲⑳㉑㉒㉓㉔㉕㉖㉗㉘㉙㉚㉛㉜㉝㉞㉟㊱㊲㊳㊴㊵㊶㊷㊸㊹㊺㊻㊼㊽㊾㊿	中央制御室端子盤	中央制御室端子盤(8)	C-02-4	制御層	0.000	②③④⑤⑥⑦⑧⑨⑩⑪⑫⑬⑭⑮⑯⑰⑱⑲⑳㉑㉒㉓㉔㉕㉖㉗㉘㉙㉚㉛㉜㉝㉞㉟㊱㊲㊳㊴㊵㊶㊷㊸㊹㊺㊻㊼㊽㊾㊿	中央制御室端子盤	中央制御室端子盤(9)	C-02-4	制御層	0.000	②③④⑤⑥⑦⑧⑨⑩⑪⑫⑬⑭⑮⑯⑰⑱⑲⑳㉑㉒㉓㉔㉕㉖㉗㉘㉙㉚㉛㉜㉝㉞㉟㊱㊲㊳㊴㊵㊶㊷㊸㊹㊺㊻㊼㊽㊾㊿	中央制御室端子盤	中央制御室端子盤(10)	C-02-4	制御層	0.000	②③④⑤⑥⑦⑧⑨⑩⑪⑫⑬⑭⑮⑯⑰⑱⑲⑳㉑㉒㉓㉔㉕㉖㉗㉘㉙㉚㉛㉜㉝㉞㉟㊱㊲㊳㊴㊵㊶㊷㊸㊹㊺㊻㊼㊽㊾㊿	中央制御室端子盤	中央制御室端子盤(11)	C-02-4	制御層	0.000	②③④⑤⑥⑦⑧⑨⑩⑪⑫⑬⑭⑮⑯⑰⑱⑲⑳㉑㉒㉓㉔㉕㉖㉗㉘㉙㉚㉛㉜㉝㉞㉟㊱㊲㊳㊴㊵㊶㊷㊸㊹㊺㊻㊼㊽㊾㊿	中央制御室端子盤	中央制御室端子盤(12)	C-02-4	制御層	0.000	②③④⑤⑥⑦⑧⑨⑩⑪⑫⑬⑭⑮⑯⑰⑱⑲⑳㉑㉒㉓㉔㉕㉖㉗㉘㉙㉚㉛㉜㉝㉞㉟㊱㊲㊳㊴㊵㊶㊷㊸㊹㊺㊻㊼㊽㊾㊿	中央制御室端子盤	中央制御室端子盤(13)	C-02-4	制御層	0.000	②③④⑤⑥⑦⑧⑨⑩⑪⑫⑬⑭⑮⑯⑰⑱⑲⑳㉑㉒㉓㉔㉕㉖㉗㉘㉙㉚㉛㉜㉝㉞㉟㊱㊲㊳㊴㊵㊶㊷㊸㊹㊺㊻㊼㊽㊾㊿	中央制御室端子盤	中央制御室端子盤(14)	C-02-4	制御層	0.000	②③④⑤⑥⑦⑧⑨⑩⑪⑫⑬⑭⑮⑯⑰⑱⑲⑳㉑㉒㉓㉔㉕㉖㉗㉘㉙㉚㉛㉜㉝㉞㉟㊱㊲㊳㊴㊵㊶㊷㊸㊹㊺㊻㊼㊽㊾㊿	中央制御室端子盤	中央制御室端子盤(15)	C-02-4	制御層	0.000	②③④⑤⑥⑦⑧⑨⑩⑪⑫⑬⑭⑮⑯⑰⑱⑲⑳㉑㉒㉓㉔㉕㉖㉗㉘㉙㉚㉛㉜㉝㉞㉟㊱㊲㊳㊴㊵㊶㊷㊸㊹㊺㊻㊼㊽㊾㊿	中央制御室端子盤	中央制御室端子盤(16)	C-02-4	制御層	0.000	②③④⑤⑥⑦⑧⑨⑩⑪⑫⑬⑭⑮⑯⑰⑱⑲⑳㉑㉒㉓㉔㉕㉖㉗㉘㉙㉚㉛㉜㉝㉞㉟㊱㊲㊳㊴㊵㊶㊷㊸㊹㊺㊻㊼㊽㊾㊿	中央制御室端子盤	中央制御室端子盤(17)	C-02-4	制御層	0.000	②③④⑤⑥⑦⑧⑨⑩⑪⑫⑬⑭⑮⑯⑰⑱⑲⑳㉑㉒㉓㉔㉕㉖㉗㉘㉙㉚㉛㉜㉝㉞㉟㊱㊲㊳㊴㊵㊶㊷㊸㊹㊺㊻㊼㊽㊾㊿	中央制御室端子盤	中央制御室端子盤(18)	C-02-4	制御層	0.000	②③④⑤⑥⑦⑧⑨⑩⑪⑫⑬⑭⑮⑯⑰⑱⑲⑳㉑㉒㉓㉔㉕㉖㉗㉘㉙㉚㉛㉜㉝㉞㉟㊱㊲㊳㊴㊵㊶㊷㊸㊹㊺㊻㊼㊽㊾㊿	中央制御室端子盤	中央制御室端子盤(19)	C-02-4	制御層	0.000	②③④⑤⑥⑦⑧⑨⑩⑪⑫⑬⑭⑮⑯⑰⑱⑲⑳㉑㉒㉓㉔㉕㉖㉗㉘㉙㉚㉛㉜㉝㉞㉟㊱㊲㊳㊴㊵㊶㊷㊸㊹㊺㊻㊼㊽㊾㊿	中央制御室端子盤	中央制御室端子盤(20)	C-02-4	制御層	0.000	②③④⑤⑥⑦⑧⑨⑩⑪⑫⑬⑭⑮⑯⑰⑱⑲⑳㉑㉒㉓㉔㉕㉖㉗㉘㉙㉚㉛㉜㉝㉞㉟㊱㊲㊳㊴㊵㊶㊷㊸㊹㊺㊻㊼㊽㊾㊿	中央制御室端子盤	中央制御室端子盤(21)	C-02-4	制御層	0.000	②③④⑤⑥⑦⑧⑨⑩⑪⑫⑬⑭⑮⑯⑰⑱⑲⑳㉑㉒㉓㉔㉕㉖㉗㉘㉙㉚㉛㉜㉝㉞㉟㊱㊲㊳㊴㊵㊶㊷㊸㊹㊺㊻㊼㊽㊾㊿	中央制御室端子盤	中央制御室端子盤(22)	C-02-4	制御層	0.000	②③④⑤⑥⑦⑧⑨⑩⑪⑫⑬⑭⑮⑯⑰⑱⑲⑳㉑㉒㉓㉔㉕㉖㉗㉘㉙㉚㉛㉜㉝㉞㉟㊱㊲㊳㊴㊵㊶㊷㊸㊹㊺㊻㊼㊽㊾㊿	中央制御室端子盤	中央制御室端子盤(23)	C-02-4	制御層	0.000	②③④⑤⑥⑦⑧⑨⑩⑪⑫⑬⑭⑮⑯⑰⑱⑲⑳㉑㉒㉓㉔㉕㉖㉗㉘㉙㉚㉛㉜㉝㉞㉟㊱㊲㊳㊴㊵㊶㊷㊸㊹㊺㊻㊼㊽㊾㊿	中央制御室端子盤	中央制御室端子盤(24)	C-02-4	制御層	0.000	②③④⑤⑥⑦⑧⑨⑩⑪⑫⑬⑭⑮⑯⑰⑱⑲⑳㉑㉒㉓㉔㉕㉖㉗㉘㉙㉚㉛㉜㉝㉞㉟㊱㊲㊳㊴㊵㊶㊷㊸㊹㊺㊻㊼㊽㊾㊿	中央制御室端子盤	中央制御室端子盤(25)	C-02-4	制御層	0.000	②③④⑤⑥⑦⑧⑨⑩⑪⑫⑬⑭⑮⑯⑰⑱⑲⑳㉑㉒㉓㉔㉕㉖㉗㉘㉙㉚㉛㉜㉝㉞㉟㊱㊲㊳㊴㊵㊶㊷㊸㊹㊺㊻㊼㊽㊾㊿	中央制御室端子盤	中央制御室端子盤(26)	C-02-4	制御層	0.000	②③④⑤⑥⑦⑧⑨⑩⑪⑫⑬⑭⑮⑯⑰⑱⑲⑳㉑㉒㉓㉔㉕㉖㉗㉘㉙㉚㉛㉜㉝㉞㉟㊱㊲㊳㊴㊵㊶㊷㊸㊹㊺㊻㊼㊽㊾㊿	中央制御室端子盤	中央制御室端子盤(27)	C-02-4	制御層	0.000	②③④⑤⑥⑦⑧⑨⑩⑪⑫⑬⑭⑮⑯⑰⑱⑲⑳㉑㉒㉓㉔㉕㉖㉗㉘㉙㉚㉛㉜㉝㉞㉟㊱㊲㊳㊴㊵㊶㊷㊸㊹㊺㊻㊼㊽㊾㊿	<p style="text-align: center;">表1 防護対象設備一覧 (20/35)</p> <table border="1" style="width: 100%; border-collapse: collapse;"> <thead> <tr> <th>系統</th> <th>設備</th> <th>区画番号</th> <th>設置層</th> <th>基本設定高さ^{※1}(m)</th> <th>個別測定高さ^{※2}(m)</th> <th>設定箇所</th> <th>安全機能</th> </tr> </thead> <tbody> <tr> <td>高圧注入系</td> <td>A-高圧注入ポンプ第2ミニロー弁 (3V-SI-015A)</td> <td>3AB-K-22</td> <td>原子炉補助建屋</td> <td>0.72</td> <td>0.72</td> <td>基本</td> <td>②④</td> </tr> <tr> <td>高圧注入系</td> <td>B-高圧注入ポンプ第1ミニロー弁 (3V-SI-014B)</td> <td>3AB-K-12</td> <td>原子炉補助建屋</td> <td>0.72</td> <td>0.73</td> <td>基本</td> <td>②④</td> </tr> <tr> <td>高圧注入系</td> <td>B-高圧注入ポンプ第2ミニロー弁 (3V-SI-015B)</td> <td>3AB-K-12</td> <td>原子炉補助建屋</td> <td>0.72</td> <td>0.73</td> <td>基本</td> <td>②④</td> </tr> <tr> <td>高圧注入系</td> <td>A-高圧注入ポンプ出口C/V外側隔離弁 (3V-SI-020A)</td> <td>3AB-K-21</td> <td>原子炉補助建屋</td> <td>0.93</td> <td>1.01</td> <td>個別</td> <td>②④</td> </tr> <tr> <td>高圧注入系</td> <td>B-高圧注入ポンプ出口C/V外側隔離弁 (3V-SI-020B)</td> <td>3AB-K-13</td> <td>原子炉補助建屋</td> <td>0.93</td> <td>1.00</td> <td>個別</td> <td>②④</td> </tr> <tr> <td>高圧注入系</td> <td>ほう酸注入タンク入口弁A (3V-SI-032A)</td> <td>3AB-F-23</td> <td>原子炉補助建屋</td> <td>0.89</td> <td>0.98</td> <td>基本</td> <td>②④</td> </tr> <tr> <td>高圧注入系</td> <td>ほう酸注入タンク入口弁B (3V-SI-032B)</td> <td>3AB-F-23</td> <td>原子炉補助建屋</td> <td>0.89</td> <td>0.98</td> <td>基本</td> <td>②④</td> </tr> <tr> <td>高圧注入系</td> <td>ほう酸注入タンク出口C/V外側隔離弁A (3V-SI-036A)</td> <td>3RB-E-2</td> <td>原子炉建屋</td> <td>0.60</td> <td>1.10</td> <td>基本</td> <td>②④⑤</td> </tr> <tr> <td>高圧注入系</td> <td>ほう酸注入タンク出口C/V外側隔離弁B (3V-SI-036B)</td> <td>3RB-E-2</td> <td>原子炉建屋</td> <td>0.60</td> <td>1.09</td> <td>基本</td> <td>②④⑤</td> </tr> <tr> <td>高圧注入系</td> <td>補助高圧注入ラインC/V外側隔離弁 (3V-SI-051)</td> <td>3RB-E-2</td> <td>原子炉建屋</td> <td>0.60</td> <td>1.10</td> <td>基本</td> <td>④⑤</td> </tr> <tr> <td>高圧注入系</td> <td>A-安全注入ポンプ再循環サンプ側入口C/V外側隔離弁 (3V-SI-064A)</td> <td>3RB-J-2</td> <td>原子炉建屋</td> <td>2.90</td> <td>3.86</td> <td>基本</td> <td>④⑤</td> </tr> <tr> <td>高圧注入系</td> <td>B-安全注入ポンプ再循環サンプ側入口C/V外側隔離弁 (3V-SI-064B)</td> <td>3RB-J-1</td> <td>原子炉建屋</td> <td>2.90</td> <td>4.07</td> <td>個別</td> <td>④⑤</td> </tr> <tr> <td>燃料取替用水系</td> <td>A-燃料取替用水ポンプ (SRFP1A)</td> <td>3RB-D-1</td> <td>原子炉建屋</td> <td>0.51</td> <td>0.53</td> <td>基本</td> <td>⑨</td> </tr> </tbody> </table> <p>※1：保守的に機能喪失すると仮定した床面からの高さ ※2：注水により機能喪失する床面からの高さ ①緊急時停止機能 ②緊急時停止機能 ③緊急時停止機能 ④緊急時停止機能 ⑤緊急時停止機能 ⑥緊急時停止機能 ⑦緊急時停止機能 ⑧緊急時停止機能 ⑨緊急時停止機能 ⑩緊急時停止機能 ⑪緊急時停止機能 ⑫緊急時停止機能 ⑬緊急時停止機能 ⑭緊急時停止機能 ⑮緊急時停止機能 ⑯緊急時停止機能 ⑰緊急時停止機能 ⑱緊急時停止機能 ⑲緊急時停止機能 ⑳緊急時停止機能 ㉑緊急時停止機能 ㉒緊急時停止機能 ㉓緊急時停止機能 ㉔緊急時停止機能 ㉕緊急時停止機能 ㉖緊急時停止機能 ㉗緊急時停止機能 ㉘緊急時停止機能 ㉙緊急時停止機能 ㉚緊急時停止機能 ㉛緊急時停止機能 ㉜緊急時停止機能 ㉝緊急時停止機能 ㉞緊急時停止機能 ㉟緊急時停止機能 ㊱緊急時停止機能 ㊲緊急時停止機能 ㊳緊急時停止機能 ㊴緊急時停止機能 ㊵緊急時停止機能 ㊶緊急時停止機能 ㊷緊急時停止機能 ㊸緊急時停止機能 ㊹緊急時停止機能 ㊺緊急時停止機能 ㊻緊急時停止機能 ㊼緊急時停止機能 ㊽緊急時停止機能 ㊾緊急時停止機能 ㊿緊急時停止機能</p>	系統	設備	区画番号	設置層	基本設定高さ ^{※1} (m)	個別測定高さ ^{※2} (m)	設定箇所	安全機能	高圧注入系	A-高圧注入ポンプ第2ミニロー弁 (3V-SI-015A)	3AB-K-22	原子炉補助建屋	0.72	0.72	基本	②④	高圧注入系	B-高圧注入ポンプ第1ミニロー弁 (3V-SI-014B)	3AB-K-12	原子炉補助建屋	0.72	0.73	基本	②④	高圧注入系	B-高圧注入ポンプ第2ミニロー弁 (3V-SI-015B)	3AB-K-12	原子炉補助建屋	0.72	0.73	基本	②④	高圧注入系	A-高圧注入ポンプ出口C/V外側隔離弁 (3V-SI-020A)	3AB-K-21	原子炉補助建屋	0.93	1.01	個別	②④	高圧注入系	B-高圧注入ポンプ出口C/V外側隔離弁 (3V-SI-020B)	3AB-K-13	原子炉補助建屋	0.93	1.00	個別	②④	高圧注入系	ほう酸注入タンク入口弁A (3V-SI-032A)	3AB-F-23	原子炉補助建屋	0.89	0.98	基本	②④	高圧注入系	ほう酸注入タンク入口弁B (3V-SI-032B)	3AB-F-23	原子炉補助建屋	0.89	0.98	基本	②④	高圧注入系	ほう酸注入タンク出口C/V外側隔離弁A (3V-SI-036A)	3RB-E-2	原子炉建屋	0.60	1.10	基本	②④⑤	高圧注入系	ほう酸注入タンク出口C/V外側隔離弁B (3V-SI-036B)	3RB-E-2	原子炉建屋	0.60	1.09	基本	②④⑤	高圧注入系	補助高圧注入ラインC/V外側隔離弁 (3V-SI-051)	3RB-E-2	原子炉建屋	0.60	1.10	基本	④⑤	高圧注入系	A-安全注入ポンプ再循環サンプ側入口C/V外側隔離弁 (3V-SI-064A)	3RB-J-2	原子炉建屋	2.90	3.86	基本	④⑤	高圧注入系	B-安全注入ポンプ再循環サンプ側入口C/V外側隔離弁 (3V-SI-064B)	3RB-J-1	原子炉建屋	2.90	4.07	個別	④⑤	燃料取替用水系	A-燃料取替用水ポンプ (SRFP1A)	3RB-D-1	原子炉建屋	0.51	0.53	基本	⑨	<p>【女川】 <u>記載方針の相違</u> <u>設計方針の相違</u></p> <p>・泊では評価ガイドの要求に則り、機能喪失高さは、保守的に機能喪失すると仮定した高さである「評価高さ（基本設定箇所）」を標準としているが、評価高さで没水してしまう機器については「実力高さ（個別測定箇所）」を適用している。</p> <p>上記を踏まえ、表1には防護対象設備の「基本設定箇所」と「個別測定箇所」の機能喪失高さを併記し、どちらを採用しているか明確となるよう設定箇所を記載している。（島根2号炉、柏崎6,7号炉と同様）</p> <p>・設備名称等については、炉型の違い及びプラント設計の違いによる相違</p> <p>・安全機能に関して、炉型の相違により機能名称が異なるが、「止める」「冷やす」「閉じ込める」「ビット冷却」の達成を目的とした機能であることに相違はない。</p>
系統	設備	区画番号	設置層	E.L. ^{※1} (m)	機能 ^{※2}																																																																																																																																																																																																																																																																																																														
機軸空調機用非常用冷却水	機軸空調機用非常用冷却水(1)	B-02-4	原子炉建屋 付属層	0.600	②③④⑤⑥⑦⑧⑨⑩⑪⑫⑬⑭⑮⑯⑰⑱⑲⑳㉑㉒㉓㉔㉕㉖㉗㉘㉙㉚㉛㉜㉝㉞㉟㊱㊲㊳㊴㊵㊶㊷㊸㊹㊺㊻㊼㊽㊾㊿																																																																																																																																																																																																																																																																																																														
機軸空調機用非常用冷却水	機軸空調機用非常用冷却水(2)	B-02-4	原子炉建屋 付属層	0.600	②③④⑤⑥⑦⑧⑨⑩⑪⑫⑬⑭⑮⑯⑰⑱⑲⑳㉑㉒㉓㉔㉕㉖㉗㉘㉙㉚㉛㉜㉝㉞㉟㊱㊲㊳㊴㊵㊶㊷㊸㊹㊺㊻㊼㊽㊾㊿																																																																																																																																																																																																																																																																																																														
機軸空調機用非常用冷却水	機軸空調機用非常用冷却水(3)	B-02-4	原子炉建屋 付属層	1.175	②③④⑤⑥⑦⑧⑨⑩⑪⑫⑬⑭⑮⑯⑰⑱⑲⑳㉑㉒㉓㉔㉕㉖㉗㉘㉙㉚㉛㉜㉝㉞㉟㊱㊲㊳㊴㊵㊶㊷㊸㊹㊺㊻㊼㊽㊾㊿																																																																																																																																																																																																																																																																																																														
中央制御室制御盤	中央制御室制御盤(1)	C-02-1	制御層	0.000	②③④⑤⑥⑦⑧⑨⑩⑪⑫⑬⑭⑮⑯⑰⑱⑲⑳㉑㉒㉓㉔㉕㉖㉗㉘㉙㉚㉛㉜㉝㉞㉟㊱㊲㊳㊴㊵㊶㊷㊸㊹㊺㊻㊼㊽㊾㊿																																																																																																																																																																																																																																																																																																														
中央制御室端子盤	中央制御室端子盤(1)	C-02-1	制御層	0.200	②③④⑤⑥⑦⑧⑨⑩⑪⑫⑬⑭⑮⑯⑰⑱⑲⑳㉑㉒㉓㉔㉕㉖㉗㉘㉙㉚㉛㉜㉝㉞㉟㊱㊲㊳㊴㊵㊶㊷㊸㊹㊺㊻㊼㊽㊾㊿																																																																																																																																																																																																																																																																																																														
中央制御室端子盤	中央制御室端子盤(2)	C-02-2	制御層	0.200	②③④⑤⑥⑦⑧⑨⑩⑪⑫⑬⑭⑮⑯⑰⑱⑲⑳㉑㉒㉓㉔㉕㉖㉗㉘㉙㉚㉛㉜㉝㉞㉟㊱㊲㊳㊴㊵㊶㊷㊸㊹㊺㊻㊼㊽㊾㊿																																																																																																																																																																																																																																																																																																														
中央制御室端子盤	中央制御室端子盤(3)	C-02-4	制御層	0.200	②③④⑤⑥⑦⑧⑨⑩⑪⑫⑬⑭⑮⑯⑰⑱⑲⑳㉑㉒㉓㉔㉕㉖㉗㉘㉙㉚㉛㉜㉝㉞㉟㊱㊲㊳㊴㊵㊶㊷㊸㊹㊺㊻㊼㊽㊾㊿																																																																																																																																																																																																																																																																																																														
中央制御室端子盤	中央制御室端子盤(4)	C-02-4	制御層	0.200	②③④⑤⑥⑦⑧⑨⑩⑪⑫⑬⑭⑮⑯⑰⑱⑲⑳㉑㉒㉓㉔㉕㉖㉗㉘㉙㉚㉛㉜㉝㉞㉟㊱㊲㊳㊴㊵㊶㊷㊸㊹㊺㊻㊼㊽㊾㊿																																																																																																																																																																																																																																																																																																														
中央制御室端子盤	中央制御室端子盤(5)	C-02-4	制御層	0.000	②③④⑤⑥⑦⑧⑨⑩⑪⑫⑬⑭⑮⑯⑰⑱⑲⑳㉑㉒㉓㉔㉕㉖㉗㉘㉙㉚㉛㉜㉝㉞㉟㊱㊲㊳㊴㊵㊶㊷㊸㊹㊺㊻㊼㊽㊾㊿																																																																																																																																																																																																																																																																																																														
中央制御室端子盤	中央制御室端子盤(6)	C-02-4	制御層	0.000	②③④⑤⑥⑦⑧⑨⑩⑪⑫⑬⑭⑮⑯⑰⑱⑲⑳㉑㉒㉓㉔㉕㉖㉗㉘㉙㉚㉛㉜㉝㉞㉟㊱㊲㊳㊴㊵㊶㊷㊸㊹㊺㊻㊼㊽㊾㊿																																																																																																																																																																																																																																																																																																														
中央制御室端子盤	中央制御室端子盤(7)	C-02-4	制御層	0.000	②③④⑤⑥⑦⑧⑨⑩⑪⑫⑬⑭⑮⑯⑰⑱⑲⑳㉑㉒㉓㉔㉕㉖㉗㉘㉙㉚㉛㉜㉝㉞㉟㊱㊲㊳㊴㊵㊶㊷㊸㊹㊺㊻㊼㊽㊾㊿																																																																																																																																																																																																																																																																																																														
中央制御室端子盤	中央制御室端子盤(8)	C-02-4	制御層	0.000	②③④⑤⑥⑦⑧⑨⑩⑪⑫⑬⑭⑮⑯⑰⑱⑲⑳㉑㉒㉓㉔㉕㉖㉗㉘㉙㉚㉛㉜㉝㉞㉟㊱㊲㊳㊴㊵㊶㊷㊸㊹㊺㊻㊼㊽㊾㊿																																																																																																																																																																																																																																																																																																														
中央制御室端子盤	中央制御室端子盤(9)	C-02-4	制御層	0.000	②③④⑤⑥⑦⑧⑨⑩⑪⑫⑬⑭⑮⑯⑰⑱⑲⑳㉑㉒㉓㉔㉕㉖㉗㉘㉙㉚㉛㉜㉝㉞㉟㊱㊲㊳㊴㊵㊶㊷㊸㊹㊺㊻㊼㊽㊾㊿																																																																																																																																																																																																																																																																																																														
中央制御室端子盤	中央制御室端子盤(10)	C-02-4	制御層	0.000	②③④⑤⑥⑦⑧⑨⑩⑪⑫⑬⑭⑮⑯⑰⑱⑲⑳㉑㉒㉓㉔㉕㉖㉗㉘㉙㉚㉛㉜㉝㉞㉟㊱㊲㊳㊴㊵㊶㊷㊸㊹㊺㊻㊼㊽㊾㊿																																																																																																																																																																																																																																																																																																														
中央制御室端子盤	中央制御室端子盤(11)	C-02-4	制御層	0.000	②③④⑤⑥⑦⑧⑨⑩⑪⑫⑬⑭⑮⑯⑰⑱⑲⑳㉑㉒㉓㉔㉕㉖㉗㉘㉙㉚㉛㉜㉝㉞㉟㊱㊲㊳㊴㊵㊶㊷㊸㊹㊺㊻㊼㊽㊾㊿																																																																																																																																																																																																																																																																																																														
中央制御室端子盤	中央制御室端子盤(12)	C-02-4	制御層	0.000	②③④⑤⑥⑦⑧⑨⑩⑪⑫⑬⑭⑮⑯⑰⑱⑲⑳㉑㉒㉓㉔㉕㉖㉗㉘㉙㉚㉛㉜㉝㉞㉟㊱㊲㊳㊴㊵㊶㊷㊸㊹㊺㊻㊼㊽㊾㊿																																																																																																																																																																																																																																																																																																														
中央制御室端子盤	中央制御室端子盤(13)	C-02-4	制御層	0.000	②③④⑤⑥⑦⑧⑨⑩⑪⑫⑬⑭⑮⑯⑰⑱⑲⑳㉑㉒㉓㉔㉕㉖㉗㉘㉙㉚㉛㉜㉝㉞㉟㊱㊲㊳㊴㊵㊶㊷㊸㊹㊺㊻㊼㊽㊾㊿																																																																																																																																																																																																																																																																																																														
中央制御室端子盤	中央制御室端子盤(14)	C-02-4	制御層	0.000	②③④⑤⑥⑦⑧⑨⑩⑪⑫⑬⑭⑮⑯⑰⑱⑲⑳㉑㉒㉓㉔㉕㉖㉗㉘㉙㉚㉛㉜㉝㉞㉟㊱㊲㊳㊴㊵㊶㊷㊸㊹㊺㊻㊼㊽㊾㊿																																																																																																																																																																																																																																																																																																														
中央制御室端子盤	中央制御室端子盤(15)	C-02-4	制御層	0.000	②③④⑤⑥⑦⑧⑨⑩⑪⑫⑬⑭⑮⑯⑰⑱⑲⑳㉑㉒㉓㉔㉕㉖㉗㉘㉙㉚㉛㉜㉝㉞㉟㊱㊲㊳㊴㊵㊶㊷㊸㊹㊺㊻㊼㊽㊾㊿																																																																																																																																																																																																																																																																																																														
中央制御室端子盤	中央制御室端子盤(16)	C-02-4	制御層	0.000	②③④⑤⑥⑦⑧⑨⑩⑪⑫⑬⑭⑮⑯⑰⑱⑲⑳㉑㉒㉓㉔㉕㉖㉗㉘㉙㉚㉛㉜㉝㉞㉟㊱㊲㊳㊴㊵㊶㊷㊸㊹㊺㊻㊼㊽㊾㊿																																																																																																																																																																																																																																																																																																														
中央制御室端子盤	中央制御室端子盤(17)	C-02-4	制御層	0.000	②③④⑤⑥⑦⑧⑨⑩⑪⑫⑬⑭⑮⑯⑰⑱⑲⑳㉑㉒㉓㉔㉕㉖㉗㉘㉙㉚㉛㉜㉝㉞㉟㊱㊲㊳㊴㊵㊶㊷㊸㊹㊺㊻㊼㊽㊾㊿																																																																																																																																																																																																																																																																																																														
中央制御室端子盤	中央制御室端子盤(18)	C-02-4	制御層	0.000	②③④⑤⑥⑦⑧⑨⑩⑪⑫⑬⑭⑮⑯⑰⑱⑲⑳㉑㉒㉓㉔㉕㉖㉗㉘㉙㉚㉛㉜㉝㉞㉟㊱㊲㊳㊴㊵㊶㊷㊸㊹㊺㊻㊼㊽㊾㊿																																																																																																																																																																																																																																																																																																														
中央制御室端子盤	中央制御室端子盤(19)	C-02-4	制御層	0.000	②③④⑤⑥⑦⑧⑨⑩⑪⑫⑬⑭⑮⑯⑰⑱⑲⑳㉑㉒㉓㉔㉕㉖㉗㉘㉙㉚㉛㉜㉝㉞㉟㊱㊲㊳㊴㊵㊶㊷㊸㊹㊺㊻㊼㊽㊾㊿																																																																																																																																																																																																																																																																																																														
中央制御室端子盤	中央制御室端子盤(20)	C-02-4	制御層	0.000	②③④⑤⑥⑦⑧⑨⑩⑪⑫⑬⑭⑮⑯⑰⑱⑲⑳㉑㉒㉓㉔㉕㉖㉗㉘㉙㉚㉛㉜㉝㉞㉟㊱㊲㊳㊴㊵㊶㊷㊸㊹㊺㊻㊼㊽㊾㊿																																																																																																																																																																																																																																																																																																														
中央制御室端子盤	中央制御室端子盤(21)	C-02-4	制御層	0.000	②③④⑤⑥⑦⑧⑨⑩⑪⑫⑬⑭⑮⑯⑰⑱⑲⑳㉑㉒㉓㉔㉕㉖㉗㉘㉙㉚㉛㉜㉝㉞㉟㊱㊲㊳㊴㊵㊶㊷㊸㊹㊺㊻㊼㊽㊾㊿																																																																																																																																																																																																																																																																																																														
中央制御室端子盤	中央制御室端子盤(22)	C-02-4	制御層	0.000	②③④⑤⑥⑦⑧⑨⑩⑪⑫⑬⑭⑮⑯⑰⑱⑲⑳㉑㉒㉓㉔㉕㉖㉗㉘㉙㉚㉛㉜㉝㉞㉟㊱㊲㊳㊴㊵㊶㊷㊸㊹㊺㊻㊼㊽㊾㊿																																																																																																																																																																																																																																																																																																														
中央制御室端子盤	中央制御室端子盤(23)	C-02-4	制御層	0.000	②③④⑤⑥⑦⑧⑨⑩⑪⑫⑬⑭⑮⑯⑰⑱⑲⑳㉑㉒㉓㉔㉕㉖㉗㉘㉙㉚㉛㉜㉝㉞㉟㊱㊲㊳㊴㊵㊶㊷㊸㊹㊺㊻㊼㊽㊾㊿																																																																																																																																																																																																																																																																																																														
中央制御室端子盤	中央制御室端子盤(24)	C-02-4	制御層	0.000	②③④⑤⑥⑦⑧⑨⑩⑪⑫⑬⑭⑮⑯⑰⑱⑲⑳㉑㉒㉓㉔㉕㉖㉗㉘㉙㉚㉛㉜㉝㉞㉟㊱㊲㊳㊴㊵㊶㊷㊸㊹㊺㊻㊼㊽㊾㊿																																																																																																																																																																																																																																																																																																														
中央制御室端子盤	中央制御室端子盤(25)	C-02-4	制御層	0.000	②③④⑤⑥⑦⑧⑨⑩⑪⑫⑬⑭⑮⑯⑰⑱⑲⑳㉑㉒㉓㉔㉕㉖㉗㉘㉙㉚㉛㉜㉝㉞㉟㊱㊲㊳㊴㊵㊶㊷㊸㊹㊺㊻㊼㊽㊾㊿																																																																																																																																																																																																																																																																																																														
中央制御室端子盤	中央制御室端子盤(26)	C-02-4	制御層	0.000	②③④⑤⑥⑦⑧⑨⑩⑪⑫⑬⑭⑮⑯⑰⑱⑲⑳㉑㉒㉓㉔㉕㉖㉗㉘㉙㉚㉛㉜㉝㉞㉟㊱㊲㊳㊴㊵㊶㊷㊸㊹㊺㊻㊼㊽㊾㊿																																																																																																																																																																																																																																																																																																														
中央制御室端子盤	中央制御室端子盤(27)	C-02-4	制御層	0.000	②③④⑤⑥⑦⑧⑨⑩⑪⑫⑬⑭⑮⑯⑰⑱⑲⑳㉑㉒㉓㉔㉕㉖㉗㉘㉙㉚㉛㉜㉝㉞㉟㊱㊲㊳㊴㊵㊶㊷㊸㊹㊺㊻㊼㊽㊾㊿																																																																																																																																																																																																																																																																																																														
系統	設備	区画番号	設置層	基本設定高さ ^{※1} (m)	個別測定高さ ^{※2} (m)	設定箇所	安全機能																																																																																																																																																																																																																																																																																																												
高圧注入系	A-高圧注入ポンプ第2ミニロー弁 (3V-SI-015A)	3AB-K-22	原子炉補助建屋	0.72	0.72	基本	②④																																																																																																																																																																																																																																																																																																												
高圧注入系	B-高圧注入ポンプ第1ミニロー弁 (3V-SI-014B)	3AB-K-12	原子炉補助建屋	0.72	0.73	基本	②④																																																																																																																																																																																																																																																																																																												
高圧注入系	B-高圧注入ポンプ第2ミニロー弁 (3V-SI-015B)	3AB-K-12	原子炉補助建屋	0.72	0.73	基本	②④																																																																																																																																																																																																																																																																																																												
高圧注入系	A-高圧注入ポンプ出口C/V外側隔離弁 (3V-SI-020A)	3AB-K-21	原子炉補助建屋	0.93	1.01	個別	②④																																																																																																																																																																																																																																																																																																												
高圧注入系	B-高圧注入ポンプ出口C/V外側隔離弁 (3V-SI-020B)	3AB-K-13	原子炉補助建屋	0.93	1.00	個別	②④																																																																																																																																																																																																																																																																																																												
高圧注入系	ほう酸注入タンク入口弁A (3V-SI-032A)	3AB-F-23	原子炉補助建屋	0.89	0.98	基本	②④																																																																																																																																																																																																																																																																																																												
高圧注入系	ほう酸注入タンク入口弁B (3V-SI-032B)	3AB-F-23	原子炉補助建屋	0.89	0.98	基本	②④																																																																																																																																																																																																																																																																																																												
高圧注入系	ほう酸注入タンク出口C/V外側隔離弁A (3V-SI-036A)	3RB-E-2	原子炉建屋	0.60	1.10	基本	②④⑤																																																																																																																																																																																																																																																																																																												
高圧注入系	ほう酸注入タンク出口C/V外側隔離弁B (3V-SI-036B)	3RB-E-2	原子炉建屋	0.60	1.09	基本	②④⑤																																																																																																																																																																																																																																																																																																												
高圧注入系	補助高圧注入ラインC/V外側隔離弁 (3V-SI-051)	3RB-E-2	原子炉建屋	0.60	1.10	基本	④⑤																																																																																																																																																																																																																																																																																																												
高圧注入系	A-安全注入ポンプ再循環サンプ側入口C/V外側隔離弁 (3V-SI-064A)	3RB-J-2	原子炉建屋	2.90	3.86	基本	④⑤																																																																																																																																																																																																																																																																																																												
高圧注入系	B-安全注入ポンプ再循環サンプ側入口C/V外側隔離弁 (3V-SI-064B)	3RB-J-1	原子炉建屋	2.90	4.07	個別	④⑤																																																																																																																																																																																																																																																																																																												
燃料取替用水系	A-燃料取替用水ポンプ (SRFP1A)	3RB-D-1	原子炉建屋	0.51	0.53	基本	⑨																																																																																																																																																																																																																																																																																																												

赤字：設備、運用又は体制の相違（設計方針の相違）
 青字：記載箇所又は記載内容の相違（記載方針の相違）
 緑字：記載表現、設備名称の相違（実質的な相違なし）

大阪発電所3/4号炉	女川原子力発電所2号炉	泊発電所3号炉	相違理由																																																																																																																																																																																																																																																																																																								
	<p>表1 防護対象設備一覧 (26/27)</p> <table border="1"> <thead> <tr> <th>系統</th> <th>設備</th> <th>区画番号</th> <th>設置建屋</th> <th>基本高さ^{※1}(m)</th> <th>個別測定高さ^{※2}(m)</th> <th>設定箇所</th> <th>安全機能</th> </tr> </thead> <tbody> <tr><td>原子力発電設備</td><td>潤滑油加熱器 (344-3033)</td><td>0-17-15</td><td>原子炉建屋</td><td>0.940</td><td>0.000</td><td>⑥</td><td>④</td></tr> <tr><td>原子力発電設備</td><td>高圧中心冷却器 (344-0061)</td><td>0-17-15</td><td>原子炉建屋</td><td>1.240</td><td>0.000</td><td>⑥</td><td>④</td></tr> <tr><td>原子力発電設備</td><td>高圧中心冷却器 (344-0062)</td><td>0-17-15</td><td>原子炉建屋</td><td>0.960</td><td>0.000</td><td>⑥</td><td>④</td></tr> <tr><td>原子力発電設備</td><td>基本加熱器ポンプ (344-0062)</td><td>0-17-15</td><td>原子炉建屋</td><td>0.900</td><td>0.000</td><td>⑥</td><td>④</td></tr> <tr><td>原子力発電設備</td><td>潤滑油アミンポンプ (344-0240)</td><td>0-17-15</td><td>原子炉建屋</td><td>0.940</td><td>0.000</td><td>⑥</td><td>④</td></tr> <tr><td>原子力発電設備</td><td>潤滑油供給ポンプ (344-0340)</td><td>0-17-15</td><td>原子炉建屋</td><td>0.970</td><td>0.000</td><td>⑥</td><td>④</td></tr> <tr><td>原子力発電設備</td><td>燃料送込ポンプ (344-0290)</td><td>10F-0</td><td>制御ビル</td><td>0.440</td><td>0.000</td><td>⑥</td><td>④</td></tr> <tr><td>原子力発電設備</td><td>オイルパン-燃焼ファン (344-42310)</td><td>0-17-15</td><td>原子炉建屋</td><td>0.970</td><td>0.000</td><td>⑥</td><td>④</td></tr> <tr><td>原子力発電設備</td><td>潤滑油供給ポンプ (344-42320)</td><td>0-17-15</td><td>原子炉建屋</td><td>0.140</td><td>0.000</td><td>⑥</td><td>④</td></tr> <tr><td>原子力発電設備</td><td>燃料ディスタンス (344-42320)</td><td>0-17-15</td><td>原子炉建屋</td><td>0.140</td><td>0.000</td><td>⑥</td><td>④</td></tr> <tr><td>原子力発電設備</td><td>潤滑油供給ポンプ (344-92200)</td><td>0-17-15</td><td>原子炉建屋</td><td>0.900</td><td>0.000</td><td>⑥</td><td>④</td></tr> <tr><td>原子力発電設備</td><td>燃料ハンドル停止位置センサー (344-90001)</td><td>0-17-15</td><td>原子炉建屋</td><td>0.970</td><td>0.000</td><td>⑥</td><td>④</td></tr> <tr><td>原子力発電設備</td><td>機器冷却水ポンプ (344-95001)</td><td>0-17-15</td><td>原子炉建屋</td><td>2.400</td><td>0.000</td><td>⑥</td><td>④</td></tr> <tr><td>原子力発電設備</td><td>機器冷却水ポンプ (344-95002)</td><td>0-17-15</td><td>原子炉建屋</td><td>2.400</td><td>0.000</td><td>⑥</td><td>④</td></tr> <tr><td>原子力発電設備</td><td>機器冷却水ポンプ (344-95114)</td><td>0-17-15</td><td>原子炉建屋</td><td>1.800</td><td>0.000</td><td>⑥</td><td>④</td></tr> <tr><td>原子力発電設備</td><td>機器冷却水ポンプ (344-95114-2)</td><td>0-17-15</td><td>原子炉建屋</td><td>1.800</td><td>0.000</td><td>⑥</td><td>④</td></tr> <tr><td>原子力発電設備</td><td>装置冷却水ポンプ (344-95340)</td><td>0-17-15</td><td>原子炉建屋</td><td>0.140</td><td>0.000</td><td>⑥</td><td>④</td></tr> <tr><td>原子力発電設備</td><td>3FC30系-1号機 (344-904300)</td><td>0-17-15</td><td>原子炉建屋</td><td>0.740</td><td>0.000</td><td>⑥</td><td>④</td></tr> <tr><td>原子力発電設備</td><td>3FC30系-2号機 (344-904311)</td><td>0-17-15</td><td>原子炉建屋</td><td>0.740</td><td>0.000</td><td>⑥</td><td>④</td></tr> <tr><td>原子力発電設備</td><td>3FC30系-3号機 (344-904312)</td><td>0-17-15</td><td>原子炉建屋</td><td>0.200</td><td>0.000</td><td>⑥</td><td>④</td></tr> <tr><td>原子力発電設備</td><td>3FC30系-4号機 (344-904313)</td><td>0-17-15</td><td>原子炉建屋</td><td>0.200</td><td>0.000</td><td>⑥</td><td>④</td></tr> <tr><td>原子力発電設備</td><td>機器冷却水ポンプ (344-95001)</td><td>0-17-15</td><td>原子炉建屋</td><td>2.400</td><td>0.000</td><td>⑥</td><td>④</td></tr> <tr><td>原子力発電設備</td><td>潤滑油アミンポンプ (344-92200)</td><td>0-17-15</td><td>原子炉建屋</td><td>1.800</td><td>0.000</td><td>⑥</td><td>④</td></tr> </tbody> </table>	系統	設備	区画番号	設置建屋	基本高さ ^{※1} (m)	個別測定高さ ^{※2} (m)	設定箇所	安全機能	原子力発電設備	潤滑油加熱器 (344-3033)	0-17-15	原子炉建屋	0.940	0.000	⑥	④	原子力発電設備	高圧中心冷却器 (344-0061)	0-17-15	原子炉建屋	1.240	0.000	⑥	④	原子力発電設備	高圧中心冷却器 (344-0062)	0-17-15	原子炉建屋	0.960	0.000	⑥	④	原子力発電設備	基本加熱器ポンプ (344-0062)	0-17-15	原子炉建屋	0.900	0.000	⑥	④	原子力発電設備	潤滑油アミンポンプ (344-0240)	0-17-15	原子炉建屋	0.940	0.000	⑥	④	原子力発電設備	潤滑油供給ポンプ (344-0340)	0-17-15	原子炉建屋	0.970	0.000	⑥	④	原子力発電設備	燃料送込ポンプ (344-0290)	10F-0	制御ビル	0.440	0.000	⑥	④	原子力発電設備	オイルパン-燃焼ファン (344-42310)	0-17-15	原子炉建屋	0.970	0.000	⑥	④	原子力発電設備	潤滑油供給ポンプ (344-42320)	0-17-15	原子炉建屋	0.140	0.000	⑥	④	原子力発電設備	燃料ディスタンス (344-42320)	0-17-15	原子炉建屋	0.140	0.000	⑥	④	原子力発電設備	潤滑油供給ポンプ (344-92200)	0-17-15	原子炉建屋	0.900	0.000	⑥	④	原子力発電設備	燃料ハンドル停止位置センサー (344-90001)	0-17-15	原子炉建屋	0.970	0.000	⑥	④	原子力発電設備	機器冷却水ポンプ (344-95001)	0-17-15	原子炉建屋	2.400	0.000	⑥	④	原子力発電設備	機器冷却水ポンプ (344-95002)	0-17-15	原子炉建屋	2.400	0.000	⑥	④	原子力発電設備	機器冷却水ポンプ (344-95114)	0-17-15	原子炉建屋	1.800	0.000	⑥	④	原子力発電設備	機器冷却水ポンプ (344-95114-2)	0-17-15	原子炉建屋	1.800	0.000	⑥	④	原子力発電設備	装置冷却水ポンプ (344-95340)	0-17-15	原子炉建屋	0.140	0.000	⑥	④	原子力発電設備	3FC30系-1号機 (344-904300)	0-17-15	原子炉建屋	0.740	0.000	⑥	④	原子力発電設備	3FC30系-2号機 (344-904311)	0-17-15	原子炉建屋	0.740	0.000	⑥	④	原子力発電設備	3FC30系-3号機 (344-904312)	0-17-15	原子炉建屋	0.200	0.000	⑥	④	原子力発電設備	3FC30系-4号機 (344-904313)	0-17-15	原子炉建屋	0.200	0.000	⑥	④	原子力発電設備	機器冷却水ポンプ (344-95001)	0-17-15	原子炉建屋	2.400	0.000	⑥	④	原子力発電設備	潤滑油アミンポンプ (344-92200)	0-17-15	原子炉建屋	1.800	0.000	⑥	④	<p>表1 防護対象設備一覧 (26/35)</p> <table border="1"> <thead> <tr> <th>系統</th> <th>設備</th> <th>区画番号</th> <th>設置建屋</th> <th>基本高さ^{※1}(m)</th> <th>個別測定高さ^{※2}(m)</th> <th>設定箇所</th> <th>安全機能</th> </tr> </thead> <tbody> <tr><td>換気空調系</td><td>B-ディーゼル発電機室内空気温度 (2) (3TS-2750)</td><td>3DG-11-N1</td><td>ディーゼル発電機建屋</td><td>1.67</td><td>5.16</td><td>基本</td><td>⑥</td></tr> <tr><td>換気空調系</td><td>B-ディーゼル発電機室内空気温度 (3) (3TS-2753)</td><td>3DG-11-N1</td><td>ディーゼル発電機建屋</td><td>0.92</td><td>4.41</td><td>基本</td><td>⑥</td></tr> <tr><td>換気空調系</td><td>B-ディーゼル発電機室内空気温度 (4) (3TS-2754)</td><td>3DG-11-N1</td><td>ディーゼル発電機建屋</td><td>0.92</td><td>4.42</td><td>基本</td><td>⑥</td></tr> <tr><td>換気空調系</td><td>A-電動補助給水ポンプ室給気ファン (3VSF40A)</td><td>3RB-11-N6</td><td>原子炉建屋</td><td>4.4</td><td>4.55</td><td>基本</td><td>③</td></tr> <tr><td>換気空調系</td><td>B-電動補助給水ポンプ室給気ファン (3VSF40B)</td><td>3RB-11-N7</td><td>原子炉建屋</td><td>4.4</td><td>4.54</td><td>基本</td><td>③</td></tr> <tr><td>換気空調系</td><td>A-電動補助給水ポンプ室外気取入風量調節ダンパ (3HCD-2670)</td><td>3RB-11-N6</td><td>原子炉建屋</td><td>4.90</td><td>4.53</td><td>個別</td><td>③</td></tr> <tr><td>換気空調系</td><td>B-電動補助給水ポンプ室外気取入風量調節ダンパ (3HCD-2680)</td><td>3RB-11-N7</td><td>原子炉建屋</td><td>4.90</td><td>4.54</td><td>個別</td><td>③</td></tr> <tr><td>換気空調系</td><td>A-電動補助給水ポンプ室外気取入風量調節ダンパ (3HC-2670)</td><td>3RB-11-N6</td><td>原子炉建屋</td><td>5.44</td><td>5.44</td><td>基本</td><td>④</td></tr> <tr><td>換気空調系</td><td>B-電動補助給水ポンプ室外気取入風量調節ダンパ (3HC-2680)</td><td>3RB-11-N7</td><td>原子炉建屋</td><td>5.44</td><td>5.45</td><td>基本</td><td>④</td></tr> <tr><td>換気空調系</td><td>A-電動補助給水ポンプ室内空気温度 (1) (3TS-2671)</td><td>3RB-11-N6</td><td>原子炉建屋</td><td>1.42</td><td>5.39</td><td>基本</td><td>③</td></tr> <tr><td>換気空調系</td><td>A-電動補助給水ポンプ室内空気温度 (2) (3TS-2672)</td><td>3RB-11-N6</td><td>原子炉建屋</td><td>1.42</td><td>5.40</td><td>基本</td><td>③</td></tr> <tr><td>換気空調系</td><td>B-電動補助給水ポンプ室内空気温度 (1) (3TS-2681)</td><td>3RB-11-N7</td><td>原子炉建屋</td><td>1.42</td><td>5.40</td><td>基本</td><td>③</td></tr> </tbody> </table>	系統	設備	区画番号	設置建屋	基本高さ ^{※1} (m)	個別測定高さ ^{※2} (m)	設定箇所	安全機能	換気空調系	B-ディーゼル発電機室内空気温度 (2) (3TS-2750)	3DG-11-N1	ディーゼル発電機建屋	1.67	5.16	基本	⑥	換気空調系	B-ディーゼル発電機室内空気温度 (3) (3TS-2753)	3DG-11-N1	ディーゼル発電機建屋	0.92	4.41	基本	⑥	換気空調系	B-ディーゼル発電機室内空気温度 (4) (3TS-2754)	3DG-11-N1	ディーゼル発電機建屋	0.92	4.42	基本	⑥	換気空調系	A-電動補助給水ポンプ室給気ファン (3VSF40A)	3RB-11-N6	原子炉建屋	4.4	4.55	基本	③	換気空調系	B-電動補助給水ポンプ室給気ファン (3VSF40B)	3RB-11-N7	原子炉建屋	4.4	4.54	基本	③	換気空調系	A-電動補助給水ポンプ室外気取入風量調節ダンパ (3HCD-2670)	3RB-11-N6	原子炉建屋	4.90	4.53	個別	③	換気空調系	B-電動補助給水ポンプ室外気取入風量調節ダンパ (3HCD-2680)	3RB-11-N7	原子炉建屋	4.90	4.54	個別	③	換気空調系	A-電動補助給水ポンプ室外気取入風量調節ダンパ (3HC-2670)	3RB-11-N6	原子炉建屋	5.44	5.44	基本	④	換気空調系	B-電動補助給水ポンプ室外気取入風量調節ダンパ (3HC-2680)	3RB-11-N7	原子炉建屋	5.44	5.45	基本	④	換気空調系	A-電動補助給水ポンプ室内空気温度 (1) (3TS-2671)	3RB-11-N6	原子炉建屋	1.42	5.39	基本	③	換気空調系	A-電動補助給水ポンプ室内空気温度 (2) (3TS-2672)	3RB-11-N6	原子炉建屋	1.42	5.40	基本	③	換気空調系	B-電動補助給水ポンプ室内空気温度 (1) (3TS-2681)	3RB-11-N7	原子炉建屋	1.42	5.40	基本	③	<p>【女川】</p> <p>記載方針の相違 設計方針の相違</p> <p>・泊では評価ガイドの要求に則り、機能喪失高さは、保守的に機能喪失すると仮定した高さである「評価高さ（基本設定箇所）」を標準としているが、評価高さが没水してしまう機器については「実力高さ（個別測定箇所）」を適用している。</p> <p>上記を踏まえ、表1には防護対象設備の「基本設定箇所」と「個別測定箇所」の機能喪失高さを併記し、どちらを採用しているか明確となるよう設定箇所を記載している。（島根2号炉、柏崎6,7号炉と同様）</p> <p>・設備名称等については、炉型の違い及びプラント設計の違いによる相違</p> <p>・安全機能に関しては、炉型の相違により機能名称が異なるが、「止める」「冷やす」「閉じ込める」「ピット冷却」の達成を目的とした機能であることに相違はない。</p>
系統	設備	区画番号	設置建屋	基本高さ ^{※1} (m)	個別測定高さ ^{※2} (m)	設定箇所	安全機能																																																																																																																																																																																																																																																																																																				
原子力発電設備	潤滑油加熱器 (344-3033)	0-17-15	原子炉建屋	0.940	0.000	⑥	④																																																																																																																																																																																																																																																																																																				
原子力発電設備	高圧中心冷却器 (344-0061)	0-17-15	原子炉建屋	1.240	0.000	⑥	④																																																																																																																																																																																																																																																																																																				
原子力発電設備	高圧中心冷却器 (344-0062)	0-17-15	原子炉建屋	0.960	0.000	⑥	④																																																																																																																																																																																																																																																																																																				
原子力発電設備	基本加熱器ポンプ (344-0062)	0-17-15	原子炉建屋	0.900	0.000	⑥	④																																																																																																																																																																																																																																																																																																				
原子力発電設備	潤滑油アミンポンプ (344-0240)	0-17-15	原子炉建屋	0.940	0.000	⑥	④																																																																																																																																																																																																																																																																																																				
原子力発電設備	潤滑油供給ポンプ (344-0340)	0-17-15	原子炉建屋	0.970	0.000	⑥	④																																																																																																																																																																																																																																																																																																				
原子力発電設備	燃料送込ポンプ (344-0290)	10F-0	制御ビル	0.440	0.000	⑥	④																																																																																																																																																																																																																																																																																																				
原子力発電設備	オイルパン-燃焼ファン (344-42310)	0-17-15	原子炉建屋	0.970	0.000	⑥	④																																																																																																																																																																																																																																																																																																				
原子力発電設備	潤滑油供給ポンプ (344-42320)	0-17-15	原子炉建屋	0.140	0.000	⑥	④																																																																																																																																																																																																																																																																																																				
原子力発電設備	燃料ディスタンス (344-42320)	0-17-15	原子炉建屋	0.140	0.000	⑥	④																																																																																																																																																																																																																																																																																																				
原子力発電設備	潤滑油供給ポンプ (344-92200)	0-17-15	原子炉建屋	0.900	0.000	⑥	④																																																																																																																																																																																																																																																																																																				
原子力発電設備	燃料ハンドル停止位置センサー (344-90001)	0-17-15	原子炉建屋	0.970	0.000	⑥	④																																																																																																																																																																																																																																																																																																				
原子力発電設備	機器冷却水ポンプ (344-95001)	0-17-15	原子炉建屋	2.400	0.000	⑥	④																																																																																																																																																																																																																																																																																																				
原子力発電設備	機器冷却水ポンプ (344-95002)	0-17-15	原子炉建屋	2.400	0.000	⑥	④																																																																																																																																																																																																																																																																																																				
原子力発電設備	機器冷却水ポンプ (344-95114)	0-17-15	原子炉建屋	1.800	0.000	⑥	④																																																																																																																																																																																																																																																																																																				
原子力発電設備	機器冷却水ポンプ (344-95114-2)	0-17-15	原子炉建屋	1.800	0.000	⑥	④																																																																																																																																																																																																																																																																																																				
原子力発電設備	装置冷却水ポンプ (344-95340)	0-17-15	原子炉建屋	0.140	0.000	⑥	④																																																																																																																																																																																																																																																																																																				
原子力発電設備	3FC30系-1号機 (344-904300)	0-17-15	原子炉建屋	0.740	0.000	⑥	④																																																																																																																																																																																																																																																																																																				
原子力発電設備	3FC30系-2号機 (344-904311)	0-17-15	原子炉建屋	0.740	0.000	⑥	④																																																																																																																																																																																																																																																																																																				
原子力発電設備	3FC30系-3号機 (344-904312)	0-17-15	原子炉建屋	0.200	0.000	⑥	④																																																																																																																																																																																																																																																																																																				
原子力発電設備	3FC30系-4号機 (344-904313)	0-17-15	原子炉建屋	0.200	0.000	⑥	④																																																																																																																																																																																																																																																																																																				
原子力発電設備	機器冷却水ポンプ (344-95001)	0-17-15	原子炉建屋	2.400	0.000	⑥	④																																																																																																																																																																																																																																																																																																				
原子力発電設備	潤滑油アミンポンプ (344-92200)	0-17-15	原子炉建屋	1.800	0.000	⑥	④																																																																																																																																																																																																																																																																																																				
系統	設備	区画番号	設置建屋	基本高さ ^{※1} (m)	個別測定高さ ^{※2} (m)	設定箇所	安全機能																																																																																																																																																																																																																																																																																																				
換気空調系	B-ディーゼル発電機室内空気温度 (2) (3TS-2750)	3DG-11-N1	ディーゼル発電機建屋	1.67	5.16	基本	⑥																																																																																																																																																																																																																																																																																																				
換気空調系	B-ディーゼル発電機室内空気温度 (3) (3TS-2753)	3DG-11-N1	ディーゼル発電機建屋	0.92	4.41	基本	⑥																																																																																																																																																																																																																																																																																																				
換気空調系	B-ディーゼル発電機室内空気温度 (4) (3TS-2754)	3DG-11-N1	ディーゼル発電機建屋	0.92	4.42	基本	⑥																																																																																																																																																																																																																																																																																																				
換気空調系	A-電動補助給水ポンプ室給気ファン (3VSF40A)	3RB-11-N6	原子炉建屋	4.4	4.55	基本	③																																																																																																																																																																																																																																																																																																				
換気空調系	B-電動補助給水ポンプ室給気ファン (3VSF40B)	3RB-11-N7	原子炉建屋	4.4	4.54	基本	③																																																																																																																																																																																																																																																																																																				
換気空調系	A-電動補助給水ポンプ室外気取入風量調節ダンパ (3HCD-2670)	3RB-11-N6	原子炉建屋	4.90	4.53	個別	③																																																																																																																																																																																																																																																																																																				
換気空調系	B-電動補助給水ポンプ室外気取入風量調節ダンパ (3HCD-2680)	3RB-11-N7	原子炉建屋	4.90	4.54	個別	③																																																																																																																																																																																																																																																																																																				
換気空調系	A-電動補助給水ポンプ室外気取入風量調節ダンパ (3HC-2670)	3RB-11-N6	原子炉建屋	5.44	5.44	基本	④																																																																																																																																																																																																																																																																																																				
換気空調系	B-電動補助給水ポンプ室外気取入風量調節ダンパ (3HC-2680)	3RB-11-N7	原子炉建屋	5.44	5.45	基本	④																																																																																																																																																																																																																																																																																																				
換気空調系	A-電動補助給水ポンプ室内空気温度 (1) (3TS-2671)	3RB-11-N6	原子炉建屋	1.42	5.39	基本	③																																																																																																																																																																																																																																																																																																				
換気空調系	A-電動補助給水ポンプ室内空気温度 (2) (3TS-2672)	3RB-11-N6	原子炉建屋	1.42	5.40	基本	③																																																																																																																																																																																																																																																																																																				
換気空調系	B-電動補助給水ポンプ室内空気温度 (1) (3TS-2681)	3RB-11-N7	原子炉建屋	1.42	5.40	基本	③																																																																																																																																																																																																																																																																																																				
<p>※1：表中に「上」の機能喪失する床面からの高さ（上は高さ0.000mを基準）</p> <p>① 緊急停止機能 ② 緊急停止機能 ③ 緊急停止機能 ④ 緊急停止機能 ⑤ 緊急停止機能 ⑥ 緊急停止機能 ⑦ 緊急停止機能 ⑧ 緊急停止機能 ⑨ 緊急停止機能 ⑩ 緊急停止機能 ⑪ 緊急停止機能 ⑫ 緊急停止機能 ⑬ 緊急停止機能 ⑭ 緊急停止機能 ⑮ 緊急停止機能 ⑯ 緊急停止機能 ⑰ 緊急停止機能 ⑱ 緊急停止機能 ⑲ 緊急停止機能 ⑳ 緊急停止機能 ㉑ 緊急停止機能 ㉒ 緊急停止機能 ㉓ 緊急停止機能 ㉔ 緊急停止機能 ㉕ 緊急停止機能 ㉖ 緊急停止機能 ㉗ 緊急停止機能 ㉘ 緊急停止機能 ㉙ 緊急停止機能 ㉚ 緊急停止機能 ㉛ 緊急停止機能 ㉜ 緊急停止機能 ㉝ 緊急停止機能 ㉞ 緊急停止機能 ㉟ 緊急停止機能 ㊱ 緊急停止機能 ㊲ 緊急停止機能 ㊳ 緊急停止機能 ㊴ 緊急停止機能 ㊵ 緊急停止機能 ㊶ 緊急停止機能 ㊷ 緊急停止機能 ㊸ 緊急停止機能 ㊹ 緊急停止機能 ㊺ 緊急停止機能 ㊻ 緊急停止機能 ㊼ 緊急停止機能 ㊽ 緊急停止機能 ㊾ 緊急停止機能 ㊿ 緊急停止機能</p>		<p>※1：保守的に機能喪失すると仮定した床面からの高さ</p> <p>※2：没水により機能喪失する床面からの高さ</p> <p>① 緊急停止機能 ② 未境界維持機能 ③ 原子炉停止後の除熱機能 ④ 炉心冷却機能 ⑤ 放射性物質の閉じ込め機能 ⑥ 安全上特に重要な関連機能 ⑦ 事故時のプラント状態の把握機能 ⑧ 制御室外からの安全停止機能 ⑨ ピット冷却機能 ⑩ ピット給水機能</p>																																																																																																																																																																																																																																																																																																									

赤字：設備、運用又は体制の相違（設計方針の相違）
 青字：記載箇所又は記載内容の相違（記載方針の相違）
 緑字：記載表現、設備名称の相違（実質的な相違なし）

大阪発電所3/4号炉	女川原子力発電所2号炉	泊発電所3号炉	相違理由																																																																																																																																																																																		
	<p style="text-align: center;">表1 防護対象設備一覧 (27/27)</p> <table border="1" style="width: 100%; border-collapse: collapse;"> <thead> <tr> <th>系統</th> <th>設備</th> <th>区画番号</th> <th>設置階層</th> <th>上L²(m)</th> <th>機能^{※1}</th> </tr> </thead> <tbody> <tr><td>換気空調系</td><td>換気室内空気圧縮機モータ系(31)9号サンプル入り隔離弁</td><td>3-12-9</td><td>原子炉建屋2号棟</td><td>3.244</td><td>⑤</td></tr> <tr><td>換気空調系</td><td>換気室内空気圧縮機モータ系(31)9号サンプル入り隔離弁</td><td>3-12-9</td><td>原子炉建屋2号棟</td><td>3.506</td><td>⑤</td></tr> <tr><td>換気空調系</td><td>換気室内空気圧縮機モータ系(31)9号サンプル入り隔離弁</td><td>3-12-9</td><td>原子炉建屋2号棟</td><td>3.226</td><td>⑤</td></tr> <tr><td>換気空調系</td><td>換気室内空気圧縮機モータ系(31)9号サンプル入り隔離弁</td><td>3-12-9</td><td>原子炉建屋2号棟</td><td>3.494</td><td>⑤</td></tr> <tr><td>換気空調系</td><td>換気室内空気圧縮機モータ系(31)9号サンプル入り隔離弁</td><td>3-12-10</td><td>原子炉建屋2号棟</td><td>3.976</td><td>⑤</td></tr> <tr><td>換気空調系</td><td>換気室内空気圧縮機モータ系(31)9号サンプル入り隔離弁</td><td>3-12-10</td><td>原子炉建屋2号棟</td><td>3.975</td><td>⑤</td></tr> <tr><td>換気空調系</td><td>換気室内空気圧縮機モータ系(30)ファン隔離弁</td><td>3-12-10</td><td>原子炉建屋2号棟</td><td>4.404</td><td>⑤</td></tr> <tr><td>換気空調系</td><td>換気室内空気圧縮機モータ系(32)10号サンプル入り隔離弁</td><td>3-12-10</td><td>原子炉建屋2号棟</td><td>3.971</td><td>⑤</td></tr> <tr><td>換気空調系</td><td>換気室内空気圧縮機モータ系(32)10号サンプル入り隔離弁</td><td>3-12-10</td><td>原子炉建屋2号棟</td><td>3.974</td><td>⑤</td></tr> <tr><td>換気空調系</td><td>換気室内空気圧縮機モータ系(32)ファン隔離弁</td><td>3-12-10</td><td>原子炉建屋2号棟</td><td>4.404</td><td>⑤</td></tr> </tbody> </table> <p style="font-size: small;">※1：図表より機能喪失する床面からの高さ（上L高さ0.955mを考慮） ※2：浸水により機能喪失する床面からの高さ（上L高さ0.955mを考慮） ① 緊急停止機能 ② 緊急停止機能 ③ 緊急停止機能 ④ 緊急停止機能 ⑤ 緊急停止機能 ⑥ 緊急停止機能 ⑦ 緊急停止機能 ⑧ 緊急停止機能 ⑨ 緊急停止機能 ⑩ 緊急停止機能 ⑪ 緊急停止機能 ⑫ 緊急停止機能 ⑬ 緊急停止機能 ⑭ 緊急停止機能 ⑮ 緊急停止機能 ⑯ 緊急停止機能 ⑰ 緊急停止機能 ⑱ 緊急停止機能 ⑲ 緊急停止機能 ⑳ 緊急停止機能 ㉑ 緊急停止機能 ㉒ 緊急停止機能 ㉓ 緊急停止機能 ㉔ 緊急停止機能 ㉕ 緊急停止機能 ㉖ 緊急停止機能 ㉗ 緊急停止機能 ㉘ 緊急停止機能 ㉙ 緊急停止機能 ㉚ 緊急停止機能 ㉛ 緊急停止機能 ㉜ 緊急停止機能 ㉝ 緊急停止機能 ㉞ 緊急停止機能 ㉟ 緊急停止機能 ㊱ 緊急停止機能 ㊲ 緊急停止機能 ㊳ 緊急停止機能 ㊴ 緊急停止機能 ㊵ 緊急停止機能 ㊶ 緊急停止機能 ㊷ 緊急停止機能 ㊸ 緊急停止機能 ㊹ 緊急停止機能 ㊺ 緊急停止機能 ㊻ 緊急停止機能 ㊼ 緊急停止機能 ㊽ 緊急停止機能 ㊾ 緊急停止機能 ㊿ 緊急停止機能</p>	系統	設備	区画番号	設置階層	上L ² (m)	機能 ^{※1}	換気空調系	換気室内空気圧縮機モータ系(31)9号サンプル入り隔離弁	3-12-9	原子炉建屋2号棟	3.244	⑤	換気空調系	換気室内空気圧縮機モータ系(31)9号サンプル入り隔離弁	3-12-9	原子炉建屋2号棟	3.506	⑤	換気空調系	換気室内空気圧縮機モータ系(31)9号サンプル入り隔離弁	3-12-9	原子炉建屋2号棟	3.226	⑤	換気空調系	換気室内空気圧縮機モータ系(31)9号サンプル入り隔離弁	3-12-9	原子炉建屋2号棟	3.494	⑤	換気空調系	換気室内空気圧縮機モータ系(31)9号サンプル入り隔離弁	3-12-10	原子炉建屋2号棟	3.976	⑤	換気空調系	換気室内空気圧縮機モータ系(31)9号サンプル入り隔離弁	3-12-10	原子炉建屋2号棟	3.975	⑤	換気空調系	換気室内空気圧縮機モータ系(30)ファン隔離弁	3-12-10	原子炉建屋2号棟	4.404	⑤	換気空調系	換気室内空気圧縮機モータ系(32)10号サンプル入り隔離弁	3-12-10	原子炉建屋2号棟	3.971	⑤	換気空調系	換気室内空気圧縮機モータ系(32)10号サンプル入り隔離弁	3-12-10	原子炉建屋2号棟	3.974	⑤	換気空調系	換気室内空気圧縮機モータ系(32)ファン隔離弁	3-12-10	原子炉建屋2号棟	4.404	⑤	<p style="text-align: center;">表1 防護対象設備一覧 (27/35)</p> <table border="1" style="width: 100%; border-collapse: collapse;"> <thead> <tr> <th>系統</th> <th>設備</th> <th>区画番号</th> <th>設置階層</th> <th>基本設定高さ^{※1}(m)</th> <th>個別測定高さ^{※2}(m)</th> <th>設定箇所</th> <th>安全機能</th> </tr> </thead> <tbody> <tr><td>換気空調系</td><td>B-電動補助給水ポンプ室内空気温度(2)(3TS-2682)</td><td>3B3-H-N7</td><td>原子炉建屋</td><td>1.42</td><td>5.41</td><td>基本</td><td>⑤</td></tr> <tr><td>換気空調系</td><td>A-新御用空気圧縮機室給気ファン(3VSF42A)</td><td>3B3-H-N2</td><td>原子炉建屋</td><td>4.50</td><td>4.64</td><td>基本</td><td>⑥</td></tr> <tr><td>換気空調系</td><td>B-新御用空気圧縮機室給気ファン(3VSF42B)</td><td>3B3-H-N3</td><td>原子炉建屋</td><td>4.50</td><td>4.64</td><td>基本</td><td>⑥</td></tr> <tr><td>換気空調系</td><td>A-新御用空気圧縮機室外気取入風量調節ダンパ(HICD-2701)</td><td>3B3-H-N2</td><td>原子炉建屋</td><td>5.00</td><td>4.64</td><td>個別</td><td>⑥</td></tr> <tr><td>換気空調系</td><td>B-新御用空気圧縮機室外気取入風量調節ダンパ(HICD-2711)</td><td>3B3-H-N3</td><td>原子炉建屋</td><td>5.00</td><td>4.63</td><td>個別</td><td>⑥</td></tr> <tr><td>換気空調系</td><td>A-新御用空気圧縮機室外気取入風量調節ダンパ流量設定器(3IC-2701)</td><td>3B3-H-N2</td><td>原子炉建屋</td><td>5.74</td><td>5.76</td><td>基本</td><td>⑥</td></tr> <tr><td>換気空調系</td><td>B-新御用空気圧縮機室外気取入風量調節ダンパ流量設定器(3IC-2711)</td><td>3B3-H-N3</td><td>原子炉建屋</td><td>5.74</td><td>5.75</td><td>基本</td><td>⑥</td></tr> <tr><td>換気空調系</td><td>A-新御用空気圧縮機室内空気温度(1)(3TS-2702)</td><td>3B3-H-N2</td><td>原子炉建屋</td><td>1.42</td><td>1.39</td><td>個別</td><td>⑥</td></tr> <tr><td>換気空調系</td><td>A-新御用空気圧縮機室内空気温度(2)(3TS-2703)</td><td>3B3-H-N2</td><td>原子炉建屋</td><td>1.42</td><td>1.39</td><td>個別</td><td>⑥</td></tr> <tr><td>換気空調系</td><td>B-新御用空気圧縮機室内空気温度(1)(3TS-2712)</td><td>3B3-H-N3</td><td>原子炉建屋</td><td>1.42</td><td>1.39</td><td>個別</td><td>⑥</td></tr> <tr><td>換気空調系</td><td>B-新御用空気圧縮機室内空気温度(2)(3TS-2713)</td><td>3B3-H-N3</td><td>原子炉建屋</td><td>1.42</td><td>1.40</td><td>個別</td><td>⑥</td></tr> <tr><td>換気空調系</td><td>A-安全補機開閉器給気ファン(3VSF27A)</td><td>3AB-D-N1</td><td>原子炉補助建屋</td><td>0.15</td><td>2.16</td><td>基本</td><td>⑥</td></tr> <tr><td>換気空調系</td><td>B-安全補機開閉器給気ファン(3VSF27B)</td><td>3AB-D-N1</td><td>原子炉補助建屋</td><td>0.15</td><td>2.16</td><td>基本</td><td>⑥</td></tr> </tbody> </table> <p style="font-size: small;">※1：保守的に機能喪失すると仮定した床面からの高さ ※2：浸水により機能喪失する床面からの高さ ①緊急停止機能 ②未臨界維持機能 ③原子炉停止後の除熱機能 ④炉心冷却機能 ⑤放射性物質の閉じ込め機能 ⑥安全上特に重要な関連機能 ⑦事故時のプラント状態の把握機能 ⑧新御用外からの安全停止機能 ⑨ピット冷却機能 ⑩ピット給水機能</p>	系統	設備	区画番号	設置階層	基本設定高さ ^{※1} (m)	個別測定高さ ^{※2} (m)	設定箇所	安全機能	換気空調系	B-電動補助給水ポンプ室内空気温度(2)(3TS-2682)	3B3-H-N7	原子炉建屋	1.42	5.41	基本	⑤	換気空調系	A-新御用空気圧縮機室給気ファン(3VSF42A)	3B3-H-N2	原子炉建屋	4.50	4.64	基本	⑥	換気空調系	B-新御用空気圧縮機室給気ファン(3VSF42B)	3B3-H-N3	原子炉建屋	4.50	4.64	基本	⑥	換気空調系	A-新御用空気圧縮機室外気取入風量調節ダンパ(HICD-2701)	3B3-H-N2	原子炉建屋	5.00	4.64	個別	⑥	換気空調系	B-新御用空気圧縮機室外気取入風量調節ダンパ(HICD-2711)	3B3-H-N3	原子炉建屋	5.00	4.63	個別	⑥	換気空調系	A-新御用空気圧縮機室外気取入風量調節ダンパ流量設定器(3IC-2701)	3B3-H-N2	原子炉建屋	5.74	5.76	基本	⑥	換気空調系	B-新御用空気圧縮機室外気取入風量調節ダンパ流量設定器(3IC-2711)	3B3-H-N3	原子炉建屋	5.74	5.75	基本	⑥	換気空調系	A-新御用空気圧縮機室内空気温度(1)(3TS-2702)	3B3-H-N2	原子炉建屋	1.42	1.39	個別	⑥	換気空調系	A-新御用空気圧縮機室内空気温度(2)(3TS-2703)	3B3-H-N2	原子炉建屋	1.42	1.39	個別	⑥	換気空調系	B-新御用空気圧縮機室内空気温度(1)(3TS-2712)	3B3-H-N3	原子炉建屋	1.42	1.39	個別	⑥	換気空調系	B-新御用空気圧縮機室内空気温度(2)(3TS-2713)	3B3-H-N3	原子炉建屋	1.42	1.40	個別	⑥	換気空調系	A-安全補機開閉器給気ファン(3VSF27A)	3AB-D-N1	原子炉補助建屋	0.15	2.16	基本	⑥	換気空調系	B-安全補機開閉器給気ファン(3VSF27B)	3AB-D-N1	原子炉補助建屋	0.15	2.16	基本	⑥	<p>【女川】</p> <p>記載方針の相違 設計方針の相違</p> <p>・泊では評価ガイドの要求に則り、機能喪失高さは、保守的に機能喪失すると仮定した高さである「評価高さ（基本設定箇所）」を標準としているが、評価高さで没水してしまう機器については「実力高さ（個別測定箇所）」を適用している。</p> <p>上記を踏まえ、表1には防護対象設備の「基本設定箇所」と「個別測定箇所」の機能喪失高さを併記し、どちらを採用しているか明確となるよう設定箇所を記載している。（島根2号炉、柏崎6,7号炉と同様）</p> <p>・設備名称等については、炉型の違い及びプラント設計の違いによる相違</p> <p>・安全機能に関しては、炉型の相違により機能名称が異なるが、「止める」「冷やす」「閉じ込める」「ピット冷却」の達成を目的とした機能であることに相違はない。</p>
系統	設備	区画番号	設置階層	上L ² (m)	機能 ^{※1}																																																																																																																																																																																
換気空調系	換気室内空気圧縮機モータ系(31)9号サンプル入り隔離弁	3-12-9	原子炉建屋2号棟	3.244	⑤																																																																																																																																																																																
換気空調系	換気室内空気圧縮機モータ系(31)9号サンプル入り隔離弁	3-12-9	原子炉建屋2号棟	3.506	⑤																																																																																																																																																																																
換気空調系	換気室内空気圧縮機モータ系(31)9号サンプル入り隔離弁	3-12-9	原子炉建屋2号棟	3.226	⑤																																																																																																																																																																																
換気空調系	換気室内空気圧縮機モータ系(31)9号サンプル入り隔離弁	3-12-9	原子炉建屋2号棟	3.494	⑤																																																																																																																																																																																
換気空調系	換気室内空気圧縮機モータ系(31)9号サンプル入り隔離弁	3-12-10	原子炉建屋2号棟	3.976	⑤																																																																																																																																																																																
換気空調系	換気室内空気圧縮機モータ系(31)9号サンプル入り隔離弁	3-12-10	原子炉建屋2号棟	3.975	⑤																																																																																																																																																																																
換気空調系	換気室内空気圧縮機モータ系(30)ファン隔離弁	3-12-10	原子炉建屋2号棟	4.404	⑤																																																																																																																																																																																
換気空調系	換気室内空気圧縮機モータ系(32)10号サンプル入り隔離弁	3-12-10	原子炉建屋2号棟	3.971	⑤																																																																																																																																																																																
換気空調系	換気室内空気圧縮機モータ系(32)10号サンプル入り隔離弁	3-12-10	原子炉建屋2号棟	3.974	⑤																																																																																																																																																																																
換気空調系	換気室内空気圧縮機モータ系(32)ファン隔離弁	3-12-10	原子炉建屋2号棟	4.404	⑤																																																																																																																																																																																
系統	設備	区画番号	設置階層	基本設定高さ ^{※1} (m)	個別測定高さ ^{※2} (m)	設定箇所	安全機能																																																																																																																																																																														
換気空調系	B-電動補助給水ポンプ室内空気温度(2)(3TS-2682)	3B3-H-N7	原子炉建屋	1.42	5.41	基本	⑤																																																																																																																																																																														
換気空調系	A-新御用空気圧縮機室給気ファン(3VSF42A)	3B3-H-N2	原子炉建屋	4.50	4.64	基本	⑥																																																																																																																																																																														
換気空調系	B-新御用空気圧縮機室給気ファン(3VSF42B)	3B3-H-N3	原子炉建屋	4.50	4.64	基本	⑥																																																																																																																																																																														
換気空調系	A-新御用空気圧縮機室外気取入風量調節ダンパ(HICD-2701)	3B3-H-N2	原子炉建屋	5.00	4.64	個別	⑥																																																																																																																																																																														
換気空調系	B-新御用空気圧縮機室外気取入風量調節ダンパ(HICD-2711)	3B3-H-N3	原子炉建屋	5.00	4.63	個別	⑥																																																																																																																																																																														
換気空調系	A-新御用空気圧縮機室外気取入風量調節ダンパ流量設定器(3IC-2701)	3B3-H-N2	原子炉建屋	5.74	5.76	基本	⑥																																																																																																																																																																														
換気空調系	B-新御用空気圧縮機室外気取入風量調節ダンパ流量設定器(3IC-2711)	3B3-H-N3	原子炉建屋	5.74	5.75	基本	⑥																																																																																																																																																																														
換気空調系	A-新御用空気圧縮機室内空気温度(1)(3TS-2702)	3B3-H-N2	原子炉建屋	1.42	1.39	個別	⑥																																																																																																																																																																														
換気空調系	A-新御用空気圧縮機室内空気温度(2)(3TS-2703)	3B3-H-N2	原子炉建屋	1.42	1.39	個別	⑥																																																																																																																																																																														
換気空調系	B-新御用空気圧縮機室内空気温度(1)(3TS-2712)	3B3-H-N3	原子炉建屋	1.42	1.39	個別	⑥																																																																																																																																																																														
換気空調系	B-新御用空気圧縮機室内空気温度(2)(3TS-2713)	3B3-H-N3	原子炉建屋	1.42	1.40	個別	⑥																																																																																																																																																																														
換気空調系	A-安全補機開閉器給気ファン(3VSF27A)	3AB-D-N1	原子炉補助建屋	0.15	2.16	基本	⑥																																																																																																																																																																														
換気空調系	B-安全補機開閉器給気ファン(3VSF27B)	3AB-D-N1	原子炉補助建屋	0.15	2.16	基本	⑥																																																																																																																																																																														

赤字：設備、運用又は体制の相違（設計方針の相違）
 青字：記載箇所又は記載内容の相違（記載方針の相違）
 緑字：記載表現、設備名称の相違（実質的な相違なし）

大阪発電所3/4号炉	女川原子力発電所2号炉	泊発電所3号炉	相違理由																																																																																																																
		<p style="text-align: center;">表1 防護対象設備一覧 (28/35)</p> <table border="1" data-bbox="1283 248 1865 837"> <thead> <tr> <th>系統</th> <th>設備</th> <th>区画番号</th> <th>設置建屋</th> <th>基本設定高さ^{※1}(m)</th> <th>個別測定高さ^{※2}(m)</th> <th>設定箇所</th> <th>安全機能</th> </tr> </thead> <tbody> <tr> <td>換気空調系</td> <td>A-安全系計装室室内空気温度 (3TS-2790)</td> <td>3AB-F-N13</td> <td>原子炉補助建屋</td> <td>1.92</td> <td>1.30</td> <td>個別</td> <td>㊸</td> </tr> <tr> <td>換気空調系</td> <td>B-安全系計装室室内空気温度 (3TS-2791)</td> <td>3AB-F-N2</td> <td>原子炉補助建屋</td> <td>1.92</td> <td>1.30</td> <td>個別</td> <td>㊸</td> </tr> <tr> <td>換気空調系</td> <td>A-蓄電池室排気ファン (3VSP1A)</td> <td>3AB-D-N1</td> <td>原子炉補助建屋</td> <td>1.92</td> <td>1.52</td> <td>個別</td> <td>㊸</td> </tr> <tr> <td>換気空調系</td> <td>B-蓄電池室排気ファン (3VSP1B)</td> <td>3AB-D-N1</td> <td>原子炉補助建屋</td> <td>1.92</td> <td>1.51</td> <td>個別</td> <td>㊸</td> </tr> <tr> <td>換気空調系</td> <td>A-中央制御室前扉ファン (3VSP20A)</td> <td>3AB-D-N52</td> <td>原子炉補助建屋</td> <td>0.15</td> <td>0.17</td> <td>基本</td> <td>㊸</td> </tr> <tr> <td>換気空調系</td> <td>B-中央制御室前扉ファン (3VSP20B)</td> <td>3AB-D-N52</td> <td>原子炉補助建屋</td> <td>0.15</td> <td>0.18</td> <td>基本</td> <td>㊸</td> </tr> <tr> <td>換気空調系</td> <td>A-中央制御室給気ファン (3VSP21A)</td> <td>3AB-D-N1</td> <td>原子炉補助建屋</td> <td>0.15</td> <td>1.12</td> <td>基本</td> <td>㊸</td> </tr> <tr> <td>換気空調系</td> <td>B-中央制御室給気ファン (3VSP21B)</td> <td>3AB-D-N1</td> <td>原子炉補助建屋</td> <td>0.15</td> <td>1.13</td> <td>基本</td> <td>㊸</td> </tr> <tr> <td>換気空調系</td> <td>A-中央制御室給気ファン出口ダンパ (3D-VS-603A)</td> <td>3AB-D-N1</td> <td>原子炉補助建屋</td> <td>3.79</td> <td>3.83</td> <td>基本</td> <td>㊸</td> </tr> <tr> <td>換気空調系</td> <td>B-中央制御室給気ファン出口ダンパ (3D-VS-603B)</td> <td>3AB-D-N1</td> <td>原子炉補助建屋</td> <td>3.79</td> <td>3.83</td> <td>基本</td> <td>㊸</td> </tr> <tr> <td>換気空調系</td> <td>A-中央制御室前扉ファン入口ダンパ (3D-VS-604A)</td> <td>3AB-D-N52</td> <td>原子炉補助建屋</td> <td>0.50</td> <td>0.25</td> <td>個別</td> <td>㊸</td> </tr> <tr> <td>換気空調系</td> <td>B-中央制御室前扉ファン入口ダンパ (3D-VS-604B)</td> <td>3AB-D-N52</td> <td>原子炉補助建屋</td> <td>0.50</td> <td>0.26</td> <td>個別</td> <td>㊸</td> </tr> <tr> <td>換気空調系</td> <td>A-中央制御室前扉風量調節ダンパ (3KCD-2836)</td> <td>3AB-D-N52</td> <td>原子炉補助建屋</td> <td>0.50</td> <td>0.25</td> <td>個別</td> <td>㊸</td> </tr> </tbody> </table> <p>※1：保守的に機能喪失すると仮定した床面からの高さ ※2：浸水により機能喪失する床面からの高さ</p> <p>①緊急時停止機能 ②未臨界維持機能 ③原子炉停止後の除熱機能 ④炉心冷却機能 ⑤放射性物質の閉じ込め機能</p> <p>⑥安全上特に重要な関連機能 ⑦事故時のプラント状態の把握機能 ⑧制御室外からの安全停止機能 ⑨ビット冷却機能 ⑩ビット給水機能</p>	系統	設備	区画番号	設置建屋	基本設定高さ ^{※1} (m)	個別測定高さ ^{※2} (m)	設定箇所	安全機能	換気空調系	A-安全系計装室室内空気温度 (3TS-2790)	3AB-F-N13	原子炉補助建屋	1.92	1.30	個別	㊸	換気空調系	B-安全系計装室室内空気温度 (3TS-2791)	3AB-F-N2	原子炉補助建屋	1.92	1.30	個別	㊸	換気空調系	A-蓄電池室排気ファン (3VSP1A)	3AB-D-N1	原子炉補助建屋	1.92	1.52	個別	㊸	換気空調系	B-蓄電池室排気ファン (3VSP1B)	3AB-D-N1	原子炉補助建屋	1.92	1.51	個別	㊸	換気空調系	A-中央制御室前扉ファン (3VSP20A)	3AB-D-N52	原子炉補助建屋	0.15	0.17	基本	㊸	換気空調系	B-中央制御室前扉ファン (3VSP20B)	3AB-D-N52	原子炉補助建屋	0.15	0.18	基本	㊸	換気空調系	A-中央制御室給気ファン (3VSP21A)	3AB-D-N1	原子炉補助建屋	0.15	1.12	基本	㊸	換気空調系	B-中央制御室給気ファン (3VSP21B)	3AB-D-N1	原子炉補助建屋	0.15	1.13	基本	㊸	換気空調系	A-中央制御室給気ファン出口ダンパ (3D-VS-603A)	3AB-D-N1	原子炉補助建屋	3.79	3.83	基本	㊸	換気空調系	B-中央制御室給気ファン出口ダンパ (3D-VS-603B)	3AB-D-N1	原子炉補助建屋	3.79	3.83	基本	㊸	換気空調系	A-中央制御室前扉ファン入口ダンパ (3D-VS-604A)	3AB-D-N52	原子炉補助建屋	0.50	0.25	個別	㊸	換気空調系	B-中央制御室前扉ファン入口ダンパ (3D-VS-604B)	3AB-D-N52	原子炉補助建屋	0.50	0.26	個別	㊸	換気空調系	A-中央制御室前扉風量調節ダンパ (3KCD-2836)	3AB-D-N52	原子炉補助建屋	0.50	0.25	個別	㊸	<p>【女川】</p> <p>記載方針の相違</p> <p>設計方針の相違</p> <p>・泊では評価ガイドの要求に則り、機能喪失高さは、保守的に機能喪失すると仮定した高さである「評価高さ（基本設定箇所）」を標準としているが、評価高さで没水してしまう機器については「実力高さ（個別測定箇所）」を適用している。</p> <p>上記を踏まえ、表1には防護対象設備の「基本設定箇所」と「個別測定箇所」の機能喪失高さを併記し、どちらを採用しているか明確となるよう設定箇所を記載している。（島根2号炉、柏崎6,7号炉と同様）</p> <p>・炉型の違い及びプラント設計の違いによる相違</p> <p>・安全機能に関して、炉型の相違により機能名称が異なるが、「止める」「冷やす」「閉じ込める」「ビット冷却」の達成を目的とした機能であることに相違はない。</p>
系統	設備	区画番号	設置建屋	基本設定高さ ^{※1} (m)	個別測定高さ ^{※2} (m)	設定箇所	安全機能																																																																																																												
換気空調系	A-安全系計装室室内空気温度 (3TS-2790)	3AB-F-N13	原子炉補助建屋	1.92	1.30	個別	㊸																																																																																																												
換気空調系	B-安全系計装室室内空気温度 (3TS-2791)	3AB-F-N2	原子炉補助建屋	1.92	1.30	個別	㊸																																																																																																												
換気空調系	A-蓄電池室排気ファン (3VSP1A)	3AB-D-N1	原子炉補助建屋	1.92	1.52	個別	㊸																																																																																																												
換気空調系	B-蓄電池室排気ファン (3VSP1B)	3AB-D-N1	原子炉補助建屋	1.92	1.51	個別	㊸																																																																																																												
換気空調系	A-中央制御室前扉ファン (3VSP20A)	3AB-D-N52	原子炉補助建屋	0.15	0.17	基本	㊸																																																																																																												
換気空調系	B-中央制御室前扉ファン (3VSP20B)	3AB-D-N52	原子炉補助建屋	0.15	0.18	基本	㊸																																																																																																												
換気空調系	A-中央制御室給気ファン (3VSP21A)	3AB-D-N1	原子炉補助建屋	0.15	1.12	基本	㊸																																																																																																												
換気空調系	B-中央制御室給気ファン (3VSP21B)	3AB-D-N1	原子炉補助建屋	0.15	1.13	基本	㊸																																																																																																												
換気空調系	A-中央制御室給気ファン出口ダンパ (3D-VS-603A)	3AB-D-N1	原子炉補助建屋	3.79	3.83	基本	㊸																																																																																																												
換気空調系	B-中央制御室給気ファン出口ダンパ (3D-VS-603B)	3AB-D-N1	原子炉補助建屋	3.79	3.83	基本	㊸																																																																																																												
換気空調系	A-中央制御室前扉ファン入口ダンパ (3D-VS-604A)	3AB-D-N52	原子炉補助建屋	0.50	0.25	個別	㊸																																																																																																												
換気空調系	B-中央制御室前扉ファン入口ダンパ (3D-VS-604B)	3AB-D-N52	原子炉補助建屋	0.50	0.26	個別	㊸																																																																																																												
換気空調系	A-中央制御室前扉風量調節ダンパ (3KCD-2836)	3AB-D-N52	原子炉補助建屋	0.50	0.25	個別	㊸																																																																																																												

赤字：設備、運用又は体制の相違（設計方針の相違）
 青字：記載箇所又は記載内容の相違（記載方針の相違）
 緑字：記載表現、設備名称の相違（実質的な相違なし）

大阪発電所3/4号炉	女川原子力発電所2号炉	泊発電所3号炉	相違理由																																																																																																								
		<p style="text-align: center;">表1 防護対象設備一覧 (29/35)</p> <table border="1" data-bbox="1285 245 1856 874"> <thead> <tr> <th>系統</th> <th>設備</th> <th>区画番号</th> <th>設置建屋</th> <th>基本設定高さ^{※1}(m)</th> <th>個別測定高さ^{※2}(m)</th> <th>設定箇所</th> <th>安全機能</th> </tr> </thead> <tbody> <tr> <td>換気空調系</td> <td>B-中央制御室前帯風量調節ダンパ (3BCD-2837)</td> <td>3AB-D-N5C</td> <td>原子炉補助建屋</td> <td>0.80</td> <td>0.25</td> <td>個別</td> <td>㊸</td> </tr> <tr> <td>換気空調系</td> <td>A-中央制御室前帯風量調節ダンパ流量設定器 (3BC-2936)</td> <td>3AB-D-N1</td> <td>原子炉補助建屋</td> <td>1.14</td> <td>1.15</td> <td>基本</td> <td>㊸</td> </tr> <tr> <td>換気空調系</td> <td>B-中央制御室前帯風量調節ダンパ流量設定器 (3BC-2837)</td> <td>3AB-D-N1</td> <td>原子炉補助建屋</td> <td>1.14</td> <td>1.15</td> <td>基本</td> <td>㊸</td> </tr> <tr> <td>換気空調系</td> <td>中央制御室内空気温度 (2) (3TS-2846)</td> <td>3AB-F-N8</td> <td>原子炉補助建屋</td> <td>1.92</td> <td>1.30</td> <td>個別</td> <td>㊸</td> </tr> <tr> <td>換気空調系</td> <td>中央制御室内空気温度 (3) (3TS-2847)</td> <td>3AB-F-N8</td> <td>原子炉補助建屋</td> <td>1.92</td> <td>1.30</td> <td>個別</td> <td>㊸</td> </tr> <tr> <td>換気空調系</td> <td>A-中央制御室非常用循環ファン (3VSF22A)</td> <td>3AB-D-N1</td> <td>原子炉補助建屋</td> <td>0.15</td> <td>0.54</td> <td>基本</td> <td>㊸</td> </tr> <tr> <td>換気空調系</td> <td>B-中央制御室非常用循環ファン (3VSF22B)</td> <td>3AB-D-N1</td> <td>原子炉補助建屋</td> <td>0.15</td> <td>0.54</td> <td>基本</td> <td>㊸</td> </tr> <tr> <td>換気空調系</td> <td>A-中央制御室非常用循環ファン出口空気流量 (3FS-2867)</td> <td>3AB-D-N1</td> <td>原子炉補助建屋</td> <td>1.35</td> <td>1.34</td> <td>個別</td> <td>㊸</td> </tr> <tr> <td>換気空調系</td> <td>B-中央制御室非常用循環ファン出口空気流量 (3FS-2868)</td> <td>3AB-D-N1</td> <td>原子炉補助建屋</td> <td>1.35</td> <td>1.34</td> <td>個別</td> <td>㊸</td> </tr> <tr> <td>換気空調系</td> <td>A-中央制御室非常用循環ファン入口ダンパ (3D-YS-602A)</td> <td>3AB-D-N1</td> <td>原子炉補助建屋</td> <td>0.70</td> <td>0.36</td> <td>個別</td> <td>㊸</td> </tr> <tr> <td>換気空調系</td> <td>B-中央制御室非常用循環ファン入口ダンパ (3D-YS-602B)</td> <td>3AB-D-N1</td> <td>原子炉補助建屋</td> <td>0.70</td> <td>0.36</td> <td>個別</td> <td>㊸</td> </tr> <tr> <td>換気空調系</td> <td>A-中央制御室外気取入風量調節ダンパ (3BCD-2825)</td> <td>3AB-D-N1</td> <td>原子炉補助建屋</td> <td>5.34</td> <td>5.31</td> <td>個別</td> <td>㊸</td> </tr> </tbody> </table> <p>※1：保守的に機能喪失すると仮定した床面からの高さ ※2：浸水により機能喪失する床面からの高さ</p> <p>①緊急時停止機能 ②未臨界維持機能 ③原子炉停止後の除熱機能 ④炉心冷却機能 ⑤放射性物質の閉じ込め機能</p> <p>㊸安全上特に重要な関連機能 ㊹事故時のプラント状態の把握機能 ㊺制御室外からの安全停止機能 ㊻ピット冷却機能 ㊼ピット給水機能</p>	系統	設備	区画番号	設置建屋	基本設定高さ ^{※1} (m)	個別測定高さ ^{※2} (m)	設定箇所	安全機能	換気空調系	B-中央制御室前帯風量調節ダンパ (3BCD-2837)	3AB-D-N5C	原子炉補助建屋	0.80	0.25	個別	㊸	換気空調系	A-中央制御室前帯風量調節ダンパ流量設定器 (3BC-2936)	3AB-D-N1	原子炉補助建屋	1.14	1.15	基本	㊸	換気空調系	B-中央制御室前帯風量調節ダンパ流量設定器 (3BC-2837)	3AB-D-N1	原子炉補助建屋	1.14	1.15	基本	㊸	換気空調系	中央制御室内空気温度 (2) (3TS-2846)	3AB-F-N8	原子炉補助建屋	1.92	1.30	個別	㊸	換気空調系	中央制御室内空気温度 (3) (3TS-2847)	3AB-F-N8	原子炉補助建屋	1.92	1.30	個別	㊸	換気空調系	A-中央制御室非常用循環ファン (3VSF22A)	3AB-D-N1	原子炉補助建屋	0.15	0.54	基本	㊸	換気空調系	B-中央制御室非常用循環ファン (3VSF22B)	3AB-D-N1	原子炉補助建屋	0.15	0.54	基本	㊸	換気空調系	A-中央制御室非常用循環ファン出口空気流量 (3FS-2867)	3AB-D-N1	原子炉補助建屋	1.35	1.34	個別	㊸	換気空調系	B-中央制御室非常用循環ファン出口空気流量 (3FS-2868)	3AB-D-N1	原子炉補助建屋	1.35	1.34	個別	㊸	換気空調系	A-中央制御室非常用循環ファン入口ダンパ (3D-YS-602A)	3AB-D-N1	原子炉補助建屋	0.70	0.36	個別	㊸	換気空調系	B-中央制御室非常用循環ファン入口ダンパ (3D-YS-602B)	3AB-D-N1	原子炉補助建屋	0.70	0.36	個別	㊸	換気空調系	A-中央制御室外気取入風量調節ダンパ (3BCD-2825)	3AB-D-N1	原子炉補助建屋	5.34	5.31	個別	㊸	<p>【女川】</p> <p>記載方針の相違</p> <p>設計方針の相違</p> <p>・泊では評価ガイドの要求に則り、機能喪失高さは、保守的に機能喪失すると仮定した高さである「評価高さ（基本設定箇所）」を標準としているが、評価高さで没水してしまう機器については「実力高さ（個別測定箇所）」を適用している。</p> <p>上記を踏まえ、表1には防護対象設備の「基本設定箇所」と「個別測定箇所」の機能喪失高さを併記し、どちらを採用しているか明確となるよう設定箇所を記載している。（島根2号炉、柏崎6.7号炉と同様）</p> <p>・設備名称等については、炉型の違い及びプラント設計の違いによる相違</p> <p>・安全機能に関して、炉型の相違により機能名称が異なるが、「止める」「冷やす」「閉じ込める」「ピット冷却」の達成を目的とした機能であることに相違はない。</p>
系統	設備	区画番号	設置建屋	基本設定高さ ^{※1} (m)	個別測定高さ ^{※2} (m)	設定箇所	安全機能																																																																																																				
換気空調系	B-中央制御室前帯風量調節ダンパ (3BCD-2837)	3AB-D-N5C	原子炉補助建屋	0.80	0.25	個別	㊸																																																																																																				
換気空調系	A-中央制御室前帯風量調節ダンパ流量設定器 (3BC-2936)	3AB-D-N1	原子炉補助建屋	1.14	1.15	基本	㊸																																																																																																				
換気空調系	B-中央制御室前帯風量調節ダンパ流量設定器 (3BC-2837)	3AB-D-N1	原子炉補助建屋	1.14	1.15	基本	㊸																																																																																																				
換気空調系	中央制御室内空気温度 (2) (3TS-2846)	3AB-F-N8	原子炉補助建屋	1.92	1.30	個別	㊸																																																																																																				
換気空調系	中央制御室内空気温度 (3) (3TS-2847)	3AB-F-N8	原子炉補助建屋	1.92	1.30	個別	㊸																																																																																																				
換気空調系	A-中央制御室非常用循環ファン (3VSF22A)	3AB-D-N1	原子炉補助建屋	0.15	0.54	基本	㊸																																																																																																				
換気空調系	B-中央制御室非常用循環ファン (3VSF22B)	3AB-D-N1	原子炉補助建屋	0.15	0.54	基本	㊸																																																																																																				
換気空調系	A-中央制御室非常用循環ファン出口空気流量 (3FS-2867)	3AB-D-N1	原子炉補助建屋	1.35	1.34	個別	㊸																																																																																																				
換気空調系	B-中央制御室非常用循環ファン出口空気流量 (3FS-2868)	3AB-D-N1	原子炉補助建屋	1.35	1.34	個別	㊸																																																																																																				
換気空調系	A-中央制御室非常用循環ファン入口ダンパ (3D-YS-602A)	3AB-D-N1	原子炉補助建屋	0.70	0.36	個別	㊸																																																																																																				
換気空調系	B-中央制御室非常用循環ファン入口ダンパ (3D-YS-602B)	3AB-D-N1	原子炉補助建屋	0.70	0.36	個別	㊸																																																																																																				
換気空調系	A-中央制御室外気取入風量調節ダンパ (3BCD-2825)	3AB-D-N1	原子炉補助建屋	5.34	5.31	個別	㊸																																																																																																				

赤字：設備、運用又は体制の相違（設計方針の相違）
 青字：記載箇所又は記載内容の相違（記載方針の相違）
 緑字：記載表現、設備名称の相違（実質的な相違なし）

大阪発電所3/4号炉	女川原子力発電所2号炉	泊発電所3号炉	相違理由																																																																																																																		
		<p style="text-align: center;">表1 防護対象設備一覧 (30/35)</p> <table border="1" style="width: 100%; border-collapse: collapse;"> <thead> <tr> <th>系統</th> <th>設備</th> <th>区画番号</th> <th>設置建屋</th> <th>基本設定高さ^{※1}(m)</th> <th>個別測定高さ^{※2}(m)</th> <th>設定箇所</th> <th>安全機能</th> </tr> </thead> <tbody> <tr> <td>換気空調系</td> <td>B-中央制御室外気取入風量調節ダンパ (3HC-2824)</td> <td>3AB-D-N1</td> <td>原子炉補助建屋</td> <td>5.34</td> <td>5.31</td> <td>個別</td> <td>㊸</td> </tr> <tr> <td>換気空調系</td> <td>A-中央制御室外気取入風量調節ダンパ流量設定器 (3HC-2823)</td> <td>3AB-D-N1</td> <td>原子炉補助建屋</td> <td>1.64</td> <td>1.65</td> <td>基本</td> <td>㊹</td> </tr> <tr> <td>換気空調系</td> <td>B-中央制御室外気取入風量調節ダンパ流量設定器 (3HC-2824)</td> <td>3AB-D-N1</td> <td>原子炉補助建屋</td> <td>1.64</td> <td>1.65</td> <td>基本</td> <td>㊹</td> </tr> <tr> <td>換気空調系</td> <td>A-中央制御室事故時外気取入風量調節ダンパ (3HC-2850)</td> <td>3AB-D-N1</td> <td>原子炉補助建屋</td> <td>4.94</td> <td>4.62</td> <td>個別</td> <td>㊸</td> </tr> <tr> <td>換気空調系</td> <td>B-中央制御室事故時外気取入風量調節ダンパ (3HC-2851)</td> <td>3AB-D-N1</td> <td>原子炉補助建屋</td> <td>4.94</td> <td>5.00</td> <td>基本</td> <td>㊹</td> </tr> <tr> <td>換気空調系</td> <td>A-中央制御室事故時外気取入風量調節ダンパ流量設定器 (3HC-2850)</td> <td>3AB-D-N1</td> <td>原子炉補助建屋</td> <td>1.14</td> <td>1.15</td> <td>基本</td> <td>㊹</td> </tr> <tr> <td>換気空調系</td> <td>B-中央制御室事故時外気取入風量調節ダンパ流量設定器 (3HC-2851)</td> <td>3AB-D-N1</td> <td>原子炉補助建屋</td> <td>1.14</td> <td>1.15</td> <td>基本</td> <td>㊹</td> </tr> <tr> <td>換気空調系</td> <td>試料採取室排気隔離ダンパ (3D-VS-653)</td> <td>3AB-B-1</td> <td>原子炉補助建屋</td> <td>4.15</td> <td>3.29</td> <td>個別</td> <td>㊸</td> </tr> <tr> <td>換気空調系</td> <td>試料採取室排気風量制御ダンパ (3FCD-2905)</td> <td>3AB-B-1</td> <td>原子炉補助建屋</td> <td>4.15</td> <td>3.61</td> <td>個別</td> <td>㊸</td> </tr> <tr> <td>換気空調系</td> <td>A-原子炉補機冷却水サーージタンク室電気ヒータ (3VSE3A)</td> <td>3IB-A-N2</td> <td>原子炉建屋</td> <td>2.50</td> <td>2.49</td> <td>個別</td> <td>㊸</td> </tr> <tr> <td>換気空調系</td> <td>B-原子炉補機冷却水サーージタンク室電気ヒータ (3VSE3B)</td> <td>3IB-A-N2</td> <td>原子炉建屋</td> <td>2.50</td> <td>2.49</td> <td>個別</td> <td>㊸</td> </tr> <tr> <td>換気空調系</td> <td>A-非管理区域空調機器室電気ヒータ (3VSE2A)</td> <td>3AB-D-N1</td> <td>原子炉補助建屋</td> <td>2.50</td> <td>2.53</td> <td>基本</td> <td>㊹</td> </tr> </tbody> </table> <p>※1：保守的に機能喪失すると仮定した床面からの高さ ※2：設水により機能喪失する床面からの高さ</p> <table style="width: 100%; font-size: small;"> <tr> <td>①緊急時停止機能</td> <td>⑥安全上特に重要な関連機能</td> </tr> <tr> <td>②未臨界維持機能</td> <td>⑦事故時のプラント状態の把握機能</td> </tr> <tr> <td>③原子炉停止後の除熱機能</td> <td>⑧制御室外からの安全停止機能</td> </tr> <tr> <td>④炉心冷却機能</td> <td>⑨ピット冷却機能</td> </tr> <tr> <td>⑤放射性物質の閉じ込め機能</td> <td>⑩ピット給水機能</td> </tr> </table>	系統	設備	区画番号	設置建屋	基本設定高さ ^{※1} (m)	個別測定高さ ^{※2} (m)	設定箇所	安全機能	換気空調系	B-中央制御室外気取入風量調節ダンパ (3HC-2824)	3AB-D-N1	原子炉補助建屋	5.34	5.31	個別	㊸	換気空調系	A-中央制御室外気取入風量調節ダンパ流量設定器 (3HC-2823)	3AB-D-N1	原子炉補助建屋	1.64	1.65	基本	㊹	換気空調系	B-中央制御室外気取入風量調節ダンパ流量設定器 (3HC-2824)	3AB-D-N1	原子炉補助建屋	1.64	1.65	基本	㊹	換気空調系	A-中央制御室事故時外気取入風量調節ダンパ (3HC-2850)	3AB-D-N1	原子炉補助建屋	4.94	4.62	個別	㊸	換気空調系	B-中央制御室事故時外気取入風量調節ダンパ (3HC-2851)	3AB-D-N1	原子炉補助建屋	4.94	5.00	基本	㊹	換気空調系	A-中央制御室事故時外気取入風量調節ダンパ流量設定器 (3HC-2850)	3AB-D-N1	原子炉補助建屋	1.14	1.15	基本	㊹	換気空調系	B-中央制御室事故時外気取入風量調節ダンパ流量設定器 (3HC-2851)	3AB-D-N1	原子炉補助建屋	1.14	1.15	基本	㊹	換気空調系	試料採取室排気隔離ダンパ (3D-VS-653)	3AB-B-1	原子炉補助建屋	4.15	3.29	個別	㊸	換気空調系	試料採取室排気風量制御ダンパ (3FCD-2905)	3AB-B-1	原子炉補助建屋	4.15	3.61	個別	㊸	換気空調系	A-原子炉補機冷却水サーージタンク室電気ヒータ (3VSE3A)	3IB-A-N2	原子炉建屋	2.50	2.49	個別	㊸	換気空調系	B-原子炉補機冷却水サーージタンク室電気ヒータ (3VSE3B)	3IB-A-N2	原子炉建屋	2.50	2.49	個別	㊸	換気空調系	A-非管理区域空調機器室電気ヒータ (3VSE2A)	3AB-D-N1	原子炉補助建屋	2.50	2.53	基本	㊹	①緊急時停止機能	⑥安全上特に重要な関連機能	②未臨界維持機能	⑦事故時のプラント状態の把握機能	③原子炉停止後の除熱機能	⑧制御室外からの安全停止機能	④炉心冷却機能	⑨ピット冷却機能	⑤放射性物質の閉じ込め機能	⑩ピット給水機能	<p>【女川】 記載方針の相違 設計方針の相違</p> <p>・泊では評価ガイドの要求に則り、機能喪失高さは、保守的に機能喪失すると仮定した高さである「評価高さ（基本設定箇所）」を標準としているが、評価高さが没水してしまう機器については「実力高さ（個別測定箇所）」を適用している。</p> <p>上記を踏まえ、表1には防護対象設備の「基本設定箇所」と「個別測定箇所」の機能喪失高さを併記し、どちらを採用しているか明確となるよう設定箇所を記載している。（島根2号炉、柏崎6.7号炉と同様）</p> <p>・設備名称等については、炉型の違い及びプラント設計の違いによる相違</p> <p>・安全機能に関して、炉型の相違により機能名称が異なるが、「止める」「冷やす」「閉じ込める」「ピット冷却」の達成を目的とした機能であることに相違はない。</p>
系統	設備	区画番号	設置建屋	基本設定高さ ^{※1} (m)	個別測定高さ ^{※2} (m)	設定箇所	安全機能																																																																																																														
換気空調系	B-中央制御室外気取入風量調節ダンパ (3HC-2824)	3AB-D-N1	原子炉補助建屋	5.34	5.31	個別	㊸																																																																																																														
換気空調系	A-中央制御室外気取入風量調節ダンパ流量設定器 (3HC-2823)	3AB-D-N1	原子炉補助建屋	1.64	1.65	基本	㊹																																																																																																														
換気空調系	B-中央制御室外気取入風量調節ダンパ流量設定器 (3HC-2824)	3AB-D-N1	原子炉補助建屋	1.64	1.65	基本	㊹																																																																																																														
換気空調系	A-中央制御室事故時外気取入風量調節ダンパ (3HC-2850)	3AB-D-N1	原子炉補助建屋	4.94	4.62	個別	㊸																																																																																																														
換気空調系	B-中央制御室事故時外気取入風量調節ダンパ (3HC-2851)	3AB-D-N1	原子炉補助建屋	4.94	5.00	基本	㊹																																																																																																														
換気空調系	A-中央制御室事故時外気取入風量調節ダンパ流量設定器 (3HC-2850)	3AB-D-N1	原子炉補助建屋	1.14	1.15	基本	㊹																																																																																																														
換気空調系	B-中央制御室事故時外気取入風量調節ダンパ流量設定器 (3HC-2851)	3AB-D-N1	原子炉補助建屋	1.14	1.15	基本	㊹																																																																																																														
換気空調系	試料採取室排気隔離ダンパ (3D-VS-653)	3AB-B-1	原子炉補助建屋	4.15	3.29	個別	㊸																																																																																																														
換気空調系	試料採取室排気風量制御ダンパ (3FCD-2905)	3AB-B-1	原子炉補助建屋	4.15	3.61	個別	㊸																																																																																																														
換気空調系	A-原子炉補機冷却水サーージタンク室電気ヒータ (3VSE3A)	3IB-A-N2	原子炉建屋	2.50	2.49	個別	㊸																																																																																																														
換気空調系	B-原子炉補機冷却水サーージタンク室電気ヒータ (3VSE3B)	3IB-A-N2	原子炉建屋	2.50	2.49	個別	㊸																																																																																																														
換気空調系	A-非管理区域空調機器室電気ヒータ (3VSE2A)	3AB-D-N1	原子炉補助建屋	2.50	2.53	基本	㊹																																																																																																														
①緊急時停止機能	⑥安全上特に重要な関連機能																																																																																																																				
②未臨界維持機能	⑦事故時のプラント状態の把握機能																																																																																																																				
③原子炉停止後の除熱機能	⑧制御室外からの安全停止機能																																																																																																																				
④炉心冷却機能	⑨ピット冷却機能																																																																																																																				
⑤放射性物質の閉じ込め機能	⑩ピット給水機能																																																																																																																				

赤字：設備、運用又は体制の相違（設計方針の相違）
 青字：記載箇所又は記載内容の相違（記載方針の相違）
 緑字：記載表現、設備名称の相違（実質的な相違なし）

大阪発電所3/4号炉	女川原子力発電所2号炉	泊発電所3号炉	相違理由																																																																																										
		<p style="text-align: center;">表1 防護対象設備一覧 (31/35)</p> <table border="1" data-bbox="1285 245 1856 746"> <thead> <tr> <th>系統</th> <th>設備</th> <th>区画番号</th> <th>設置建屋</th> <th>基本設定高さ^{※1}(m)</th> <th>個別測定高さ^{※2}(m)</th> <th>設定箇所</th> <th>安全機能</th> </tr> </thead> <tbody> <tr> <td>換気空調系</td> <td>B-非管理区域空調機器室電気ヒータ (3VSE2B)</td> <td>3AB-D-N1</td> <td>原子炉補助建屋</td> <td>2.57</td> <td>2.58</td> <td>基本</td> <td>㊦</td> </tr> <tr> <td>換気空調系</td> <td>C-非管理区域空調機器室電気ヒータ (3VSE2C)</td> <td>3AB-D-N1</td> <td>原子炉補助建屋</td> <td>2.50</td> <td>2.51</td> <td>基本</td> <td>㊦</td> </tr> <tr> <td>換気空調系</td> <td>D-非管理区域空調機器室電気ヒータ (3VSE2D)</td> <td>3AB-D-N1</td> <td>原子炉補助建屋</td> <td>2.57</td> <td>2.58</td> <td>基本</td> <td>㊦</td> </tr> <tr> <td>換気空調系</td> <td>A-制御用空気圧縮機室電気ヒータ (3VSE1A)</td> <td>3RB-H-N2</td> <td>原子炉建屋</td> <td>2.80</td> <td>2.80</td> <td>基本</td> <td>㊦</td> </tr> <tr> <td>換気空調系</td> <td>B-制御用空気圧縮機室電気ヒータ (3VSE1B)</td> <td>3RB-H-N3</td> <td>原子炉建屋</td> <td>2.80</td> <td>2.79</td> <td>個別</td> <td>㊦</td> </tr> <tr> <td>換気空調系</td> <td>A-原子炉補機冷却水サージタンク室室内空気温度(1) (3TS-2970)</td> <td>3RB-A-N2</td> <td>原子炉建屋</td> <td>1.42</td> <td>1.42</td> <td>基本</td> <td>㊦</td> </tr> <tr> <td>換気空調系</td> <td>A-原子炉補機冷却水サージタンク室室内空気温度(2) (3TS-2971)</td> <td>3RB-A-N2</td> <td>原子炉建屋</td> <td>1.42</td> <td>1.42</td> <td>基本</td> <td>㊦</td> </tr> <tr> <td>換気空調系</td> <td>B-原子炉補機冷却水サージタンク室室内空気温度(1) (3TS-2980)</td> <td>3RB-A-N2</td> <td>原子炉建屋</td> <td>1.42</td> <td>1.41</td> <td>個別</td> <td>㊦</td> </tr> <tr> <td>換気空調系</td> <td>B-原子炉補機冷却水サージタンク室室内空気温度(2) (3TS-2981)</td> <td>3RB-A-N2</td> <td>原子炉建屋</td> <td>1.42</td> <td>1.41</td> <td>個別</td> <td>㊦</td> </tr> </tbody> </table> <p>※1：保守的に機能喪失すると仮定した床面からの高さ ※2：浸水により機能喪失する床面からの高さ</p> <table border="0" data-bbox="1308 788 1760 855"> <tr> <td>①緊急時停止機能</td> <td>⑥安全上時に重要な関連機能</td> </tr> <tr> <td>②未臨界維持機能</td> <td>⑦事故時のプラント状態の把握機能</td> </tr> <tr> <td>③原子炉停止後の除熱機能</td> <td>⑧制御室外からの安全停止機能</td> </tr> <tr> <td>④炉心冷却機能</td> <td>⑨ピット冷却機能</td> </tr> <tr> <td>⑤放射性物質の閉じ込め機能</td> <td>⑩ピット給水機能</td> </tr> </table>	系統	設備	区画番号	設置建屋	基本設定高さ ^{※1} (m)	個別測定高さ ^{※2} (m)	設定箇所	安全機能	換気空調系	B-非管理区域空調機器室電気ヒータ (3VSE2B)	3AB-D-N1	原子炉補助建屋	2.57	2.58	基本	㊦	換気空調系	C-非管理区域空調機器室電気ヒータ (3VSE2C)	3AB-D-N1	原子炉補助建屋	2.50	2.51	基本	㊦	換気空調系	D-非管理区域空調機器室電気ヒータ (3VSE2D)	3AB-D-N1	原子炉補助建屋	2.57	2.58	基本	㊦	換気空調系	A-制御用空気圧縮機室電気ヒータ (3VSE1A)	3RB-H-N2	原子炉建屋	2.80	2.80	基本	㊦	換気空調系	B-制御用空気圧縮機室電気ヒータ (3VSE1B)	3RB-H-N3	原子炉建屋	2.80	2.79	個別	㊦	換気空調系	A-原子炉補機冷却水サージタンク室室内空気温度(1) (3TS-2970)	3RB-A-N2	原子炉建屋	1.42	1.42	基本	㊦	換気空調系	A-原子炉補機冷却水サージタンク室室内空気温度(2) (3TS-2971)	3RB-A-N2	原子炉建屋	1.42	1.42	基本	㊦	換気空調系	B-原子炉補機冷却水サージタンク室室内空気温度(1) (3TS-2980)	3RB-A-N2	原子炉建屋	1.42	1.41	個別	㊦	換気空調系	B-原子炉補機冷却水サージタンク室室内空気温度(2) (3TS-2981)	3RB-A-N2	原子炉建屋	1.42	1.41	個別	㊦	①緊急時停止機能	⑥安全上時に重要な関連機能	②未臨界維持機能	⑦事故時のプラント状態の把握機能	③原子炉停止後の除熱機能	⑧制御室外からの安全停止機能	④炉心冷却機能	⑨ピット冷却機能	⑤放射性物質の閉じ込め機能	⑩ピット給水機能	<p>【女川】</p> <p>記載方針の相違</p> <p>設計方針の相違</p> <ul style="list-style-type: none"> ・泊では評価ガイドの要求に則り、機能喪失高さは、保守的に機能喪失すると仮定した高さである「評価高さ（基本設定箇所）」を標準としているが、評価高さで没水してしまう機器については「実力高さ（個別測定箇所）」を適用している。 上記を踏まえ、表1には防護対象設備の「基本設定箇所」と「個別測定箇所」の機能喪失高さを併記し、どちらを採用しているか明確となるよう設定箇所を記載している。（島根2号炉、柏崎6.7号炉と同様） ・設備名称等については、炉型の違い及びプラント設計の違いによる相違 ・安全機能に関して、炉型の相違により機能名称が異なるが、「止める」「冷やす」「閉じ込める」「ピット冷却」の達成を目的とした機能であることに相違はない。
系統	設備	区画番号	設置建屋	基本設定高さ ^{※1} (m)	個別測定高さ ^{※2} (m)	設定箇所	安全機能																																																																																						
換気空調系	B-非管理区域空調機器室電気ヒータ (3VSE2B)	3AB-D-N1	原子炉補助建屋	2.57	2.58	基本	㊦																																																																																						
換気空調系	C-非管理区域空調機器室電気ヒータ (3VSE2C)	3AB-D-N1	原子炉補助建屋	2.50	2.51	基本	㊦																																																																																						
換気空調系	D-非管理区域空調機器室電気ヒータ (3VSE2D)	3AB-D-N1	原子炉補助建屋	2.57	2.58	基本	㊦																																																																																						
換気空調系	A-制御用空気圧縮機室電気ヒータ (3VSE1A)	3RB-H-N2	原子炉建屋	2.80	2.80	基本	㊦																																																																																						
換気空調系	B-制御用空気圧縮機室電気ヒータ (3VSE1B)	3RB-H-N3	原子炉建屋	2.80	2.79	個別	㊦																																																																																						
換気空調系	A-原子炉補機冷却水サージタンク室室内空気温度(1) (3TS-2970)	3RB-A-N2	原子炉建屋	1.42	1.42	基本	㊦																																																																																						
換気空調系	A-原子炉補機冷却水サージタンク室室内空気温度(2) (3TS-2971)	3RB-A-N2	原子炉建屋	1.42	1.42	基本	㊦																																																																																						
換気空調系	B-原子炉補機冷却水サージタンク室室内空気温度(1) (3TS-2980)	3RB-A-N2	原子炉建屋	1.42	1.41	個別	㊦																																																																																						
換気空調系	B-原子炉補機冷却水サージタンク室室内空気温度(2) (3TS-2981)	3RB-A-N2	原子炉建屋	1.42	1.41	個別	㊦																																																																																						
①緊急時停止機能	⑥安全上時に重要な関連機能																																																																																												
②未臨界維持機能	⑦事故時のプラント状態の把握機能																																																																																												
③原子炉停止後の除熱機能	⑧制御室外からの安全停止機能																																																																																												
④炉心冷却機能	⑨ピット冷却機能																																																																																												
⑤放射性物質の閉じ込め機能	⑩ピット給水機能																																																																																												

赤字：設備、運用又は体制の相違（設計方針の相違）
 青字：記載箇所又は記載内容の相違（記載方針の相違）
 緑字：記載表現、設備名称の相違（実質的な相違なし）

大阪発電所3/4号炉	女川原子力発電所2号炉	泊発電所3号炉	相違理由																																																																																																										
		<p style="text-align: center;">表1 防護対象設備一覧 (32/35)</p> <table border="1" style="width: 100%; border-collapse: collapse;"> <thead> <tr> <th>系統</th> <th>設備</th> <th>区画番号</th> <th>設置棟屋</th> <th>基本設定高さ^{※1}(m)</th> <th>個別測定高さ^{※2}(m)</th> <th>設定箇所</th> <th>安全機能</th> </tr> </thead> <tbody> <tr> <td>換気空調系</td> <td>A-原子炉補機冷却水サーージタンク室電気ヒータ (3YSE3A) 出口空気温度 (2) (3TS-2973)</td> <td>3B2-A-N2</td> <td>原子炉棟屋</td> <td>2.65</td> <td>2.58</td> <td>個別</td> <td>⑧</td> </tr> <tr> <td>換気空調系</td> <td>B-原子炉補機冷却水サーージタンク室電気ヒータ (3YSE3B) 出口空気温度 (2) (3TS-2973)</td> <td>3B2-A-N2</td> <td>原子炉棟屋</td> <td>2.65</td> <td>2.57</td> <td>個別</td> <td>⑧</td> </tr> <tr> <td>換気空調系</td> <td>A-非管理区域空調機器室室内空気温度 (1) (3TS-2930)</td> <td>3AB-D-N1</td> <td>原子炉補助棟屋</td> <td>1.42</td> <td>1.42</td> <td>基本</td> <td>⑧</td> </tr> <tr> <td>換気空調系</td> <td>A-非管理区域空調機器室室内空気温度 (2) (3TS-2931)</td> <td>3AB-D-N1</td> <td>原子炉補助棟屋</td> <td>1.42</td> <td>1.42</td> <td>基本</td> <td>⑧</td> </tr> <tr> <td>換気空調系</td> <td>B-非管理区域空調機器室室内空気温度 (1) (3TS-2934)</td> <td>3AB-D-N1</td> <td>原子炉補助棟屋</td> <td>1.42</td> <td>1.41</td> <td>個別</td> <td>⑧</td> </tr> <tr> <td>換気空調系</td> <td>B-非管理区域空調機器室室内空気温度 (2) (3TS-2935)</td> <td>3AB-D-N1</td> <td>原子炉補助棟屋</td> <td>1.42</td> <td>1.42</td> <td>基本</td> <td>⑧</td> </tr> <tr> <td>換気空調系</td> <td>C-非管理区域空調機器室室内空気温度 (1) (3TS-2950)</td> <td>3AB-D-N1</td> <td>原子炉補助棟屋</td> <td>1.42</td> <td>1.42</td> <td>基本</td> <td>⑧</td> </tr> <tr> <td>換気空調系</td> <td>C-非管理区域空調機器室室内空気温度 (2) (3TS-2951)</td> <td>3AB-D-N1</td> <td>原子炉補助棟屋</td> <td>1.42</td> <td>1.42</td> <td>基本</td> <td>⑧</td> </tr> <tr> <td>換気空調系</td> <td>D-非管理区域空調機器室室内空気温度 (1) (3TS-2954)</td> <td>3AB-D-N1</td> <td>原子炉補助棟屋</td> <td>1.42</td> <td>1.42</td> <td>基本</td> <td>⑧</td> </tr> <tr> <td>換気空調系</td> <td>D-非管理区域空調機器室室内空気温度 (2) (3TS-2955)</td> <td>3AB-D-N1</td> <td>原子炉補助棟屋</td> <td>1.42</td> <td>1.41</td> <td>個別</td> <td>⑧</td> </tr> <tr> <td>換気空調系</td> <td>A-非管理区域空調機器室電気ヒータ (3YSE2A) 出口空気温度 (2) (3TS-2933)</td> <td>3AB-D-N1</td> <td>原子炉補助棟屋</td> <td>2.65</td> <td>2.53</td> <td>個別</td> <td>⑧</td> </tr> </tbody> </table> <p>※1：保守的に機能喪失すると仮定した床面からの高さ ※2：設水により機能喪失する床面からの高さ</p> <table style="width: 100%; font-size: small;"> <tr> <td>①緊急時停止機能</td> <td>②未臨界維持機能</td> <td>③原子炉停止後の除熱機能</td> <td>④炉心冷却機能</td> <td>⑤放射性物質の閉じ込め機能</td> </tr> <tr> <td>⑥安全上特に重要な関連機能</td> <td>⑦事故時のプラント状態の把握機能</td> <td>⑧制御室外からの安全停止機能</td> <td>⑨ピット冷却機能</td> <td>⑩ピット給水機能</td> </tr> </table>	系統	設備	区画番号	設置棟屋	基本設定高さ ^{※1} (m)	個別測定高さ ^{※2} (m)	設定箇所	安全機能	換気空調系	A-原子炉補機冷却水サーージタンク室電気ヒータ (3YSE3A) 出口空気温度 (2) (3TS-2973)	3B2-A-N2	原子炉棟屋	2.65	2.58	個別	⑧	換気空調系	B-原子炉補機冷却水サーージタンク室電気ヒータ (3YSE3B) 出口空気温度 (2) (3TS-2973)	3B2-A-N2	原子炉棟屋	2.65	2.57	個別	⑧	換気空調系	A-非管理区域空調機器室室内空気温度 (1) (3TS-2930)	3AB-D-N1	原子炉補助棟屋	1.42	1.42	基本	⑧	換気空調系	A-非管理区域空調機器室室内空気温度 (2) (3TS-2931)	3AB-D-N1	原子炉補助棟屋	1.42	1.42	基本	⑧	換気空調系	B-非管理区域空調機器室室内空気温度 (1) (3TS-2934)	3AB-D-N1	原子炉補助棟屋	1.42	1.41	個別	⑧	換気空調系	B-非管理区域空調機器室室内空気温度 (2) (3TS-2935)	3AB-D-N1	原子炉補助棟屋	1.42	1.42	基本	⑧	換気空調系	C-非管理区域空調機器室室内空気温度 (1) (3TS-2950)	3AB-D-N1	原子炉補助棟屋	1.42	1.42	基本	⑧	換気空調系	C-非管理区域空調機器室室内空気温度 (2) (3TS-2951)	3AB-D-N1	原子炉補助棟屋	1.42	1.42	基本	⑧	換気空調系	D-非管理区域空調機器室室内空気温度 (1) (3TS-2954)	3AB-D-N1	原子炉補助棟屋	1.42	1.42	基本	⑧	換気空調系	D-非管理区域空調機器室室内空気温度 (2) (3TS-2955)	3AB-D-N1	原子炉補助棟屋	1.42	1.41	個別	⑧	換気空調系	A-非管理区域空調機器室電気ヒータ (3YSE2A) 出口空気温度 (2) (3TS-2933)	3AB-D-N1	原子炉補助棟屋	2.65	2.53	個別	⑧	①緊急時停止機能	②未臨界維持機能	③原子炉停止後の除熱機能	④炉心冷却機能	⑤放射性物質の閉じ込め機能	⑥安全上特に重要な関連機能	⑦事故時のプラント状態の把握機能	⑧制御室外からの安全停止機能	⑨ピット冷却機能	⑩ピット給水機能	<p>【女川】</p> <p>記載方針の相違 設計方針の相違</p> <p>・泊では評価ガイドの要求に則り、機能喪失高さは、保守的に機能喪失すると仮定した高さである「評価高さ（基本設定箇所）」を標準としているが、評価高さで没水してしまう機器については「実力高さ（個別測定箇所）」を適用している。</p> <p>上記を踏まえ、表1には防護対象設備の「基本設定箇所」と「個別測定箇所」の機能喪失高さを併記し、どちらを採用しているか明確となるよう設定箇所を記載している。（島根2号炉、柏崎6.7号炉と同様）</p> <p>・設備名称等については、炉型の違い及びプラント設計の違いによる相違</p> <p>・安全機能に関して、炉型の相違により機能名称が異なるが、「止める」「冷やす」「閉じ込める」「ピット冷却」の達成を目的とした機能であることに相違はない。</p>
系統	設備	区画番号	設置棟屋	基本設定高さ ^{※1} (m)	個別測定高さ ^{※2} (m)	設定箇所	安全機能																																																																																																						
換気空調系	A-原子炉補機冷却水サーージタンク室電気ヒータ (3YSE3A) 出口空気温度 (2) (3TS-2973)	3B2-A-N2	原子炉棟屋	2.65	2.58	個別	⑧																																																																																																						
換気空調系	B-原子炉補機冷却水サーージタンク室電気ヒータ (3YSE3B) 出口空気温度 (2) (3TS-2973)	3B2-A-N2	原子炉棟屋	2.65	2.57	個別	⑧																																																																																																						
換気空調系	A-非管理区域空調機器室室内空気温度 (1) (3TS-2930)	3AB-D-N1	原子炉補助棟屋	1.42	1.42	基本	⑧																																																																																																						
換気空調系	A-非管理区域空調機器室室内空気温度 (2) (3TS-2931)	3AB-D-N1	原子炉補助棟屋	1.42	1.42	基本	⑧																																																																																																						
換気空調系	B-非管理区域空調機器室室内空気温度 (1) (3TS-2934)	3AB-D-N1	原子炉補助棟屋	1.42	1.41	個別	⑧																																																																																																						
換気空調系	B-非管理区域空調機器室室内空気温度 (2) (3TS-2935)	3AB-D-N1	原子炉補助棟屋	1.42	1.42	基本	⑧																																																																																																						
換気空調系	C-非管理区域空調機器室室内空気温度 (1) (3TS-2950)	3AB-D-N1	原子炉補助棟屋	1.42	1.42	基本	⑧																																																																																																						
換気空調系	C-非管理区域空調機器室室内空気温度 (2) (3TS-2951)	3AB-D-N1	原子炉補助棟屋	1.42	1.42	基本	⑧																																																																																																						
換気空調系	D-非管理区域空調機器室室内空気温度 (1) (3TS-2954)	3AB-D-N1	原子炉補助棟屋	1.42	1.42	基本	⑧																																																																																																						
換気空調系	D-非管理区域空調機器室室内空気温度 (2) (3TS-2955)	3AB-D-N1	原子炉補助棟屋	1.42	1.41	個別	⑧																																																																																																						
換気空調系	A-非管理区域空調機器室電気ヒータ (3YSE2A) 出口空気温度 (2) (3TS-2933)	3AB-D-N1	原子炉補助棟屋	2.65	2.53	個別	⑧																																																																																																						
①緊急時停止機能	②未臨界維持機能	③原子炉停止後の除熱機能	④炉心冷却機能	⑤放射性物質の閉じ込め機能																																																																																																									
⑥安全上特に重要な関連機能	⑦事故時のプラント状態の把握機能	⑧制御室外からの安全停止機能	⑨ピット冷却機能	⑩ピット給水機能																																																																																																									

赤字：設備、運用又は体制の相違（設計方針の相違）
 青字：記載箇所又は記載内容の相違（記載方針の相違）
 緑字：記載表現、設備名称の相違（実質的な相違なし）

大阪発電所3/4号炉	女川原子力発電所2号炉	泊発電所3号炉	相違理由																																																																																										
		<p style="text-align: center;">表1 防護対象設備一覧 (33/35)</p> <table border="1" style="width: 100%; border-collapse: collapse;"> <thead> <tr> <th>系統</th> <th>設備</th> <th>区画番号</th> <th>設置建屋</th> <th>基本設定高さ^{※1}(m)</th> <th>個別測定高さ^{※2}(m)</th> <th>設定箇所</th> <th>安全機能</th> </tr> </thead> <tbody> <tr> <td>換気空調系</td> <td>B-非管理区域空調機器室電気ヒータ (3VSE2B) 出口空気温度(2) (3TS-2937)</td> <td>3AB-D-N1</td> <td>原子炉補助建屋</td> <td>2.72</td> <td>2.65</td> <td>個別</td> <td>⑥</td> </tr> <tr> <td>換気空調系</td> <td>C-非管理区域空調機器室電気ヒータ (3VSE2C) 出口空気温度(2) (3TS-2953)</td> <td>3AB-D-N1</td> <td>原子炉補助建屋</td> <td>2.65</td> <td>2.48</td> <td>個別</td> <td>⑥</td> </tr> <tr> <td>換気空調系</td> <td>D-非管理区域空調機器室電気ヒータ (3VSE2D) 出口空気温度(2) (3TS-2957)</td> <td>3AB-D-N1</td> <td>原子炉補助建屋</td> <td>2.72</td> <td>2.64</td> <td>個別</td> <td>⑥</td> </tr> <tr> <td>換気空調系</td> <td>A-制御用空気圧縮機室室内空気温度(5) (3TS-2910)</td> <td>3BD-H-N2</td> <td>原子炉建屋</td> <td>1.42</td> <td>1.40</td> <td>個別</td> <td>⑥</td> </tr> <tr> <td>換気空調系</td> <td>A-制御用空気圧縮機室室内空気温度(6) (3TS-2911)</td> <td>3BD-H-N2</td> <td>原子炉建屋</td> <td>1.42</td> <td>1.39</td> <td>個別</td> <td>⑥</td> </tr> <tr> <td>換気空調系</td> <td>B-制御用空気圧縮機室室内空気温度(5) (3TS-2920)</td> <td>3BD-H-N3</td> <td>原子炉建屋</td> <td>1.42</td> <td>1.40</td> <td>個別</td> <td>⑥</td> </tr> <tr> <td>換気空調系</td> <td>B-制御用空気圧縮機室室内空気温度(6) (3TS-2921)</td> <td>3BD-H-N3</td> <td>原子炉建屋</td> <td>1.42</td> <td>1.40</td> <td>個別</td> <td>⑥</td> </tr> <tr> <td>換気空調系</td> <td>A-制御用空気圧縮機室電気ヒータ (3VSE1A) 出口空気温度(2) (3TS-2913)</td> <td>3BD-H-N2</td> <td>原子炉建屋</td> <td>2.89</td> <td>2.82</td> <td>個別</td> <td>⑥</td> </tr> <tr> <td>換気空調系</td> <td>B-制御用空気圧縮機室電気ヒータ (3VSE1B) 出口空気温度(2) (3TS-2923)</td> <td>3BD-H-N3</td> <td>原子炉建屋</td> <td>2.89</td> <td>2.82</td> <td>個別</td> <td>⑥</td> </tr> <tr> <td>空調用冷水系</td> <td>A-空調用冷水ポンプ (3CHP1A)</td> <td>3BD-E-N4</td> <td>原子炉建屋</td> <td>2.43</td> <td>2.45</td> <td>基本</td> <td>⑥</td> </tr> </tbody> </table> <p>※1：保守的に機能喪失すると仮定した床面からの高さ ※2：浸水により機能喪失する床面からの高さ</p> <table style="width: 100%; border: none;"> <tr> <td style="width: 50%; border: none;"> ①緊急停止機能 ②床境界維持機能 ③原子炉停止後の除熱機能 ④炉心冷却機能 ⑤放射性物質の閉じ込め機能 </td> <td style="width: 50%; border: none;"> ⑥安全上特に重要な関連機能 ⑦事故時のプラント状態の把握機能 ⑧制御室外からの安全停止機能 ⑨ピット冷却機能 ⑩ピット給水機能 </td> </tr> </table>	系統	設備	区画番号	設置建屋	基本設定高さ ^{※1} (m)	個別測定高さ ^{※2} (m)	設定箇所	安全機能	換気空調系	B-非管理区域空調機器室電気ヒータ (3VSE2B) 出口空気温度(2) (3TS-2937)	3AB-D-N1	原子炉補助建屋	2.72	2.65	個別	⑥	換気空調系	C-非管理区域空調機器室電気ヒータ (3VSE2C) 出口空気温度(2) (3TS-2953)	3AB-D-N1	原子炉補助建屋	2.65	2.48	個別	⑥	換気空調系	D-非管理区域空調機器室電気ヒータ (3VSE2D) 出口空気温度(2) (3TS-2957)	3AB-D-N1	原子炉補助建屋	2.72	2.64	個別	⑥	換気空調系	A-制御用空気圧縮機室室内空気温度(5) (3TS-2910)	3BD-H-N2	原子炉建屋	1.42	1.40	個別	⑥	換気空調系	A-制御用空気圧縮機室室内空気温度(6) (3TS-2911)	3BD-H-N2	原子炉建屋	1.42	1.39	個別	⑥	換気空調系	B-制御用空気圧縮機室室内空気温度(5) (3TS-2920)	3BD-H-N3	原子炉建屋	1.42	1.40	個別	⑥	換気空調系	B-制御用空気圧縮機室室内空気温度(6) (3TS-2921)	3BD-H-N3	原子炉建屋	1.42	1.40	個別	⑥	換気空調系	A-制御用空気圧縮機室電気ヒータ (3VSE1A) 出口空気温度(2) (3TS-2913)	3BD-H-N2	原子炉建屋	2.89	2.82	個別	⑥	換気空調系	B-制御用空気圧縮機室電気ヒータ (3VSE1B) 出口空気温度(2) (3TS-2923)	3BD-H-N3	原子炉建屋	2.89	2.82	個別	⑥	空調用冷水系	A-空調用冷水ポンプ (3CHP1A)	3BD-E-N4	原子炉建屋	2.43	2.45	基本	⑥	①緊急停止機能 ②床境界維持機能 ③原子炉停止後の除熱機能 ④炉心冷却機能 ⑤放射性物質の閉じ込め機能	⑥安全上特に重要な関連機能 ⑦事故時のプラント状態の把握機能 ⑧制御室外からの安全停止機能 ⑨ピット冷却機能 ⑩ピット給水機能	<p>【女川】</p> <p><u>記載方針の相違</u> <u>設計方針の相違</u></p> <p>・泊では評価ガイドの要求に則り、機能喪失高さは、保守的に機能喪失すると仮定した高さである「評価高さ（基本設定箇所）」を標準としているが、評価高さで没水してしまう機器については「実力高さ（個別測定箇所）」を適用している。</p> <p>上記を踏まえ、表1には防護対象設備の「基本設定箇所」と「個別測定箇所」の機能喪失高さを併記し、どちらを採用しているか明確となるよう設定箇所を記載している。（島根2号炉、柏崎6.7号炉と同様）</p> <p>・設備名称等については、炉型の違い及びプラント設計の違いによる相違</p> <p>・安全機能に関して、炉型の相違により機能名称が異なるが、「止める」「冷やす」「閉じ込める」「ピット冷却」の達成を目的とした機能であることに相違はない。</p>
系統	設備	区画番号	設置建屋	基本設定高さ ^{※1} (m)	個別測定高さ ^{※2} (m)	設定箇所	安全機能																																																																																						
換気空調系	B-非管理区域空調機器室電気ヒータ (3VSE2B) 出口空気温度(2) (3TS-2937)	3AB-D-N1	原子炉補助建屋	2.72	2.65	個別	⑥																																																																																						
換気空調系	C-非管理区域空調機器室電気ヒータ (3VSE2C) 出口空気温度(2) (3TS-2953)	3AB-D-N1	原子炉補助建屋	2.65	2.48	個別	⑥																																																																																						
換気空調系	D-非管理区域空調機器室電気ヒータ (3VSE2D) 出口空気温度(2) (3TS-2957)	3AB-D-N1	原子炉補助建屋	2.72	2.64	個別	⑥																																																																																						
換気空調系	A-制御用空気圧縮機室室内空気温度(5) (3TS-2910)	3BD-H-N2	原子炉建屋	1.42	1.40	個別	⑥																																																																																						
換気空調系	A-制御用空気圧縮機室室内空気温度(6) (3TS-2911)	3BD-H-N2	原子炉建屋	1.42	1.39	個別	⑥																																																																																						
換気空調系	B-制御用空気圧縮機室室内空気温度(5) (3TS-2920)	3BD-H-N3	原子炉建屋	1.42	1.40	個別	⑥																																																																																						
換気空調系	B-制御用空気圧縮機室室内空気温度(6) (3TS-2921)	3BD-H-N3	原子炉建屋	1.42	1.40	個別	⑥																																																																																						
換気空調系	A-制御用空気圧縮機室電気ヒータ (3VSE1A) 出口空気温度(2) (3TS-2913)	3BD-H-N2	原子炉建屋	2.89	2.82	個別	⑥																																																																																						
換気空調系	B-制御用空気圧縮機室電気ヒータ (3VSE1B) 出口空気温度(2) (3TS-2923)	3BD-H-N3	原子炉建屋	2.89	2.82	個別	⑥																																																																																						
空調用冷水系	A-空調用冷水ポンプ (3CHP1A)	3BD-E-N4	原子炉建屋	2.43	2.45	基本	⑥																																																																																						
①緊急停止機能 ②床境界維持機能 ③原子炉停止後の除熱機能 ④炉心冷却機能 ⑤放射性物質の閉じ込め機能	⑥安全上特に重要な関連機能 ⑦事故時のプラント状態の把握機能 ⑧制御室外からの安全停止機能 ⑨ピット冷却機能 ⑩ピット給水機能																																																																																												

赤字：設備、運用又は体制の相違（設計方針の相違）
 青字：記載箇所又は記載内容の相違（記載方針の相違）
 緑字：記載表現、設備名称の相違（実質的な相違なし）

大阪発電所3/4号炉	女川原子力発電所2号炉	泊発電所3号炉	相違理由																																																																																										
		<p style="text-align: center;">表1 防護対象設備一覧 (34/35)</p> <table border="1" data-bbox="1285 244 1856 710"> <thead> <tr> <th>系統</th> <th>設備</th> <th>区画番号</th> <th>設置建屋</th> <th>基本設定高さ^{※1} (m)</th> <th>個別測定高さ^{※2} (m)</th> <th>設定箇所</th> <th>安全機能</th> </tr> </thead> <tbody> <tr> <td>空調用冷水系</td> <td>B-空調用冷水ポンプ (SCHP1B)</td> <td>3B-K-N4</td> <td>原子炉建屋</td> <td>2.43</td> <td>2.45</td> <td>基本</td> <td>㊸</td> </tr> <tr> <td>空調用冷水系</td> <td>C-空調用冷水ポンプ (SCHP1C)</td> <td>3B-K-N1</td> <td>原子炉建屋</td> <td>2.43</td> <td>2.45</td> <td>基本</td> <td>㊸</td> </tr> <tr> <td>空調用冷水系</td> <td>D-空調用冷水ポンプ (SCHP1D)</td> <td>3B-K-N1</td> <td>原子炉建屋</td> <td>2.43</td> <td>2.45</td> <td>基本</td> <td>㊸</td> </tr> <tr> <td>空調用冷水系</td> <td>A-空調用冷凍機 (3CHE1A)</td> <td>3B-K-N4</td> <td>原子炉建屋</td> <td>2.05</td> <td>2.27</td> <td>基本</td> <td>㊸</td> </tr> <tr> <td>空調用冷水系</td> <td>B-空調用冷凍機 (3CHE1B)</td> <td>3B-K-N4</td> <td>原子炉建屋</td> <td>2.05</td> <td>2.27</td> <td>基本</td> <td>㊸</td> </tr> <tr> <td>空調用冷水系</td> <td>C-空調用冷凍機 (3CHE1C)</td> <td>3B-K-N1</td> <td>原子炉建屋</td> <td>2.05</td> <td>2.27</td> <td>基本</td> <td>㊸</td> </tr> <tr> <td>空調用冷水系</td> <td>D-空調用冷凍機 (3CHE1D)</td> <td>3B-K-N1</td> <td>原子炉建屋</td> <td>2.05</td> <td>2.27</td> <td>基本</td> <td>㊸</td> </tr> <tr> <td>空調用冷水系</td> <td>A-安全補機閉閉器室給気ユニット冷水温度制御弁 (STCV-2774)</td> <td>3AB-D-N1</td> <td>原子炉補助建屋</td> <td>1.20</td> <td>1.96</td> <td>基本</td> <td>㊸</td> </tr> <tr> <td>空調用冷水系</td> <td>B-安全補機閉閉器室給気ユニット冷水温度制御弁 (STCV-2775)</td> <td>3AB-D-N1</td> <td>原子炉補助建屋</td> <td>1.20</td> <td>1.97</td> <td>基本</td> <td>㊸</td> </tr> </tbody> </table> <p>※1：保守的に機能喪失すると仮定した床面からの高さ ※2：浸水により機能喪失する床面からの高さ</p> <table border="0" data-bbox="1305 746 1765 818"> <tr> <td>①緊急時停止機能</td> <td>⑥安全上特に重要な関連機能</td> </tr> <tr> <td>②未臨界維持機能</td> <td>⑦事故時のプラント状態の把握機能</td> </tr> <tr> <td>③原子炉停止後の除熱機能</td> <td>⑧制御室外からの安全停止機能</td> </tr> <tr> <td>④中心冷却機能</td> <td>⑨ピット冷却機能</td> </tr> <tr> <td>⑤放射性物質の閉じ込め機能</td> <td>⑩ピット給水機能</td> </tr> </table>	系統	設備	区画番号	設置建屋	基本設定高さ ^{※1} (m)	個別測定高さ ^{※2} (m)	設定箇所	安全機能	空調用冷水系	B-空調用冷水ポンプ (SCHP1B)	3B-K-N4	原子炉建屋	2.43	2.45	基本	㊸	空調用冷水系	C-空調用冷水ポンプ (SCHP1C)	3B-K-N1	原子炉建屋	2.43	2.45	基本	㊸	空調用冷水系	D-空調用冷水ポンプ (SCHP1D)	3B-K-N1	原子炉建屋	2.43	2.45	基本	㊸	空調用冷水系	A-空調用冷凍機 (3CHE1A)	3B-K-N4	原子炉建屋	2.05	2.27	基本	㊸	空調用冷水系	B-空調用冷凍機 (3CHE1B)	3B-K-N4	原子炉建屋	2.05	2.27	基本	㊸	空調用冷水系	C-空調用冷凍機 (3CHE1C)	3B-K-N1	原子炉建屋	2.05	2.27	基本	㊸	空調用冷水系	D-空調用冷凍機 (3CHE1D)	3B-K-N1	原子炉建屋	2.05	2.27	基本	㊸	空調用冷水系	A-安全補機閉閉器室給気ユニット冷水温度制御弁 (STCV-2774)	3AB-D-N1	原子炉補助建屋	1.20	1.96	基本	㊸	空調用冷水系	B-安全補機閉閉器室給気ユニット冷水温度制御弁 (STCV-2775)	3AB-D-N1	原子炉補助建屋	1.20	1.97	基本	㊸	①緊急時停止機能	⑥安全上特に重要な関連機能	②未臨界維持機能	⑦事故時のプラント状態の把握機能	③原子炉停止後の除熱機能	⑧制御室外からの安全停止機能	④中心冷却機能	⑨ピット冷却機能	⑤放射性物質の閉じ込め機能	⑩ピット給水機能	<p>【女川】 <u>記載方針の相違</u> <u>設計方針の相違</u></p> <p>・泊では評価ガイドの要求に則り、機能喪失高さは、保守的に機能喪失すると仮定した高さである「評価高さ（基本設定箇所）」を標準としているが、評価高さで没水してしまう機器については「実力高さ（個別測定箇所）」を適用している。</p> <p>上記を踏まえ、表1には防護対象設備の「基本設定箇所」と「個別測定箇所」の機能喪失高さを併記し、どちらを採用しているか明確となるよう設定箇所を記載している。（島根2号炉、柏崎6.7号炉と同様）</p> <p>・設備名称等については、炉型の違い及びプラント設計の違いによる相違</p> <p>・安全機能に関して、炉型の相違により機能名称が異なるが、「止める」「冷やす」「閉じ込める」「ピット冷却」の達成を目的とした機能であることに相違はない。</p>
系統	設備	区画番号	設置建屋	基本設定高さ ^{※1} (m)	個別測定高さ ^{※2} (m)	設定箇所	安全機能																																																																																						
空調用冷水系	B-空調用冷水ポンプ (SCHP1B)	3B-K-N4	原子炉建屋	2.43	2.45	基本	㊸																																																																																						
空調用冷水系	C-空調用冷水ポンプ (SCHP1C)	3B-K-N1	原子炉建屋	2.43	2.45	基本	㊸																																																																																						
空調用冷水系	D-空調用冷水ポンプ (SCHP1D)	3B-K-N1	原子炉建屋	2.43	2.45	基本	㊸																																																																																						
空調用冷水系	A-空調用冷凍機 (3CHE1A)	3B-K-N4	原子炉建屋	2.05	2.27	基本	㊸																																																																																						
空調用冷水系	B-空調用冷凍機 (3CHE1B)	3B-K-N4	原子炉建屋	2.05	2.27	基本	㊸																																																																																						
空調用冷水系	C-空調用冷凍機 (3CHE1C)	3B-K-N1	原子炉建屋	2.05	2.27	基本	㊸																																																																																						
空調用冷水系	D-空調用冷凍機 (3CHE1D)	3B-K-N1	原子炉建屋	2.05	2.27	基本	㊸																																																																																						
空調用冷水系	A-安全補機閉閉器室給気ユニット冷水温度制御弁 (STCV-2774)	3AB-D-N1	原子炉補助建屋	1.20	1.96	基本	㊸																																																																																						
空調用冷水系	B-安全補機閉閉器室給気ユニット冷水温度制御弁 (STCV-2775)	3AB-D-N1	原子炉補助建屋	1.20	1.97	基本	㊸																																																																																						
①緊急時停止機能	⑥安全上特に重要な関連機能																																																																																												
②未臨界維持機能	⑦事故時のプラント状態の把握機能																																																																																												
③原子炉停止後の除熱機能	⑧制御室外からの安全停止機能																																																																																												
④中心冷却機能	⑨ピット冷却機能																																																																																												
⑤放射性物質の閉じ込め機能	⑩ピット給水機能																																																																																												

赤字：設備、運用又は体制の相違（設計方針の相違）
 青字：記載箇所又は記載内容の相違（記載方針の相違）
 緑字：記載表現、設備名称の相違（実質的な相違なし）

大阪発電所3/4号炉	女川原子力発電所2号炉	泊発電所3号炉	相違理由																																																																																																		
		<p style="text-align: center;">表1 防護対象設備一覧 (35/35)</p> <table border="1" style="width: 100%; border-collapse: collapse;"> <thead> <tr> <th>系統</th> <th>設備</th> <th>区画番号</th> <th>設置建屋</th> <th>基本設定高さ^{※1} (m)</th> <th>個別測定高さ^{※2} (m)</th> <th>設定箇所</th> <th>安全機能</th> </tr> </thead> <tbody> <tr> <td>空調用冷水系</td> <td>A-中央制御室給気ユニット 冷水温度制御弁 (3TCV-2827)</td> <td>3AB-D-N1</td> <td>原子炉補助建屋</td> <td>1.20</td> <td>1.77</td> <td>基本</td> <td>⑥</td> </tr> <tr> <td>空調用冷水系</td> <td>B-中央制御室給気ユニット 冷水温度制御弁 (3TCV-2828)</td> <td>3AB-D-N1</td> <td>原子炉補助建屋</td> <td>1.20</td> <td>1.77</td> <td>基本</td> <td>⑥</td> </tr> <tr> <td>空調用冷水系</td> <td>空調用冷水A母管入口隔離弁 (3V-CI-012A)</td> <td>3RB-K-N4</td> <td>原子炉建屋</td> <td>2.55</td> <td>2.97</td> <td>基本</td> <td>⑥</td> </tr> <tr> <td>空調用冷水系</td> <td>空調用冷水B母管入口隔離弁 (3V-CI-012B)</td> <td>3RB-K-N1</td> <td>原子炉建屋</td> <td>2.53</td> <td>2.97</td> <td>基本</td> <td>⑥</td> </tr> <tr> <td>空調用冷水系</td> <td>空調用冷水C母管入口隔離弁 (3V-CI-012C)</td> <td>3RB-K-N4</td> <td>原子炉建屋</td> <td>2.53</td> <td>2.86</td> <td>基本</td> <td>⑥</td> </tr> <tr> <td>空調用冷水系</td> <td>空調用冷水C母管出口隔離弁 (3V-CI-013)</td> <td>3RB-K-N4</td> <td>原子炉建屋</td> <td>2.65</td> <td>2.98</td> <td>基本</td> <td>⑥</td> </tr> <tr> <td>関連設備</td> <td>A-空調用冷凍機盤 (3VCPA)</td> <td>3RB-K-N4</td> <td>原子炉建屋</td> <td>2.25</td> <td>2.23</td> <td>個別</td> <td>⑥</td> </tr> <tr> <td>関連設備</td> <td>B-空調用冷凍機盤 (3VCPB)</td> <td>3RB-K-N4</td> <td>原子炉建屋</td> <td>2.25</td> <td>2.22</td> <td>個別</td> <td>⑥</td> </tr> <tr> <td>関連設備</td> <td>C-空調用冷凍機盤 (3VCPD)</td> <td>3RB-K-N1</td> <td>原子炉建屋</td> <td>2.25</td> <td>2.23</td> <td>個別</td> <td>⑥</td> </tr> <tr> <td>関連設備</td> <td>D-空調用冷凍機盤 (3VCPD)</td> <td>3RB-K-N1</td> <td>原子炉建屋</td> <td>2.25</td> <td>2.23</td> <td>個別</td> <td>⑥</td> </tr> </tbody> </table> <p>※1：保守的に機能喪失すると仮定した床面からの高さ ※2：設水により機能喪失する床面からの高さ</p> <table style="width: 100%; font-size: small;"> <tr> <td>①緊急時停止機能</td> <td>⑥安全上特に重要な関連機能</td> </tr> <tr> <td>②未臨界維持機能</td> <td>⑦事故時のプラント状態の把握機能</td> </tr> <tr> <td>③原子炉停止後の降熱機能</td> <td>⑧制御室外からの安全停止機能</td> </tr> <tr> <td>④炉心冷却機能</td> <td>⑨ピット冷却機能</td> </tr> <tr> <td>⑤放射性物質の閉じ込め機能</td> <td>⑩ピット給水機能</td> </tr> </table>	系統	設備	区画番号	設置建屋	基本設定高さ ^{※1} (m)	個別測定高さ ^{※2} (m)	設定箇所	安全機能	空調用冷水系	A-中央制御室給気ユニット 冷水温度制御弁 (3TCV-2827)	3AB-D-N1	原子炉補助建屋	1.20	1.77	基本	⑥	空調用冷水系	B-中央制御室給気ユニット 冷水温度制御弁 (3TCV-2828)	3AB-D-N1	原子炉補助建屋	1.20	1.77	基本	⑥	空調用冷水系	空調用冷水A母管入口隔離弁 (3V-CI-012A)	3RB-K-N4	原子炉建屋	2.55	2.97	基本	⑥	空調用冷水系	空調用冷水B母管入口隔離弁 (3V-CI-012B)	3RB-K-N1	原子炉建屋	2.53	2.97	基本	⑥	空調用冷水系	空調用冷水C母管入口隔離弁 (3V-CI-012C)	3RB-K-N4	原子炉建屋	2.53	2.86	基本	⑥	空調用冷水系	空調用冷水C母管出口隔離弁 (3V-CI-013)	3RB-K-N4	原子炉建屋	2.65	2.98	基本	⑥	関連設備	A-空調用冷凍機盤 (3VCPA)	3RB-K-N4	原子炉建屋	2.25	2.23	個別	⑥	関連設備	B-空調用冷凍機盤 (3VCPB)	3RB-K-N4	原子炉建屋	2.25	2.22	個別	⑥	関連設備	C-空調用冷凍機盤 (3VCPD)	3RB-K-N1	原子炉建屋	2.25	2.23	個別	⑥	関連設備	D-空調用冷凍機盤 (3VCPD)	3RB-K-N1	原子炉建屋	2.25	2.23	個別	⑥	①緊急時停止機能	⑥安全上特に重要な関連機能	②未臨界維持機能	⑦事故時のプラント状態の把握機能	③原子炉停止後の降熱機能	⑧制御室外からの安全停止機能	④炉心冷却機能	⑨ピット冷却機能	⑤放射性物質の閉じ込め機能	⑩ピット給水機能	<p>【女川】</p> <p><u>記載方針の相違</u> <u>設計方針の相違</u></p> <p>・泊では評価ガイドの要求に則り、機能喪失高さは、保守的に機能喪失すると仮定した高さである「評価高さ（基本設定箇所）」を標準としているが、評価高さで没水してしまう機器については「実力高さ（個別測定箇所）」を適用している。</p> <p>上記を踏まえ、表1には防護対象設備の「基本設定箇所」と「個別測定箇所」の機能喪失高さを併記し、どちらを採用しているか明確となるよう設定箇所を記載している。（島根2号炉、柏崎6,7号炉と同様）</p> <p>・設備名称等については、炉型の違い及びプラント設計の違いによる相違</p> <p>・安全機能に関して、炉型の相違により機能名称が異なるが、「止める」「冷やす」「閉じ込める」「ピット冷却」の達成を目的とした機能であることに相違はない。</p>
系統	設備	区画番号	設置建屋	基本設定高さ ^{※1} (m)	個別測定高さ ^{※2} (m)	設定箇所	安全機能																																																																																														
空調用冷水系	A-中央制御室給気ユニット 冷水温度制御弁 (3TCV-2827)	3AB-D-N1	原子炉補助建屋	1.20	1.77	基本	⑥																																																																																														
空調用冷水系	B-中央制御室給気ユニット 冷水温度制御弁 (3TCV-2828)	3AB-D-N1	原子炉補助建屋	1.20	1.77	基本	⑥																																																																																														
空調用冷水系	空調用冷水A母管入口隔離弁 (3V-CI-012A)	3RB-K-N4	原子炉建屋	2.55	2.97	基本	⑥																																																																																														
空調用冷水系	空調用冷水B母管入口隔離弁 (3V-CI-012B)	3RB-K-N1	原子炉建屋	2.53	2.97	基本	⑥																																																																																														
空調用冷水系	空調用冷水C母管入口隔離弁 (3V-CI-012C)	3RB-K-N4	原子炉建屋	2.53	2.86	基本	⑥																																																																																														
空調用冷水系	空調用冷水C母管出口隔離弁 (3V-CI-013)	3RB-K-N4	原子炉建屋	2.65	2.98	基本	⑥																																																																																														
関連設備	A-空調用冷凍機盤 (3VCPA)	3RB-K-N4	原子炉建屋	2.25	2.23	個別	⑥																																																																																														
関連設備	B-空調用冷凍機盤 (3VCPB)	3RB-K-N4	原子炉建屋	2.25	2.22	個別	⑥																																																																																														
関連設備	C-空調用冷凍機盤 (3VCPD)	3RB-K-N1	原子炉建屋	2.25	2.23	個別	⑥																																																																																														
関連設備	D-空調用冷凍機盤 (3VCPD)	3RB-K-N1	原子炉建屋	2.25	2.23	個別	⑥																																																																																														
①緊急時停止機能	⑥安全上特に重要な関連機能																																																																																																				
②未臨界維持機能	⑦事故時のプラント状態の把握機能																																																																																																				
③原子炉停止後の降熱機能	⑧制御室外からの安全停止機能																																																																																																				
④炉心冷却機能	⑨ピット冷却機能																																																																																																				
⑤放射性物質の閉じ込め機能	⑩ピット給水機能																																																																																																				

赤字：設備、運用又は体制の相違（設計方針の相違）
 青字：記載箇所又は記載内容の相違（記載方針の相違）
 緑字：記載表現、設備名称の相違（実質的な相違なし）

大阪発電所3/4号炉	女川原子力発電所2号炉	泊発電所3号炉	相違理由
<p>添付資料 1.2-2</p> <p>3. 機能喪失高さ 各機器における機能喪失高さの考え方を表1にまとめるとともに図2にポンプの例を示す。</p>	<p>添付資料 5</p> <p>機能喪失高さの考え方</p> <p>弁類、ポンプ類、ファン類、電気盤類、計器関係における機能喪失高さ設定の考え方を表1及び図1～図5にそれぞれ示す。</p> <div style="border: 1px solid black; padding: 5px;"> <p>【島根2号炉】 まとめ資料 p9条-別添1-添付1-1より抜粋</p> <p>1.1 機能喪失高さ</p> <p>機能喪失高さは「基本設定箇所」を基本とし、溢水水位に応じて機能喪失高さの実力値である「個別設定箇所」に見直す。</p> </div>	<p>添付資料 5</p> <p>機能喪失高さの考え方</p> <p>弁類、ポンプ類、ファン類、電気盤類、計器関係における機能喪失高さ設定の考え方を表1及び図1～図5にそれぞれ示す。</p> <p>機能喪失高さは「基本設定箇所」を基本とし、溢水水位に応じて機能喪失高さの実力値である「個別測定箇所」に見直す。</p>	<p>【女川】 <u>設計方針の相違</u></p> <ul style="list-style-type: none"> ・泊では評価ガイドの要求に則り、機能喪失高さは、保守的に機能喪失すると仮定した高さである「評価高さ（基本設定箇所）」を標準としているが、評価高さで没水してしまう機器については「実力高さ（個別測定箇所）」を適用している。 ・上記の機能喪失高さの設定方針は、先行審査プラントである島根2号炉及び柏崎6、7号炉で実績があり、女川2号炉においても、溢水水位に対して防護対象設備の機能喪失高さの裕度が小さい場合には、実際の機能喪失高さを実測することで実際には十分な裕度が確保されていることを確認している。 <p>【島根】 <u>記載表現の相違</u> 泊は資料間で「個別測定箇所」と記載統一している。</p> <p>【大阪】 <u>記載方針の相違</u> 女川審査実績の反映</p>

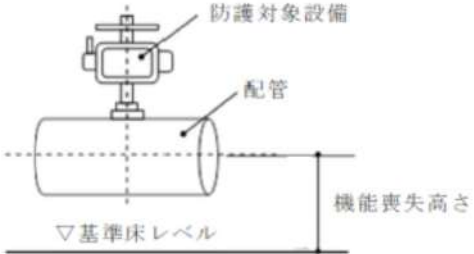
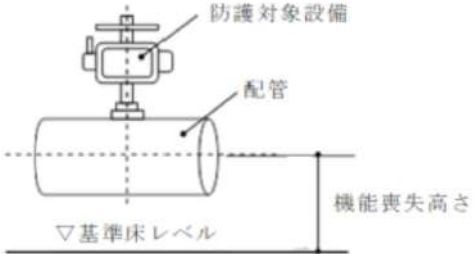
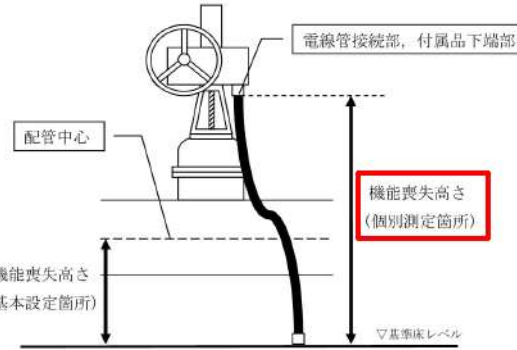

赤字：設備、運用又は体制の相違（設計方針の相違）
 青字：記載箇所又は記載内容の相違（記載方針の相違）
 緑字：記載表現、設備名称の相違（実質的な相違なし）

第9条 溢水による損傷の防止等（別添1添付資料5）

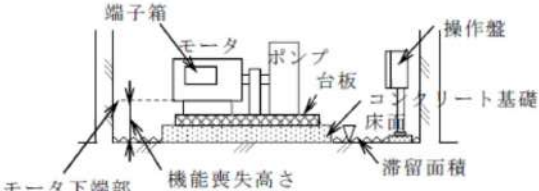
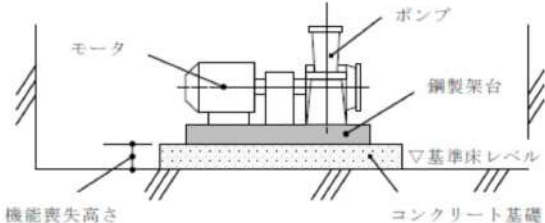
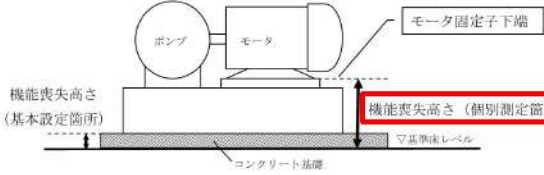

大阪発電所3/4号炉	女川原子力発電所2号炉	泊発電所3号炉	相違理由																																																															
<p>表1 各設備の機能喪失高さの考え方</p> <table border="1"> <thead> <tr> <th>機器</th> <th>機能喪失高さ</th> </tr> </thead> <tbody> <tr> <td>弁</td> <td>①電動弁：電動弁駆動装置下端部 ②空気作動弁：各付属品（アクチュエータ、電磁弁、減圧弁、リミットスイッチ）のうち、最低高さの付属品の下端部</td> </tr> <tr> <td>ダンパ</td> <td>各付属品（アクチュエータ、電磁弁、減圧弁、リミットスイッチ）のうち、最低高さの付属品の下端部</td> </tr> <tr> <td>ポンプ（操作盤含む）</td> <td>①ポンプ又はモータの低い方 ②ポンプは軸貫通部下端又は油タンクのエアブリーザ部の低い方 ③モータは下端部又は端子箱下端の低い方</td> </tr> <tr> <td>ファン</td> <td>モータは下端部又は端子箱下端の低い方</td> </tr> <tr> <td>盤</td> <td>盤内の最低高さの計器類の下端部</td> </tr> <tr> <td>計器</td> <td>計器本体下端又は伝送器下端の低い方</td> </tr> </tbody> </table>	機器	機能喪失高さ	弁	①電動弁：電動弁駆動装置下端部 ②空気作動弁：各付属品（アクチュエータ、電磁弁、減圧弁、リミットスイッチ）のうち、最低高さの付属品の下端部	ダンパ	各付属品（アクチュエータ、電磁弁、減圧弁、リミットスイッチ）のうち、最低高さの付属品の下端部	ポンプ（操作盤含む）	①ポンプ又はモータの低い方 ②ポンプは軸貫通部下端又は油タンクのエアブリーザ部の低い方 ③モータは下端部又は端子箱下端の低い方	ファン	モータは下端部又は端子箱下端の低い方	盤	盤内の最低高さの計器類の下端部	計器	計器本体下端又は伝送器下端の低い方	<p>表1 機能喪失高さ設定の考え方</p> <table border="1"> <thead> <tr> <th>機器</th> <th>機能喪失高さ</th> </tr> </thead> <tbody> <tr> <td>弁類</td> <td>弁が設置される配管の中心レベル</td> </tr> <tr> <td>ポンプ類</td> <td>コンクリート基礎の高さ</td> </tr> <tr> <td>ファン類</td> <td>コンクリート基礎の高さ</td> </tr> <tr> <td>電気盤類</td> <td>対象機器の設置レベル</td> </tr> <tr> <td>計器関係</td> <td>計器下端レベル</td> </tr> </tbody> </table> <p>【島根2号炉】 まとめ資料 p9条-別添1-添付1-1より抜粋</p> <table border="1"> <thead> <tr> <th rowspan="2">設備</th> <th colspan="2">機能喪失高さ</th> </tr> <tr> <th>基本設定箇所*</th> <th>個別設定箇所</th> </tr> </thead> <tbody> <tr> <td>ポンプ/電動機</td> <td>・ポンプベース高さ</td> <td>・電動機下端部 ・電線管接続部下端部</td> </tr> <tr> <td>空気作動弁/電動弁</td> <td>・取付け配管中心高さ</td> <td>・制御ボックス下端部 ・電線管接続部下端部</td> </tr> <tr> <td>盤</td> <td>・盤ベース高さ</td> <td>・開口部下端部 ・計器下端部 ・電線管接続部下端部</td> </tr> <tr> <td>計器ラック</td> <td>・計器ドレン弁高さ</td> <td>・計器下端部 ・電線管接続部下端部 ・端子箱下端部</td> </tr> </tbody> </table> <p>※ 保守的に機能喪失すると仮定した部位</p>	機器	機能喪失高さ	弁類	弁が設置される配管の中心レベル	ポンプ類	コンクリート基礎の高さ	ファン類	コンクリート基礎の高さ	電気盤類	対象機器の設置レベル	計器関係	計器下端レベル	設備	機能喪失高さ		基本設定箇所*	個別設定箇所	ポンプ/電動機	・ポンプベース高さ	・電動機下端部 ・電線管接続部下端部	空気作動弁/電動弁	・取付け配管中心高さ	・制御ボックス下端部 ・電線管接続部下端部	盤	・盤ベース高さ	・開口部下端部 ・計器下端部 ・電線管接続部下端部	計器ラック	・計器ドレン弁高さ	・計器下端部 ・電線管接続部下端部 ・端子箱下端部	<p>表1 機能喪失高さ設定の考え方</p> <table border="1"> <thead> <tr> <th rowspan="2">機器</th> <th colspan="2">機能喪失高さ</th> </tr> <tr> <th>基本設定箇所*</th> <th>個別測定箇所</th> </tr> </thead> <tbody> <tr> <td>弁類</td> <td>弁が設置される配管の中心レベル</td> <td>①電動弁：電動弁駆動装置の電線管接続部下端 ②空気作動弁：各付属品（アクチュエータ、電磁弁、減圧弁、リミットスイッチ等）のうち、最低高さの付属品の下端部</td> </tr> <tr> <td>ポンプ類</td> <td>コンクリート基礎の高さ</td> <td>ポンプあるいは電動機のいづれか低い箇所 ①ポンプは軸貫通部又は油タンクのエアブリーザ部の低い方 ②電動機は下端部</td> </tr> <tr> <td>ファン類</td> <td>コンクリート基礎の高さ</td> <td>電動機の下端部又は端子箱下端の低い方</td> </tr> <tr> <td>電気盤類（操作盤含む）</td> <td>対象機器の設置レベル</td> <td>盤内機器（端子台、リレー、変圧器、しゃ断器等）の最下部</td> </tr> <tr> <td>計器関係</td> <td>計器下端レベル（計器箱に収納されているものは箱の下端レベル）</td> <td>計器本体の電線管接続部下端又は伝送器下端の低い方</td> </tr> </tbody> </table> <p>※ 保守的に機能喪失すると仮定した部位</p>	機器	機能喪失高さ		基本設定箇所*	個別測定箇所	弁類	弁が設置される配管の中心レベル	①電動弁：電動弁駆動装置の電線管接続部下端 ②空気作動弁：各付属品（アクチュエータ、電磁弁、減圧弁、リミットスイッチ等）のうち、最低高さの付属品の下端部	ポンプ類	コンクリート基礎の高さ	ポンプあるいは電動機のいづれか低い箇所 ①ポンプは軸貫通部又は油タンクのエアブリーザ部の低い方 ②電動機は下端部	ファン類	コンクリート基礎の高さ	電動機の下端部又は端子箱下端の低い方	電気盤類（操作盤含む）	対象機器の設置レベル	盤内機器（端子台、リレー、変圧器、しゃ断器等）の最下部	計器関係	計器下端レベル（計器箱に収納されているものは箱の下端レベル）	計器本体の電線管接続部下端又は伝送器下端の低い方	<p>【女川】 <u>設計方針の相違</u> 泊は基本設定箇所と個別測定箇所を適用している。 （島根2号炉と同様）</p> <p>【大阪】 <u>記載方針の相違</u> 女川審査実績の反映</p>
機器	機能喪失高さ																																																																	
弁	①電動弁：電動弁駆動装置下端部 ②空気作動弁：各付属品（アクチュエータ、電磁弁、減圧弁、リミットスイッチ）のうち、最低高さの付属品の下端部																																																																	
ダンパ	各付属品（アクチュエータ、電磁弁、減圧弁、リミットスイッチ）のうち、最低高さの付属品の下端部																																																																	
ポンプ（操作盤含む）	①ポンプ又はモータの低い方 ②ポンプは軸貫通部下端又は油タンクのエアブリーザ部の低い方 ③モータは下端部又は端子箱下端の低い方																																																																	
ファン	モータは下端部又は端子箱下端の低い方																																																																	
盤	盤内の最低高さの計器類の下端部																																																																	
計器	計器本体下端又は伝送器下端の低い方																																																																	
機器	機能喪失高さ																																																																	
弁類	弁が設置される配管の中心レベル																																																																	
ポンプ類	コンクリート基礎の高さ																																																																	
ファン類	コンクリート基礎の高さ																																																																	
電気盤類	対象機器の設置レベル																																																																	
計器関係	計器下端レベル																																																																	
設備	機能喪失高さ																																																																	
	基本設定箇所*	個別設定箇所																																																																
ポンプ/電動機	・ポンプベース高さ	・電動機下端部 ・電線管接続部下端部																																																																
空気作動弁/電動弁	・取付け配管中心高さ	・制御ボックス下端部 ・電線管接続部下端部																																																																
盤	・盤ベース高さ	・開口部下端部 ・計器下端部 ・電線管接続部下端部																																																																
計器ラック	・計器ドレン弁高さ	・計器下端部 ・電線管接続部下端部 ・端子箱下端部																																																																
機器	機能喪失高さ																																																																	
	基本設定箇所*	個別測定箇所																																																																
弁類	弁が設置される配管の中心レベル	①電動弁：電動弁駆動装置の電線管接続部下端 ②空気作動弁：各付属品（アクチュエータ、電磁弁、減圧弁、リミットスイッチ等）のうち、最低高さの付属品の下端部																																																																
ポンプ類	コンクリート基礎の高さ	ポンプあるいは電動機のいづれか低い箇所 ①ポンプは軸貫通部又は油タンクのエアブリーザ部の低い方 ②電動機は下端部																																																																
ファン類	コンクリート基礎の高さ	電動機の下端部又は端子箱下端の低い方																																																																
電気盤類（操作盤含む）	対象機器の設置レベル	盤内機器（端子台、リレー、変圧器、しゃ断器等）の最下部																																																																
計器関係	計器下端レベル（計器箱に収納されているものは箱の下端レベル）	計器本体の電線管接続部下端又は伝送器下端の低い方																																																																
<p>【島根2号炉】 まとめ資料 p9条-別添1-添付1-2より抜粋</p>  <p>図1-2 機能喪失高さ（電動弁の例）</p>	 <p>図1 弁における機能喪失高さ</p>	 <p>図1 機能喪失高さ（電動弁の例）</p>	<p>【女川】 <u>設計方針の相違</u> 泊は基本設定箇所と個別測定箇所を適用している。 （島根2号炉と同様）</p> <p>【女川】 <u>記載方針の相違</u> 泊は機能喪失高さの個別測定箇所として、防護対象設備の構成部位のうち最も低い位置にある部位を選定していることから、図中の個別測定箇所の部位は一例として示している。具体的な個別測定箇所の位置は表1に示している。 （島根2号炉と同様）</p>																																																															

赤字：設備、運用又は体制の相違（設計方針の相違）
 青字：記載箇所又は記載内容の相違（記載方針の相違）
 緑字：記載表現、設備名称の相違（実質的な相違なし）

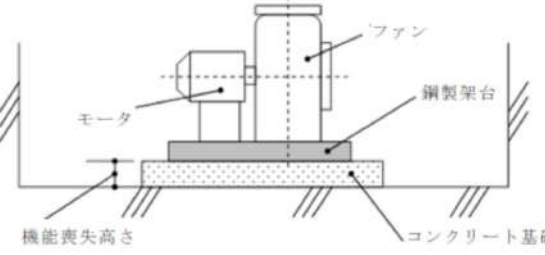
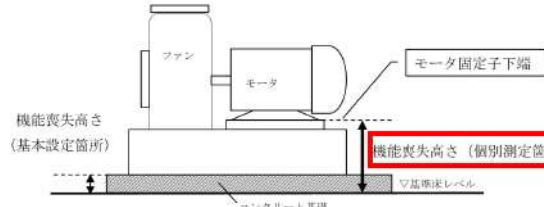
第9条 溢水による損傷の防止等（別添1添付資料5）

大阪発電所3/4号炉	女川原子力発電所2号炉	泊発電所3号炉	相違理由
 <p>端子箱 モータ ポンプ 台板 操作盤 モータ下端部 機能喪失高さ 滞留面積 コンクリート基礎</p> <p>図2 ポンプにおける機能喪失高さ</p>	 <p>モータ ポンプ 鋼製架台 機能喪失高さ ▽基準床レベル コンクリート基礎</p> <p>図2 ポンプにおける機能喪失高さ</p>	 <p>ポンプ モータ モータ固定子下端 機能喪失高さ（基本設定箇所） 機能喪失高さ（個別測定箇所） ▽基準床レベル コンクリート基礎</p> <p>図2 機能喪失高さ（ポンプの例）</p>	<p>【女川】 設計方針の相違 泊は基本設定箇所と個別測定箇所を適用している。 (島根2号炉と同様)</p> <p>【女川・大阪】 記載方針の相違 泊は機能喪失高さの個別測定箇所として、防護対象設備の構成部位のうち最も低い位置にある部位を選定していることから、図中の個別測定箇所の部位は一例として示している。具体的な個別測定箇所の位置は表1に示している。 (島根2号炉と同様)</p>
<p>【島根2号炉】 まとめ資料 p9条-別添1-添付1-2より抜粋</p>  <p>図1-1 機能喪失高さ（ポンプの例）</p> <p>本資料のうち、特記の内容は機密に関する事項のため公開できません。</p>	 <p>ファン モータ 鋼製架台 機能喪失高さ コンクリート基礎</p> <p>図3 ファンにおける機能喪失高さ</p>	 <p>ファン モータ モータ固定子下端 機能喪失高さ（基本設定箇所） 機能喪失高さ（個別測定箇所） ▽基準床レベル コンクリート基礎</p> <p>図3 機能喪失高さ（ファンの例）</p>	<p>【女川】 設計方針の相違 泊は基本設定箇所と個別測定箇所を適用している。 (島根2号炉と同様)</p> <p>【女川】 記載方針の相違 泊は機能喪失高さの個別測定箇所として、防護対象設備の構成部位のうち最も低い位置にある部位を選定していることから、図中の個別測定箇所の部位は一例として示している。具体的な個別測定箇所の位置は表1に示している。 (島根2号炉と同様)</p>

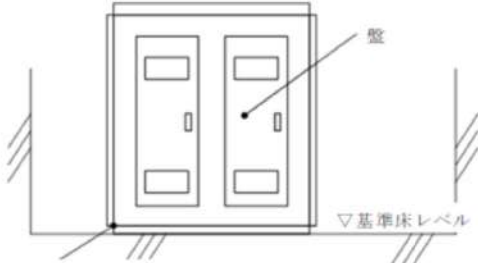
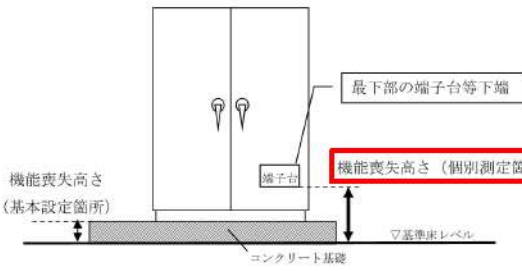
赤字：設備、運用又は体制の相違（設計方針の相違）
 青字：記載箇所又は記載内容の相違（記載方針の相違）
 緑字：記載表現、設備名称の相違（実質的な相違なし）

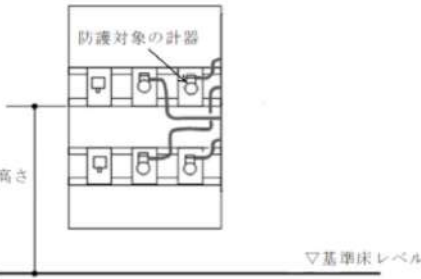
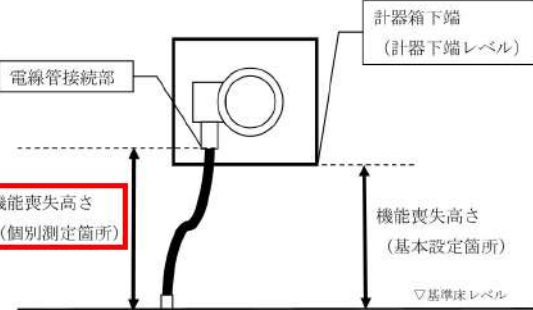
大阪発電所3/4号炉	女川原子力発電所2号炉	泊発電所3号炉	相違理由
<p>【島根2号炉】 まとめ資料 p9条-別添1-添付1-3より抜粋</p>  <p>図1-3 機能喪失高さ（盤の例）</p> <p>本資料のうち、枠線内の内容は機密に係る事項のため公開できません。</p>	 <p>図4 電気盤における機能喪失高さ</p>	 <p>図4 機能喪失高さ（盤の例）</p>	<p>【女川】 <u>設計方針の相違</u> 泊は基本設定箇所と個別測定箇所を適用している。 （島根2号炉と同様）</p> <p>【女川】 <u>記載方針の相違</u> 泊は機能喪失高さの個別測定箇所として、防護対象設備の構成部位のうち最も低い位置にある部位を選定していることから、図中の個別測定箇所の部位は一例として示している。具体的な個別測定箇所の位置は表1に示している。 （島根2号炉と同様）</p>
<p>【島根2号炉】 まとめ資料 p9条-別添1-添付1-4より抜粋</p>  <p>図1-5 機能喪失高さ（計器の例）</p> <p>本資料のうち、枠線内の内容は機密に係る事項のため公開できません。</p>	 <p>図5 計器における機能喪失高さ</p>	 <p>図5 機能喪失高さ（計器の例）</p>	<p>【女川】 <u>設計方針の相違</u> 泊は基本設定箇所と個別測定箇所を適用している。 （島根2号炉と同様）</p> <p>【女川】 <u>記載方針の相違</u> 泊は機能喪失高さの個別測定箇所として、防護対象設備の構成部位のうち最も低い位置にある部位を選定していることから、図中の個別測定箇所の部位は一例として示している。具体的な個別測定箇所の位置は表1に示している。 （島根2号炉と同様）</p>

赤字：設備、運用又は体制の相違（設計方針の相違）
 青字：記載箇所又は記載内容の相違（記載方針の相違）
 緑字：記載表現、設備名称の相違（実質的な相違なし）

大阪発電所3/4号炉	女川原子力発電所2号炉	泊発電所3号炉	相違理由
	<p style="text-align: right;">添付資料6</p> <p style="text-align: center;">溢水影響評価の対象外とした設備について</p> <p>1. 溢水影響評価から対象外とした設備 別添1-3の図3-1に示した選定フローにより溢水影響評価対象外とした設備について、系統、設備名及び対象外の理由をリストとしてまとめた。結果を表2に示す。 また、図3-1の選定フローにおける①～④の対象外理由について以下に示す。</p> <p>(1) ①「溢水により機能を喪失しない」について 容器、熱交換器、安全弁、逆止弁、手動弁、配管等の静的機器は、外部からの電源供給等が不要であることから、溢水の影響により外部からの電源供給や電気信号を喪失しても機能喪失はしないため、溢水影響がないとし溢水影響評価対象外とした。</p> <p>a. 配管・弁 例として、配管（材質 STPG370、口径 200A、公称肉厚 sch40（管の外径 216.3mm、管の厚さ 8.2mm）、許容引張応力 S=93MPa（常温））を設計・建設規格 PPD-3411（2）に基づき評価すると、2MPa以上の外圧に対して健全性が確保されるため、内部溢水影響評価上考慮する水頭に対しては十分な余裕がある。（図1参照） 弁は配管に対して肉厚であるため、同様に内部溢水影響評価上考慮する水頭に対して十分余裕がある。 また、弁の軸封部は、スタフィンボックス内に挿入したグランドパッキンを、押さえ金具で締め付ける構造であり、締め付けによって発生する面圧で、内部流体が外部に漏れ出ないようシールするものであるため、溢水によって弁グランドパッキンから内部への溢水の流入及びそれに伴う影響はない。</p>	<p style="text-align: right;">添付資料6</p> <p style="text-align: center;">溢水影響評価の対象外とした設備について</p> <p>1. 溢水影響評価から対象外とした設備 別添1-3の図3-1に示した選定フローにより溢水影響評価対象外とした設備について、系統、設備名及び対象外の理由をリストとしてまとめた。結果を表2に示す。 また、図3-1の選定フローにおける①～④の対象外理由について以下に示す。</p> <p>(1) ①「溢水により機能を喪失しない」について 容器、熱交換器、安全弁、逆止弁、手動弁、配管等の静的機器は、外部からの電源供給等が不要であることから、溢水の影響により外部からの電源供給や電気信号を喪失しても機能喪失はしないため、溢水影響がないとし溢水影響評価対象外とした。</p> <p>a. 配管・弁 例として、配管（材質 STPG370、口径 200A、公称肉厚 sch40（管の外径 216.3mm、管の厚さ 8.2mm）、許容引張応力 S=93MPa（常温））を設計・建設規格 PPD-3411（2）に基づき評価すると、2MPa以上の外圧に対して健全性が確保されるため、内部溢水影響評価上考慮する水頭に対しては十分な余裕がある。（図1参照） 弁は配管に対して肉厚であるため、同様に内部溢水影響評価上考慮する水頭に対して十分余裕がある。 また、弁の軸封部は、スタフィンボックス内に挿入したグランドパッキンを、押さえ金具で締め付ける構造であり、締め付けによって発生する面圧で、内部流体が外部に漏れ出ないようシールするものであるため、溢水によって弁グランドパッキンから内部への溢水の流入及びそれに伴う影響はない。</p>	<p>【大阪】 記載方針の相違 女川審査実績の反映</p>

赤字：設備、運用又は体制の相違（設計方針の相違）
 青字：記載箇所又は記載内容の相違（記載方針の相違）
 緑字：記載表現、設備名称の相違（実質的な相違なし）

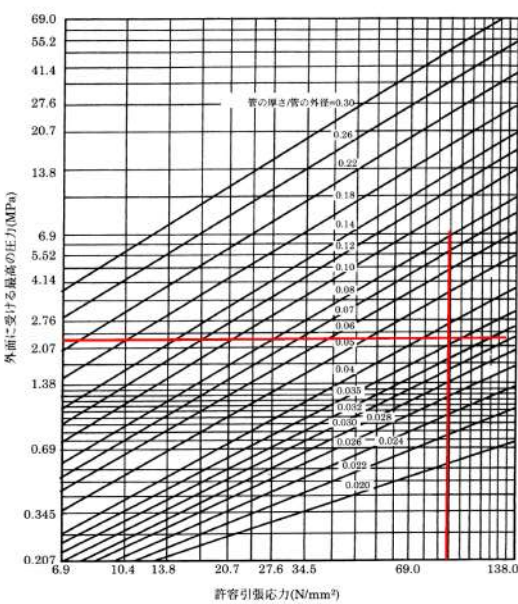
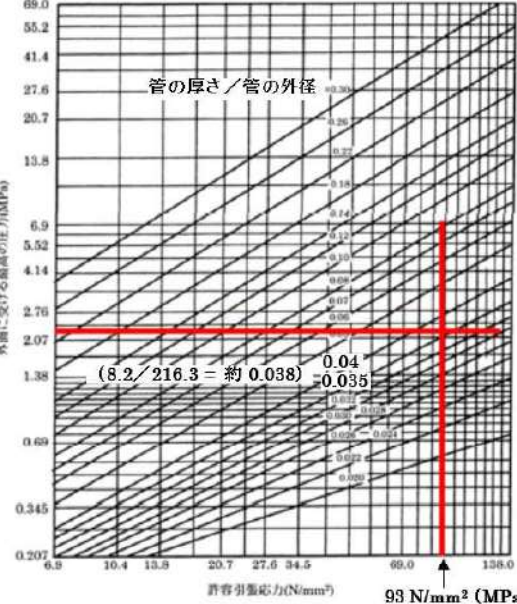
大阪発電所3/4号炉	女川原子力発電所2号炉	泊発電所3号炉	相違理由
	 <p>図1 配管の外圧評価例（日本機械学会「発電用原子力設備規格設計建設規格」（JSME S NC1-2012）PPD-3411(2)より抜粋）</p> <p>（備考）中間の値は、比例法によって計算する。</p>	 <p>図1 配管の外圧評価例（日本機械学会「発電用原子力設備規格設計建設規格」（JSME S NC1-2012）PPD-3411(2)より抜粋）</p> <p>（備考）中間の値は、比例法によって計算する。</p>	<p>【大阪】 記載方針の相違 女川審査実績の反映</p> <p>【女川】 記載方針の相違 泊は、配管の材質から許容引張応力（93MPa）が決まり、管の厚さ/管の外径（8.2/216.3 = 約0.038）の直線と許容引張応力（93MPa）が交わる点のy軸の値が健全性を確保できる最高外圧（2MPa以上）となることを読み取り易くするための情報を記載している。</p>
<p>b. 容器・熱交換器</p> <p>容器及び熱交換器について、機器ごとに個別に構造及び設置の状況、設置区画における溢水の状況に基づき、図面及び現場調査により溢水による機能喪失の可能性について評価を行い、除外する判断が妥当であることを確認した。結果を表1に示す。</p>	<p>b. 容器・熱交換器</p> <p>容器及び熱交換器について、機器ごとに個別に構造及び設置の状況、設置区画における溢水の状況に基づき、図面及び現場調査により溢水による機能喪失の可能性について評価を行い、除外する判断が妥当であることを確認した。結果を表1に示す。</p>	<p>b. 容器・熱交換器</p> <p>容器及び熱交換器について、機器ごとに個別に構造及び設置の状況、設置区画における溢水の状況に基づき、図面及び現場調査により溢水による機能喪失の可能性について評価を行い、除外する判断が妥当であることを確認した。結果を表1に示す。</p>	

赤字：設備、運用又は体制の相違（設計方針の相違）
 青字：記載箇所又は記載内容の相違（記載方針の相違）
 緑字：記載表現、設備名称の相違（実質的な相違なし）

大阪発電所3/4号炉	女川原子力発電所2号炉	泊発電所3号炉	相違理由																																																																																										
	<p>表1 容器・熱交換器に対する溢水による機能喪失の可能性評価 結果(1/6)</p> <table border="1" data-bbox="703 256 1227 1254"> <thead> <tr> <th>防護区画番号</th> <th>機器</th> <th>評価</th> </tr> </thead> <tbody> <tr> <td>R-BIF-1</td> <td>CRDアキムレター CRD窒素容器</td> <td>○当該機器設置区域は床面積が広く浸水深は最大で0.3m以下と低いいため、溢水により機器に機械的損傷が生じることはない。 ○現場調査により、溢水によって機能喪失するようないかなる要因も無いことを確認した。</td> </tr> <tr> <td>R-1F-13, R-1F-16</td> <td>清水膨張タンク 機関付動弁注油タンク 機関付空気冷却器 潤滑油サンプタンク 空気だめ</td> <td>○当該機器の機能が求められる際の区画の浸水深は、同じ区画内に設置されている同区分の非常用ディーゼル発電設備の最も低い機能喪失高さ以下であるため、溢水により機器に機械的損傷が生じることはない。 ○現場調査により、溢水によって機能喪失するようないかなる要因も無いことを確認した。</td> </tr> <tr> <td>R-BIF-7, R-BIF-11</td> <td>清水冷却器 潤滑油冷却器</td> <td>○清水膨張タンクは開放タンクであり上部にベント管があるが、図面及び現場確認により、大気開放箇所が想定する溢水の高さしない位置であることを確認した。また、タンク開放部の高さより、タンク設置区画の最大浸水深が低いことを確認した。 ○当該機器の機能が求められる際の区画の浸水深は、同じ区画内に設置されている同区分の非常用ディーゼル発電設備の最も低い機能喪失高さ以下であるため、溢水により機器に機械的損傷が生じることはない。 ○現場調査により、溢水によって機能喪失するようないかなる要因も無いことを確認した。</td> </tr> </tbody> </table>	防護区画番号	機器	評価	R-BIF-1	CRDアキムレター CRD窒素容器	○当該機器設置区域は床面積が広く浸水深は最大で0.3m以下と低いいため、溢水により機器に機械的損傷が生じることはない。 ○現場調査により、溢水によって機能喪失するようないかなる要因も無いことを確認した。	R-1F-13, R-1F-16	清水膨張タンク 機関付動弁注油タンク 機関付空気冷却器 潤滑油サンプタンク 空気だめ	○当該機器の機能が求められる際の区画の浸水深は、同じ区画内に設置されている同区分の非常用ディーゼル発電設備の最も低い機能喪失高さ以下であるため、溢水により機器に機械的損傷が生じることはない。 ○現場調査により、溢水によって機能喪失するようないかなる要因も無いことを確認した。	R-BIF-7, R-BIF-11	清水冷却器 潤滑油冷却器	○清水膨張タンクは開放タンクであり上部にベント管があるが、図面及び現場確認により、大気開放箇所が想定する溢水の高さしない位置であることを確認した。また、タンク開放部の高さより、タンク設置区画の最大浸水深が低いことを確認した。 ○当該機器の機能が求められる際の区画の浸水深は、同じ区画内に設置されている同区分の非常用ディーゼル発電設備の最も低い機能喪失高さ以下であるため、溢水により機器に機械的損傷が生じることはない。 ○現場調査により、溢水によって機能喪失するようないかなる要因も無いことを確認した。	<p>表1 容器・熱交換器に対する溢水による機能喪失の可能性評価 結果(1/2)</p> <table border="1" data-bbox="1285 280 1854 1190"> <thead> <tr> <th>評価エリア番号</th> <th>機器</th> <th>同一区画内に溢水源となりうる機器・設備のうち、流入防止措置を講じていることにより溢水による影響を受けない。</th> <th>常時監視されていることか、溢水による機械的損傷が生じることはない。</th> <th>コンクリートに埋め込まれているため、溢水により機械的損傷が生じない。</th> <th>溢水により機能喪失するおそれがない。</th> </tr> </thead> <tbody> <tr> <td>34B-F-23</td> <td>ほう殿ばなタンク</td> <td>-</td> <td>○</td> <td>-</td> <td>○</td> </tr> <tr> <td>34B-F-1</td> <td>よう殿湯去集積タンク</td> <td>-</td> <td>○</td> <td>-</td> <td>○</td> </tr> <tr> <td>34B-F-4E</td> <td>原子炉機械冷却ポンプサージタンク</td> <td>-</td> <td>○</td> <td>-</td> <td>○</td> </tr> <tr> <td>34B-F-4E</td> <td>空回機冷却水膨張タンク</td> <td>-</td> <td>○</td> <td>-</td> <td>○</td> </tr> <tr> <td>34B-F-4E</td> <td>A、B-原子炉機械冷却器</td> <td>-</td> <td>○</td> <td>-</td> <td>○</td> </tr> <tr> <td>34B-F-4E</td> <td>C、D-原子炉機械冷却器</td> <td>-</td> <td>○</td> <td>-</td> <td>○</td> </tr> <tr> <td>34B-F-4E</td> <td>機械冷却タンク</td> <td>-</td> <td>○</td> <td>-</td> <td>○</td> </tr> <tr> <td>34B-F-19</td> <td>ほう殿タンク</td> <td>-</td> <td>○</td> <td>-</td> <td>○</td> </tr> <tr> <td>34B-F-1E</td> <td>貯水冷却器</td> <td>-</td> <td>○</td> <td>-</td> <td>○</td> </tr> <tr> <td>34B-F-18</td> <td>B-非常熱除去冷却器</td> <td>-</td> <td>○</td> <td>-</td> <td>○</td> </tr> <tr> <td>34B-F-20</td> <td>A-非常熱除去冷却器</td> <td>-</td> <td>○</td> <td>-</td> <td>○</td> </tr> <tr> <td>34B-F-1E</td> <td>B-燃料容器スプレッド冷却器</td> <td>-</td> <td>○</td> <td>-</td> <td>○</td> </tr> </tbody> </table>	評価エリア番号	機器	同一区画内に溢水源となりうる機器・設備のうち、流入防止措置を講じていることにより溢水による影響を受けない。	常時監視されていることか、溢水による機械的損傷が生じることはない。	コンクリートに埋め込まれているため、溢水により機械的損傷が生じない。	溢水により機能喪失するおそれがない。	34B-F-23	ほう殿ばなタンク	-	○	-	○	34B-F-1	よう殿湯去集積タンク	-	○	-	○	34B-F-4E	原子炉機械冷却ポンプサージタンク	-	○	-	○	34B-F-4E	空回機冷却水膨張タンク	-	○	-	○	34B-F-4E	A、B-原子炉機械冷却器	-	○	-	○	34B-F-4E	C、D-原子炉機械冷却器	-	○	-	○	34B-F-4E	機械冷却タンク	-	○	-	○	34B-F-19	ほう殿タンク	-	○	-	○	34B-F-1E	貯水冷却器	-	○	-	○	34B-F-18	B-非常熱除去冷却器	-	○	-	○	34B-F-20	A-非常熱除去冷却器	-	○	-	○	34B-F-1E	B-燃料容器スプレッド冷却器	-	○	-	○	<p>【大阪】 記載方針の相違 女川審査実績の反映</p> <p>【女川】 記載表現の相違 記載方針の相違 泊では評価結果を横軸とした星取表形式で整理している。評価判定の考え方については女川と泊で相違はない。 設計方針の相違 プラント設計の違いによる相違</p>
防護区画番号	機器	評価																																																																																											
R-BIF-1	CRDアキムレター CRD窒素容器	○当該機器設置区域は床面積が広く浸水深は最大で0.3m以下と低いいため、溢水により機器に機械的損傷が生じることはない。 ○現場調査により、溢水によって機能喪失するようないかなる要因も無いことを確認した。																																																																																											
R-1F-13, R-1F-16	清水膨張タンク 機関付動弁注油タンク 機関付空気冷却器 潤滑油サンプタンク 空気だめ	○当該機器の機能が求められる際の区画の浸水深は、同じ区画内に設置されている同区分の非常用ディーゼル発電設備の最も低い機能喪失高さ以下であるため、溢水により機器に機械的損傷が生じることはない。 ○現場調査により、溢水によって機能喪失するようないかなる要因も無いことを確認した。																																																																																											
R-BIF-7, R-BIF-11	清水冷却器 潤滑油冷却器	○清水膨張タンクは開放タンクであり上部にベント管があるが、図面及び現場確認により、大気開放箇所が想定する溢水の高さしない位置であることを確認した。また、タンク開放部の高さより、タンク設置区画の最大浸水深が低いことを確認した。 ○当該機器の機能が求められる際の区画の浸水深は、同じ区画内に設置されている同区分の非常用ディーゼル発電設備の最も低い機能喪失高さ以下であるため、溢水により機器に機械的損傷が生じることはない。 ○現場調査により、溢水によって機能喪失するようないかなる要因も無いことを確認した。																																																																																											
評価エリア番号	機器	同一区画内に溢水源となりうる機器・設備のうち、流入防止措置を講じていることにより溢水による影響を受けない。	常時監視されていることか、溢水による機械的損傷が生じることはない。	コンクリートに埋め込まれているため、溢水により機械的損傷が生じない。	溢水により機能喪失するおそれがない。																																																																																								
34B-F-23	ほう殿ばなタンク	-	○	-	○																																																																																								
34B-F-1	よう殿湯去集積タンク	-	○	-	○																																																																																								
34B-F-4E	原子炉機械冷却ポンプサージタンク	-	○	-	○																																																																																								
34B-F-4E	空回機冷却水膨張タンク	-	○	-	○																																																																																								
34B-F-4E	A、B-原子炉機械冷却器	-	○	-	○																																																																																								
34B-F-4E	C、D-原子炉機械冷却器	-	○	-	○																																																																																								
34B-F-4E	機械冷却タンク	-	○	-	○																																																																																								
34B-F-19	ほう殿タンク	-	○	-	○																																																																																								
34B-F-1E	貯水冷却器	-	○	-	○																																																																																								
34B-F-18	B-非常熱除去冷却器	-	○	-	○																																																																																								
34B-F-20	A-非常熱除去冷却器	-	○	-	○																																																																																								
34B-F-1E	B-燃料容器スプレッド冷却器	-	○	-	○																																																																																								

赤字：設備、運用又は体制の相違（設計方針の相違）
 青字：記載箇所又は記載内容の相違（記載方針の相違）
 緑字：記載表現、設備名称の相違（実質的な相違なし）

大阪発電所3/4号炉	女川原子力発電所2号炉	泊発電所3号炉	相違理由																																																																														
	<p>表1 容器・熱交換器に対する溢水による機能喪失の可能性評価 結果(2/6)</p> <table border="1"> <thead> <tr> <th data-bbox="703 261 853 767">防範区画番号</th> <th data-bbox="703 772 853 1177">機器</th> <th data-bbox="703 1182 853 1492">評価</th> </tr> </thead> <tbody> <tr> <td data-bbox="703 261 853 336">R-2F-17, R-2F-18, R-2F-19</td> <td data-bbox="703 341 853 767">燃料ダイオキソク</td> <td data-bbox="703 772 853 1492">○当該機器の機能が求められる際の区画の浸水深は、同じ区画内に設置されている同区分のダイオキソク画面計の最も低い機能喪失高さ以下であるため、溢水により機器に機械的損傷が生じることがない。 ○現場調査により、溢水によって機能喪失するようなその他の要因が無いことを確認した。</td> </tr> <tr> <td data-bbox="703 341 853 384">-(軽油タンクピット内)</td> <td data-bbox="703 389 853 767">軽油タンク</td> <td data-bbox="703 772 853 1492">○ピット内には溢水源となりうる機器・配管はなく、また、ピット上部はハッチにより溢水の浸入防止が図られているため、溢水により機器に機械的損傷が生じることがない。 ○現場調査により、溢水によって機能喪失するようなその他の要因が無いことを確認した。</td> </tr> <tr> <td data-bbox="703 389 853 432">R-2F-2-2, R-2F-2-3</td> <td data-bbox="703 437 853 767">FCS 再結合器 FCS 冷却器 FCS 気水分離器</td> <td data-bbox="703 772 853 1492">○当該機器の機能が求められる際の区画の浸水深は、同じ区画内に設置されている同区分の可燃性ガス濃度制御系設備の最も低い機能喪失高さ以下であるため、溢水により機器に機械的損傷が生じることがない。 ○現場調査により、溢水によって機能喪失するようなその他の要因が無いことを確認した。</td> </tr> <tr> <td data-bbox="703 437 853 458">R-3F-1</td> <td data-bbox="703 462 853 767">スキママナージタンク</td> <td data-bbox="703 772 853 1492">○コンクリートへの埋込式タンクであるため溢水により機器の機能が喪失することはない。</td> </tr> <tr> <td data-bbox="703 462 853 483">R-1F-4</td> <td data-bbox="703 488 853 767">燃料プールの冷却浄化系熱交換器</td> <td data-bbox="703 772 853 1492">○当該機器の機能が求められる際の区画の浸水深は最大で0.3m以下と低いいため、溢水により機器に機械的損傷が生じることがない。 ○現場調査により、溢水によって機能喪失するようなその他の要因が無いことを確認した。</td> </tr> </tbody> </table>	防範区画番号	機器	評価	R-2F-17, R-2F-18, R-2F-19	燃料ダイオキソク	○当該機器の機能が求められる際の区画の浸水深は、同じ区画内に設置されている同区分のダイオキソク画面計の最も低い機能喪失高さ以下であるため、溢水により機器に機械的損傷が生じることがない。 ○現場調査により、溢水によって機能喪失するようなその他の要因が無いことを確認した。	-(軽油タンクピット内)	軽油タンク	○ピット内には溢水源となりうる機器・配管はなく、また、ピット上部はハッチにより溢水の浸入防止が図られているため、溢水により機器に機械的損傷が生じることがない。 ○現場調査により、溢水によって機能喪失するようなその他の要因が無いことを確認した。	R-2F-2-2, R-2F-2-3	FCS 再結合器 FCS 冷却器 FCS 気水分離器	○当該機器の機能が求められる際の区画の浸水深は、同じ区画内に設置されている同区分の可燃性ガス濃度制御系設備の最も低い機能喪失高さ以下であるため、溢水により機器に機械的損傷が生じることがない。 ○現場調査により、溢水によって機能喪失するようなその他の要因が無いことを確認した。	R-3F-1	スキママナージタンク	○コンクリートへの埋込式タンクであるため溢水により機器の機能が喪失することはない。	R-1F-4	燃料プールの冷却浄化系熱交換器	○当該機器の機能が求められる際の区画の浸水深は最大で0.3m以下と低いいため、溢水により機器に機械的損傷が生じることがない。 ○現場調査により、溢水によって機能喪失するようなその他の要因が無いことを確認した。	<p>表1 容器・熱交換器に対する溢水による機能喪失の可能性評価 結果(2/2)</p> <table border="1"> <thead> <tr> <th data-bbox="1285 261 1346 384">評価</th> <th data-bbox="1285 389 1346 512">タンク画内部分</th> <th data-bbox="1285 517 1346 639">同一区画内に溢水源となりうる機器・配管は正置を確保していることか</th> <th data-bbox="1285 644 1346 767">常時閉止されていることか</th> <th data-bbox="1285 772 1346 895">コンクリートに埋込式であることか</th> <th data-bbox="1285 900 1346 1023">溢水による機能喪失することはない</th> </tr> </thead> <tbody> <tr> <td data-bbox="1352 261 1413 384">評価エリア番号</td> <td data-bbox="1352 389 1413 512">溢水により高い位置に設置している。</td> <td data-bbox="1352 517 1413 639">-</td> <td data-bbox="1352 644 1413 767">-</td> <td data-bbox="1352 772 1413 895">-</td> <td data-bbox="1352 900 1413 1023">-</td> </tr> <tr> <td data-bbox="1420 261 1480 384">33B-K-22</td> <td data-bbox="1420 389 1480 512">-</td> <td data-bbox="1420 517 1480 639">○</td> <td data-bbox="1420 644 1480 767">○</td> <td data-bbox="1420 772 1480 895">-</td> <td data-bbox="1420 900 1480 1023">○</td> </tr> <tr> <td data-bbox="1487 261 1547 384">33B-K-6</td> <td data-bbox="1487 389 1547 512">A、B-1使用済燃料ピット冷却器</td> <td data-bbox="1487 517 1547 639">-</td> <td data-bbox="1487 644 1547 767">○</td> <td data-bbox="1487 772 1547 895">-</td> <td data-bbox="1487 900 1547 1023">○</td> </tr> <tr> <td data-bbox="1554 261 1615 384">33B-K-1</td> <td data-bbox="1554 389 1615 512">燃料冷却器</td> <td data-bbox="1554 517 1615 639">-</td> <td data-bbox="1554 644 1615 767">○</td> <td data-bbox="1554 772 1615 895">-</td> <td data-bbox="1554 900 1615 1023">○</td> </tr> <tr> <td data-bbox="1621 261 1682 384">33B-F-37</td> <td data-bbox="1621 389 1682 512">A、B-1ディーゼル発電機</td> <td data-bbox="1621 517 1682 639">-</td> <td data-bbox="1621 644 1682 767">○</td> <td data-bbox="1621 772 1682 895">-</td> <td data-bbox="1621 900 1682 1023">○</td> </tr> <tr> <td data-bbox="1688 261 1749 384">33B-F-39</td> <td data-bbox="1688 389 1749 512">燃料油サービスタンク</td> <td data-bbox="1688 517 1749 639">-</td> <td data-bbox="1688 644 1749 767">○</td> <td data-bbox="1688 772 1749 895">-</td> <td data-bbox="1688 900 1749 1023">○</td> </tr> <tr> <td data-bbox="1756 261 1816 384">C/F内</td> <td data-bbox="1756 389 1816 512">西止熱交換器</td> <td data-bbox="1756 517 1816 639">-</td> <td data-bbox="1756 644 1816 767">○</td> <td data-bbox="1756 772 1816 895">-</td> <td data-bbox="1756 900 1816 1023">○</td> </tr> <tr> <td data-bbox="1823 261 1883 384">C/F内</td> <td data-bbox="1823 389 1883 512">蓄圧タンク</td> <td data-bbox="1823 517 1883 639">-</td> <td data-bbox="1823 644 1883 767">○</td> <td data-bbox="1823 772 1883 895">-</td> <td data-bbox="1823 900 1883 1023">○</td> </tr> <tr> <td data-bbox="1890 261 1951 384">屋外</td> <td data-bbox="1890 389 1951 512">ディーゼル発電機燃料油貯油槽</td> <td data-bbox="1890 517 1951 639">-</td> <td data-bbox="1890 644 1951 767">○</td> <td data-bbox="1890 772 1951 895">-</td> <td data-bbox="1890 900 1951 1023">○</td> </tr> </tbody> </table>	評価	タンク画内部分	同一区画内に溢水源となりうる機器・配管は正置を確保していることか	常時閉止されていることか	コンクリートに埋込式であることか	溢水による機能喪失することはない	評価エリア番号	溢水により高い位置に設置している。	-	-	-	-	33B-K-22	-	○	○	-	○	33B-K-6	A、B-1使用済燃料ピット冷却器	-	○	-	○	33B-K-1	燃料冷却器	-	○	-	○	33B-F-37	A、B-1ディーゼル発電機	-	○	-	○	33B-F-39	燃料油サービスタンク	-	○	-	○	C/F内	西止熱交換器	-	○	-	○	C/F内	蓄圧タンク	-	○	-	○	屋外	ディーゼル発電機燃料油貯油槽	-	○	-	○	<p>【大阪】 記載方針の相違 女川審査実績の反映</p> <p>【女川】 記載表現の相違 記載方針の相違 泊では評価結果を横軸とした星取表形式で整理している。評価判定の考え方については女川と泊で相違は無い。 設計方針の相違 プラント設計の違いによる相違</p>
防範区画番号	機器	評価																																																																															
R-2F-17, R-2F-18, R-2F-19	燃料ダイオキソク	○当該機器の機能が求められる際の区画の浸水深は、同じ区画内に設置されている同区分のダイオキソク画面計の最も低い機能喪失高さ以下であるため、溢水により機器に機械的損傷が生じることがない。 ○現場調査により、溢水によって機能喪失するようなその他の要因が無いことを確認した。																																																																															
-(軽油タンクピット内)	軽油タンク	○ピット内には溢水源となりうる機器・配管はなく、また、ピット上部はハッチにより溢水の浸入防止が図られているため、溢水により機器に機械的損傷が生じることがない。 ○現場調査により、溢水によって機能喪失するようなその他の要因が無いことを確認した。																																																																															
R-2F-2-2, R-2F-2-3	FCS 再結合器 FCS 冷却器 FCS 気水分離器	○当該機器の機能が求められる際の区画の浸水深は、同じ区画内に設置されている同区分の可燃性ガス濃度制御系設備の最も低い機能喪失高さ以下であるため、溢水により機器に機械的損傷が生じることがない。 ○現場調査により、溢水によって機能喪失するようなその他の要因が無いことを確認した。																																																																															
R-3F-1	スキママナージタンク	○コンクリートへの埋込式タンクであるため溢水により機器の機能が喪失することはない。																																																																															
R-1F-4	燃料プールの冷却浄化系熱交換器	○当該機器の機能が求められる際の区画の浸水深は最大で0.3m以下と低いいため、溢水により機器に機械的損傷が生じることがない。 ○現場調査により、溢水によって機能喪失するようなその他の要因が無いことを確認した。																																																																															
評価	タンク画内部分	同一区画内に溢水源となりうる機器・配管は正置を確保していることか	常時閉止されていることか	コンクリートに埋込式であることか	溢水による機能喪失することはない																																																																												
評価エリア番号	溢水により高い位置に設置している。	-	-	-	-																																																																												
33B-K-22	-	○	○	-	○																																																																												
33B-K-6	A、B-1使用済燃料ピット冷却器	-	○	-	○																																																																												
33B-K-1	燃料冷却器	-	○	-	○																																																																												
33B-F-37	A、B-1ディーゼル発電機	-	○	-	○																																																																												
33B-F-39	燃料油サービスタンク	-	○	-	○																																																																												
C/F内	西止熱交換器	-	○	-	○																																																																												
C/F内	蓄圧タンク	-	○	-	○																																																																												
屋外	ディーゼル発電機燃料油貯油槽	-	○	-	○																																																																												

赤字：設備、運用又は体制の相違（設計方針の相違）
 青字：記載箇所又は記載内容の相違（記載方針の相違）
 緑字：記載表現、設備名称の相違（実質的な相違なし）

大阪発電所3/4号炉	女川原子力発電所2号炉	泊発電所3号炉	相違理由									
	<p>表1 容器・熱交換器に対する溢水による機能喪失の可能性評価 結果(3/6)</p> <table border="1" data-bbox="705 263 1249 1340"> <thead> <tr> <th data-bbox="705 1181 974 1340">防護区画番号</th> <th data-bbox="705 853 974 1173">機器</th> <th data-bbox="705 263 974 845">評価</th> </tr> </thead> <tbody> <tr> <td data-bbox="981 1181 1249 1340">R-3F-1</td> <td data-bbox="981 853 1249 1173">換気空調補機非常用冷却水系サージタンク</td> <td data-bbox="981 263 1249 845"> ○当該機器設置区域は床面積が広く浸水深は最大で0.3m以下と低いいため、溢水により機器に機械的損傷が生じることはない。 ○現場調査により、溢水によって機能喪失するようなその他の要因が無いことを確認した。 ○換気空調補機非常用冷却水系サージタンクは開放タンクであり上部にベント管があるが、図面及び現場確認により、大気開放箇所が想定する溢水が進入しない位置であることを確認した。また、タンク開放部の高さより、タンク設置区画の最大浸水深が低いことを確認した。 </td> </tr> <tr> <td data-bbox="981 1181 1249 1340">R-1F-15</td> <td data-bbox="981 853 1249 1173">清水膨張タンク 機固付動弁注油タンク 機固付空気冷却器 潤滑油補給タンク 発電機軸受潤滑油冷却器 空気だめ</td> <td data-bbox="981 263 1249 845"> ○当該機器の機能が求められる際の区画の浸水深は、同じ区画内に設置されている同区分の非常用ブイセル発電設備の最も低い機能喪失高さ以下であるため、溢水により機器に機械的損傷が生じることはない。 ○現場調査により、溢水によって機能喪失するようなその他の要因が無いことを確認した。 ○清水膨張タンクは開放タンクであり上部にベント管があるが、図面及び現場確認により、大気開放箇所が想定する溢水が進入しない位置であることを確認した。また、タンク開放部の高さより、タンク設置区画の最大浸水深が低いことを確認した。 </td> </tr> </tbody> </table>	防護区画番号	機器	評価	R-3F-1	換気空調補機非常用冷却水系サージタンク	○当該機器設置区域は床面積が広く浸水深は最大で0.3m以下と低いいため、溢水により機器に機械的損傷が生じることはない。 ○現場調査により、溢水によって機能喪失するようなその他の要因が無いことを確認した。 ○換気空調補機非常用冷却水系サージタンクは開放タンクであり上部にベント管があるが、図面及び現場確認により、大気開放箇所が想定する溢水が進入しない位置であることを確認した。また、タンク開放部の高さより、タンク設置区画の最大浸水深が低いことを確認した。	R-1F-15	清水膨張タンク 機固付動弁注油タンク 機固付空気冷却器 潤滑油補給タンク 発電機軸受潤滑油冷却器 空気だめ	○当該機器の機能が求められる際の区画の浸水深は、同じ区画内に設置されている同区分の非常用ブイセル発電設備の最も低い機能喪失高さ以下であるため、溢水により機器に機械的損傷が生じることはない。 ○現場調査により、溢水によって機能喪失するようなその他の要因が無いことを確認した。 ○清水膨張タンクは開放タンクであり上部にベント管があるが、図面及び現場確認により、大気開放箇所が想定する溢水が進入しない位置であることを確認した。また、タンク開放部の高さより、タンク設置区画の最大浸水深が低いことを確認した。		<p>【大阪】 記載方針の相違 女川審査実績の反映</p> <p>【女川】 記載表現の相違 記載方針の相違 泊では評価結果を横軸とした星取表形式で整理している。評価判定の考え方については女川と泊で相違は無い。 設計方針の相違 プラント設計の違いによる相違</p>
防護区画番号	機器	評価										
R-3F-1	換気空調補機非常用冷却水系サージタンク	○当該機器設置区域は床面積が広く浸水深は最大で0.3m以下と低いいため、溢水により機器に機械的損傷が生じることはない。 ○現場調査により、溢水によって機能喪失するようなその他の要因が無いことを確認した。 ○換気空調補機非常用冷却水系サージタンクは開放タンクであり上部にベント管があるが、図面及び現場確認により、大気開放箇所が想定する溢水が進入しない位置であることを確認した。また、タンク開放部の高さより、タンク設置区画の最大浸水深が低いことを確認した。										
R-1F-15	清水膨張タンク 機固付動弁注油タンク 機固付空気冷却器 潤滑油補給タンク 発電機軸受潤滑油冷却器 空気だめ	○当該機器の機能が求められる際の区画の浸水深は、同じ区画内に設置されている同区分の非常用ブイセル発電設備の最も低い機能喪失高さ以下であるため、溢水により機器に機械的損傷が生じることはない。 ○現場調査により、溢水によって機能喪失するようなその他の要因が無いことを確認した。 ○清水膨張タンクは開放タンクであり上部にベント管があるが、図面及び現場確認により、大気開放箇所が想定する溢水が進入しない位置であることを確認した。また、タンク開放部の高さより、タンク設置区画の最大浸水深が低いことを確認した。										

赤字：設備、運用又は体制の相違（設計方針の相違）
 青字：記載箇所又は記載内容の相違（記載方針の相違）
 緑字：記載表現、設備名称の相違（実質的な相違なし）

大阪発電所3/4号炉	女川原子力発電所2号炉	泊発電所3号炉	相違理由												
	<p>表1 容器・熱交換器に対する溢水による機能喪失の可能性評価 結果(4/6)</p> <table border="1" data-bbox="703 268 1249 1361"> <thead> <tr> <th data-bbox="703 1198 972 1361">防護区画番号</th> <th data-bbox="703 868 972 1193">機器</th> <th data-bbox="703 268 972 863">評価</th> </tr> </thead> <tbody> <tr> <td data-bbox="978 1198 1137 1361">R-2F-3</td> <td data-bbox="978 868 1137 1193">高圧炉心スプレイ補機冷却水サージタンク</td> <td data-bbox="978 268 1137 863">○当該機器設置区域は床面積が広く浸水深は最大で0.3m以下と低いいため、溢水により機器に機械的損傷が生じることはない。 ○現場調査により、溢水によって機能喪失するようなその他の要因が無いことを確認した。</td> </tr> <tr> <td data-bbox="1144 1198 1249 1361">R-B3F-13</td> <td data-bbox="1144 868 1249 1193">高圧炉心スプレイ補機冷却水系熱交換器</td> <td data-bbox="1144 268 1249 863">○高圧炉心スプレイ補機冷却水サージタンクは開放タンクであり上部にベント管があるが、図面及び現場確認により、大気開放箇所が想定する溢水が進入しない位置であることを確認した。また、タンク開放部の高さより、タンク設置区画の最大浸水深が低いことを確認した。</td> </tr> <tr> <td data-bbox="1256 1198 1249 1361">R-M3F-3-1</td> <td data-bbox="1256 868 1249 1193">原子炉棟給気隔離弁用アキュムレータ</td> <td data-bbox="1256 268 1249 863">○当該機器の機能が求められる際の浸水深は、同じ区画内に設置されている同区分の高圧炉心スプレイ補機冷却水系設備の最も低い機能喪失高さ以下であるため、溢水により機器に機械的損傷が生じることはない。 ○現場調査により、溢水によって機能喪失するようなその他の要因が無いことを確認した。</td> </tr> </tbody> </table>	防護区画番号	機器	評価	R-2F-3	高圧炉心スプレイ補機冷却水サージタンク	○当該機器設置区域は床面積が広く浸水深は最大で0.3m以下と低いいため、溢水により機器に機械的損傷が生じることはない。 ○現場調査により、溢水によって機能喪失するようなその他の要因が無いことを確認した。	R-B3F-13	高圧炉心スプレイ補機冷却水系熱交換器	○高圧炉心スプレイ補機冷却水サージタンクは開放タンクであり上部にベント管があるが、図面及び現場確認により、大気開放箇所が想定する溢水が進入しない位置であることを確認した。また、タンク開放部の高さより、タンク設置区画の最大浸水深が低いことを確認した。	R-M3F-3-1	原子炉棟給気隔離弁用アキュムレータ	○当該機器の機能が求められる際の浸水深は、同じ区画内に設置されている同区分の高圧炉心スプレイ補機冷却水系設備の最も低い機能喪失高さ以下であるため、溢水により機器に機械的損傷が生じることはない。 ○現場調査により、溢水によって機能喪失するようなその他の要因が無いことを確認した。		<p>【大阪】 記載方針の相違 女川審査実績の反映</p> <p>【女川】 記載表現の相違 記載方針の相違 泊では評価結果を横軸とした星取表形式で整理している。評価判定の考え方については女川と泊で相違は無い。 設計方針の相違 プラント設計の違いによる相違</p>
防護区画番号	機器	評価													
R-2F-3	高圧炉心スプレイ補機冷却水サージタンク	○当該機器設置区域は床面積が広く浸水深は最大で0.3m以下と低いいため、溢水により機器に機械的損傷が生じることはない。 ○現場調査により、溢水によって機能喪失するようなその他の要因が無いことを確認した。													
R-B3F-13	高圧炉心スプレイ補機冷却水系熱交換器	○高圧炉心スプレイ補機冷却水サージタンクは開放タンクであり上部にベント管があるが、図面及び現場確認により、大気開放箇所が想定する溢水が進入しない位置であることを確認した。また、タンク開放部の高さより、タンク設置区画の最大浸水深が低いことを確認した。													
R-M3F-3-1	原子炉棟給気隔離弁用アキュムレータ	○当該機器の機能が求められる際の浸水深は、同じ区画内に設置されている同区分の高圧炉心スプレイ補機冷却水系設備の最も低い機能喪失高さ以下であるため、溢水により機器に機械的損傷が生じることはない。 ○現場調査により、溢水によって機能喪失するようなその他の要因が無いことを確認した。													

赤字：設備、運用又は体制の相違（設計方針の相違）
 青字：記載箇所又は記載内容の相違（記載方針の相違）
 緑字：記載表現、設備名称の相違（実質的な相違なし）

大阪発電所3/4号炉	女川原子力発電所2号炉	泊発電所3号炉	相違理由								
	<p>表1 容器・熱交換器に対する溢水による機能喪失の可能性評価 結果(5/6)</p> <table border="1"> <thead> <tr> <th data-bbox="703 255 741 869">評価</th> <th data-bbox="703 874 741 1380">機器</th> </tr> </thead> <tbody> <tr> <td data-bbox="748 255 896 869"> ○常時蓄圧されていることから、溢水により機械的損傷が生じることはない。 ○現場調査により、溢水によって機能喪失するようないかなる他の要因が無いかを確認した。 </td> <td data-bbox="748 874 896 1380"> 主蒸気逃し安全弁遮断機能用アキユムレータ 主蒸気逃し安全弁アキユムレータ(ADS) 主蒸気第一隔離弁用アキユムレータ </td> </tr> <tr> <td data-bbox="902 255 1008 869"> ○常時蓄圧されていない。 ○現場調査により、溢水によって機能喪失するようないかなる他の要因が無いかを確認した。 </td> <td data-bbox="902 874 1008 1380"> 主蒸気第二隔離弁用アキユムレータ </td> </tr> <tr> <td data-bbox="1014 255 1272 869"> ○当該機器設置区域は床面積が広く浸水深は最大で0.3m以下と低いいため、溢水により機械的損傷が生じることはない。 ○現場調査により、溢水によって機能喪失するようないかなる他の要因が無いかを確認した。 ○原子炉補機冷却水サージタンクは開放タンクであり上部にベント管があるが、図面及び現場確認により、大気開放箇所が想定する溢水が進まない位置であることを確認した。また、タンク開放部の高さより、タンク設置区画の最大浸水深が低いことを確認した。 </td> <td data-bbox="1014 874 1272 1380"> 原子炉補機冷却水サージタンク </td> </tr> </tbody> </table>	評価	機器	○常時蓄圧されていることから、溢水により機械的損傷が生じることはない。 ○現場調査により、溢水によって機能喪失するようないかなる他の要因が無いかを確認した。	主蒸気逃し安全弁遮断機能用アキユムレータ 主蒸気逃し安全弁アキユムレータ(ADS) 主蒸気第一隔離弁用アキユムレータ	○常時蓄圧されていない。 ○現場調査により、溢水によって機能喪失するようないかなる他の要因が無いかを確認した。	主蒸気第二隔離弁用アキユムレータ	○当該機器設置区域は床面積が広く浸水深は最大で0.3m以下と低いいため、溢水により機械的損傷が生じることはない。 ○現場調査により、溢水によって機能喪失するようないかなる他の要因が無いかを確認した。 ○原子炉補機冷却水サージタンクは開放タンクであり上部にベント管があるが、図面及び現場確認により、大気開放箇所が想定する溢水が進まない位置であることを確認した。また、タンク開放部の高さより、タンク設置区画の最大浸水深が低いことを確認した。	原子炉補機冷却水サージタンク		<p>【大阪】 記載方針の相違 女川審査実績の反映</p> <p>【女川】 記載表現の相違 記載方針の相違 泊では評価結果を横軸とした星取表形式で整理している。評価判定の考え方については女川と泊で相違は無い。 設計方針の相違 プラント設計の違いによる相違</p>
評価	機器										
○常時蓄圧されていることから、溢水により機械的損傷が生じることはない。 ○現場調査により、溢水によって機能喪失するようないかなる他の要因が無いかを確認した。	主蒸気逃し安全弁遮断機能用アキユムレータ 主蒸気逃し安全弁アキユムレータ(ADS) 主蒸気第一隔離弁用アキユムレータ										
○常時蓄圧されていない。 ○現場調査により、溢水によって機能喪失するようないかなる他の要因が無いかを確認した。	主蒸気第二隔離弁用アキユムレータ										
○当該機器設置区域は床面積が広く浸水深は最大で0.3m以下と低いいため、溢水により機械的損傷が生じることはない。 ○現場調査により、溢水によって機能喪失するようないかなる他の要因が無いかを確認した。 ○原子炉補機冷却水サージタンクは開放タンクであり上部にベント管があるが、図面及び現場確認により、大気開放箇所が想定する溢水が進まない位置であることを確認した。また、タンク開放部の高さより、タンク設置区画の最大浸水深が低いことを確認した。	原子炉補機冷却水サージタンク										

赤字：設備、運用又は体制の相違（設計方針の相違）
 青字：記載箇所又は記載内容の相違（記載方針の相違）
 緑字：記載表現、設備名称の相違（実質的な相違なし）

大阪発電所3/4号炉	女川原子力発電所2号炉	泊発電所3号炉	相違理由												
	<p>表1 容器・熱交換器に対する溢水による機能喪失の可能性評価 結果(6/6)</p> <table border="1" data-bbox="696 264 1272 1209"> <thead> <tr> <th data-bbox="696 1070 864 1209">防護区画番号</th> <th data-bbox="696 786 864 1070">機器</th> <th data-bbox="696 264 864 786">評価</th> </tr> </thead> <tbody> <tr> <td data-bbox="696 1070 864 1209">R-B3F-11, R-B3F-14</td> <td data-bbox="696 786 864 1070">原子炉補機冷却水系熱交換器</td> <td data-bbox="696 264 864 786">○当該機器の機能が求められる際の区画の浸水深は、同じ区画内に設置されている同区分の原子炉補機冷却水系設備の最も低い機能喪失高さ以下であるため、溢水により機器に機械的損傷が生じることがない。 ○現場調査により、溢水によって機能喪失するようなその他の要因が無いことを確認した。</td> </tr> <tr> <td data-bbox="864 1070 1003 1209">R-1F-1, R-1F-11</td> <td data-bbox="864 786 1003 1070">残留熱除去系熱交換器</td> <td data-bbox="864 264 1003 786">○当該機器の機能が求められる際の区画の浸水深は、同じ区画内に設置されている同区分の残留熱除去系設備の最も低い機能喪失高さ以下であるため、溢水により機器に機械的損傷が生じることがない。 ○現場調査により、溢水によって機能喪失するようなその他の要因が無いことを確認した。</td> </tr> <tr> <td data-bbox="1003 1070 1272 1209">R-2F-3-1</td> <td data-bbox="1003 786 1272 1070">ほう酸水注入系貯蔵タンク ほう酸水注入系アキュムレータ</td> <td data-bbox="1003 264 1272 786">○当該機器の機能が求められる際の区画の浸水深は、同じ区画内に設置されているほう酸水注入系設備の最も低い機能喪失高さ以下であるため、溢水により機器に機械的損傷が生じることがない。 ○現場調査により、溢水によって機能喪失するようなその他の要因が無いことを確認した。 ○ほう酸水注入系貯蔵タンクは開放タンクであり上部にベント管があるが、図面及び現場確認により、大気開放箇所が想定する溢水が進入しない位置であることを確認した。また、タンク開放部の高さより、タンク設置区画の最大浸水深が低いことを確認した。</td> </tr> </tbody> </table>	防護区画番号	機器	評価	R-B3F-11, R-B3F-14	原子炉補機冷却水系熱交換器	○当該機器の機能が求められる際の区画の浸水深は、同じ区画内に設置されている同区分の原子炉補機冷却水系設備の最も低い機能喪失高さ以下であるため、溢水により機器に機械的損傷が生じることがない。 ○現場調査により、溢水によって機能喪失するようなその他の要因が無いことを確認した。	R-1F-1, R-1F-11	残留熱除去系熱交換器	○当該機器の機能が求められる際の区画の浸水深は、同じ区画内に設置されている同区分の残留熱除去系設備の最も低い機能喪失高さ以下であるため、溢水により機器に機械的損傷が生じることがない。 ○現場調査により、溢水によって機能喪失するようなその他の要因が無いことを確認した。	R-2F-3-1	ほう酸水注入系貯蔵タンク ほう酸水注入系アキュムレータ	○当該機器の機能が求められる際の区画の浸水深は、同じ区画内に設置されているほう酸水注入系設備の最も低い機能喪失高さ以下であるため、溢水により機器に機械的損傷が生じることがない。 ○現場調査により、溢水によって機能喪失するようなその他の要因が無いことを確認した。 ○ほう酸水注入系貯蔵タンクは開放タンクであり上部にベント管があるが、図面及び現場確認により、大気開放箇所が想定する溢水が進入しない位置であることを確認した。また、タンク開放部の高さより、タンク設置区画の最大浸水深が低いことを確認した。		<p>【大阪】 記載方針の相違 女川審査実績の反映</p> <p>【女川】 記載表現の相違 記載方針の相違 泊では評価結果を横軸とした星取表形式で整理している。評価判定の考え方については女川と泊で相違は無い。 設計方針の相違 プラント設計の違いによる相違</p>
防護区画番号	機器	評価													
R-B3F-11, R-B3F-14	原子炉補機冷却水系熱交換器	○当該機器の機能が求められる際の区画の浸水深は、同じ区画内に設置されている同区分の原子炉補機冷却水系設備の最も低い機能喪失高さ以下であるため、溢水により機器に機械的損傷が生じることがない。 ○現場調査により、溢水によって機能喪失するようなその他の要因が無いことを確認した。													
R-1F-1, R-1F-11	残留熱除去系熱交換器	○当該機器の機能が求められる際の区画の浸水深は、同じ区画内に設置されている同区分の残留熱除去系設備の最も低い機能喪失高さ以下であるため、溢水により機器に機械的損傷が生じることがない。 ○現場調査により、溢水によって機能喪失するようなその他の要因が無いことを確認した。													
R-2F-3-1	ほう酸水注入系貯蔵タンク ほう酸水注入系アキュムレータ	○当該機器の機能が求められる際の区画の浸水深は、同じ区画内に設置されているほう酸水注入系設備の最も低い機能喪失高さ以下であるため、溢水により機器に機械的損傷が生じることがない。 ○現場調査により、溢水によって機能喪失するようなその他の要因が無いことを確認した。 ○ほう酸水注入系貯蔵タンクは開放タンクであり上部にベント管があるが、図面及び現場確認により、大気開放箇所が想定する溢水が進入しない位置であることを確認した。また、タンク開放部の高さより、タンク設置区画の最大浸水深が低いことを確認した。													

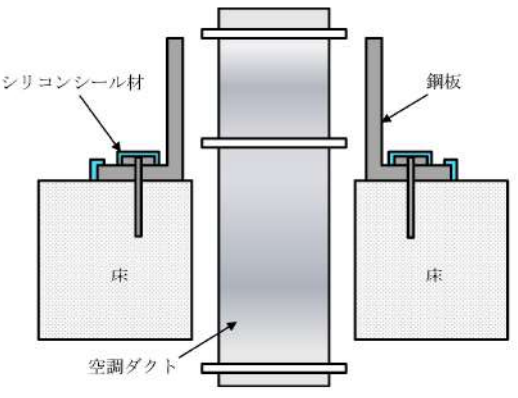
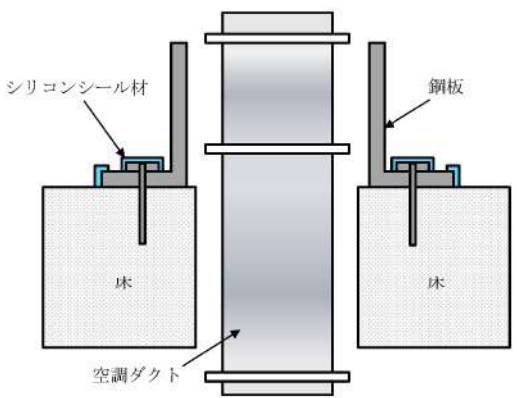

赤字：設備、運用又は体制の相違（設計方針の相違）
 青字：記載箇所又は記載内容の相違（記載方針の相違）
 緑字：記載表現、設備名称の相違（実質的な相違なし）

大阪発電所3/4号炉	女川原子力発電所2号炉	泊発電所3号炉	相違理由
	<p>c. ダクト</p> <p>換気空調系のダクトは構造部材ではないことから、水圧に対して機械的損傷が否定できないダクトについては図2に例示するような対策を講ずることとする。</p> <p>なお、例示のように、床を貫通するダクトに対して堰等の防護対策を施す場合には、現場調査の結果に基づき溢水の滴下による堰内への水の流入の可能性を検討し、必要に応じて流入防止のための配慮を行う。</p>  <p>図2 ダクトに対する溢水対策</p>	<p>c. ダクト</p> <p>換気空調系のダクトは構造部材ではないことから、水圧に対して機械的損傷が否定できないダクトについては図2に例示するような対策を講ずることとする。</p> <p>なお、例示のように、床を貫通するダクトに対して堰等の防護対策を施す場合には、現場調査の結果に基づき溢水の滴下による堰内への水の流入の可能性を検討し、必要に応じて流入防止のための配慮を行う。</p>  <p>図2 ダクトに対する溢水対策</p>	<p>【大阪】</p> <p>記載方針の相違</p> <p>女川審査実績の反映</p>

赤字：設備、運用又は体制の相違（設計方針の相違）
 青字：記載箇所又は記載内容の相違（記載方針の相違）
 緑字：記載表現、設備名称の相違（実質的な相違なし）

大阪発電所3/4号炉	女川原子力発電所2号炉	泊発電所3号炉	相違理由
<p>(4-2 原子炉格納容器内防護対象設備の溢水影響について より抜粋)</p> <p>3. 原子炉格納容器内防護対象設備の溢水影響評価について 耐環境性仕様である原子炉格納容器内防護対象設備については、LOCA時の原子炉格納容器内環境に対して機能維持が図れるよう、以下のことを確認している。確認結果の一覧は別表に示す。</p> <p>(1)被水影響 LOCAに伴い原子炉格納容器内圧力が上昇すると、格納容器スプレイが動作し、スプレイ水により防護対象設備が被水する。原子炉格納容器内防護対象設備は、スプレイ水に対しても機能維持が図れることを、1. に述べた環境試験により確認している。</p> <p>(2)没水影響 LOCAに伴う炉心注入及び格納容器スプレイにより、燃料取替用水ピット及び蓄圧タンクの保有水が原子炉格納容器内に注水される。LOCA時に機能要求のある防護対象設備は、1次冷却系の漏えい水の他、これらの保有水全量が原子炉格納容器内にたまった場合においても、没水しない高さに設置している。</p>	<p>(2)②「PCV内耐環境仕様の設備」について 原子炉格納容器内設備のうち、重要度の特に高い安全機能を有する系統設備は、以下に示すように、設計基準事故において最も環境が苛酷な原子炉冷却材喪失事故時の原子炉格納容器内の状態（温度・圧力条件及び溢水影響）を考慮した耐環境仕様で設計（設計条件、圧力0.427MPa[gage]、温度：171℃、湿度：100%（蒸気））されているため、溢水影響評価において対象外としている。</p> <p>a. 被水による影響評価 設計基準事故時にドライウエル内が蒸気で満たされた場合、格納容器スプレイの蒸気凝縮効果によって原子炉格納容器を効果的に減圧することができる。格納容器スプレイ水はドライウエル内に一様に噴霧されるため、事故時に動作が必要となる設備については格納容器スプレイ時（被水時）にもその動作が保障されなければならない。そのため原子炉格納容器内に設置されており、事故時に動作が必要となる設備は、設計基準事故時の雰囲気下で機能維持が図れるよう設計及び試験を行っている。</p> <p>b. 没水影響評価 原子炉冷却材喪失事故時に原子炉格納容器内に発生する破断口からの溢水、及び格納容器スプレイ水は、原子炉格納容器内のドライウエル下部に溜まった後、ドライウエル下部にあるベント管を通り、サブプレッションチェンバへ流れ込む設計となっている。 高圧炉心スプレイ系の初期水源は復水貯蔵タンクであるが、サブプレッションチェンバ水位高（0.P.-3800）又は復水貯蔵タンク水位低で、水源はサブプレッションチェンバに切り替わることから、原子炉冷却材喪失事故時にサブプレッションチェンバ水位高（0.P.-3800）よりも高水位まで原子炉格納容器が溢水することは無い。 原子炉格納容器内の防護対象設備は上述したサブプレッションチェンバ水位高（0.P.-3800）以上の高さに設置されていることから、没水により機能喪失することはない。</p>	<p>(2)②「原子炉格納容器内耐環境仕様の設備」について 原子炉格納容器内設備のうち、重要度の特に高い安全機能を有する系統設備は、以下に示すように、設計基準事故において最も環境が苛酷な原子炉冷却材喪失事故時の原子炉格納容器内の状態（温度・圧力条件及び溢水影響）を考慮した耐環境仕様で設計（設計条件、圧力0.283MPa [gage]、温度：132℃、湿度：100%（蒸気））されているため、溢水影響評価において対象外としている。</p> <p>a. 被水による影響評価 設計基準事故時に原子炉格納容器内が蒸気で満たされた場合、格納容器スプレイの蒸気凝縮効果によって原子炉格納容器を効果的に減圧することができる。格納容器スプレイ水は原子炉格納容器内に一様に噴霧されるため、事故時に動作が必要となる設備については格納容器スプレイ時（被水時）にもその動作が保障されなければならない。そのため原子炉格納容器内に設置されており、事故時に動作が必要となる設備は、設計基準事故時の雰囲気下で機能維持が図れるよう設計及び試験を行っている。</p> <p>b. 没水影響評価 原子炉冷却材喪失事故時に原子炉格納容器内に発生する破断口からの溢水、及び格納容器スプレイ水は、原子炉格納容器最下階まで流下した後、原子炉格納容器再循環サンプへ流れ込む設計となっている。 原子炉冷却材喪失事故に伴う炉心注入及び原子炉格納容器スプレイにより、燃料取替用水ピット及び蓄圧タンクの保有水が原子炉格納容器内に注水され、燃料取替用水ピット水位低となり、原子炉格納容器再循環に切り替わる。 原子炉冷却材喪失事故による漏えい水も含めた水の全量が格納容器内に溜まった場合の水位はT.P.15.1mであり、原子炉格納容器内の防護対象設備はT.P.15.1mより高い位置に設置されていることから、没水により機能喪失することはない。</p>	<p>【女川】 設備名称の相違</p> <p>【大阪】 記載方針の相違</p> <p>女川審査実績の反映</p> <p>【女川】 設計方針の相違</p> <p>プラント設計の相違により、原子炉格納容器内の温度・圧力条件が異なる。</p> <p>【女川】 設備名称の相違</p> <p>【大阪】 記載表現の相違 記載方針の相違</p> <p>女川審査実績の反映</p> <p>【女川】 記載表現の相違 設計方針の相違</p> <p>PWRとBWRの原子炉格納容器の設計の相違により、原子炉格納容器内で発生する溢水水位の算出過程は異なるが、原子炉格納容器内の防護対象設備が溢水水位以上の高さに設置されており、没水によって機能喪失しない評価としていることに相違はない。</p> <p>【大阪】 記載方針の相違</p> <p>女川審査実績の反映</p> <p>原子炉格納容器内の防護対象設備を没水しない高さに設置しているのは泊と大阪で同じ。</p>

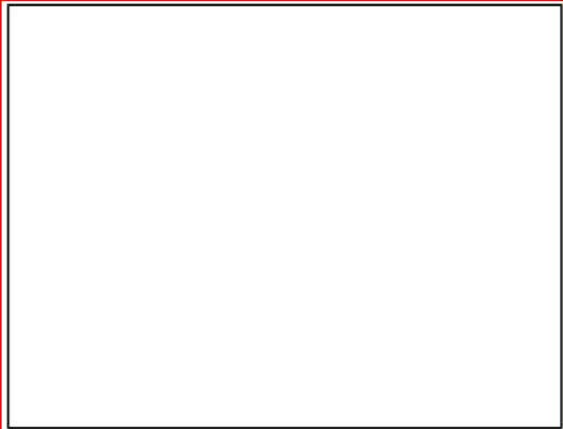
赤字：設備、運用又は体制の相違（設計方針の相違）
 青字：記載箇所又は記載内容の相違（記載方針の相違）
 緑字：記載表現、設備名称の相違（実質的な相違なし）

大阪発電所3/4号炉	女川原子力発電所2号炉	泊発電所3号炉	相違理由
<p>(3)蒸気影響</p> <p>LOCAに伴い原子炉格納容器内には蒸気が充満する。原子炉格納容器内防護対象設備は、蒸気環境下においても機能維持が図れることを、1. に述べた環境試験により確認している。</p> <p>【伊方3号炉】まとめ資料 添付資料1 9条-別添1-添1-28より抜粋</p> <p>3. 蒸気影響評価</p> <p>LOCAに伴ってフラッシュ蒸発した1次冷却材の蒸気により、C/V内は全域が高温・高圧の蒸気雰囲気となる。</p> <p>C/V内防護対象設備は、安全解析で求められた高温・高圧環境に対して機能維持が図れるよう、設計および試験を実施している。</p>  <p>図-2 LOCA時のC/V内温度、圧力変化（環境条件）</p>	<p>c. 蒸気影響評価</p> <p>原子炉冷却材喪失事故に伴ってフラッシュ蒸発した原子炉冷却材の蒸気により、原子炉格納容器内は全域が高温・高圧の蒸気雰囲気となる。</p> <p>原子炉冷却材喪失事故時に機能要求がある原子炉格納容器内防護対象設備は、安全解析で求められた高温・高圧環境に対して機能維持が図れるよう設計及び試験を行っている。</p> <p>被水及び蒸気影響を確認した確認試験は、原子炉格納容器内での再循環配管破断及び主蒸気配管破断時の環境（図3、図4参照）を包絡した条件で行っている。図5に試験条件の代表例を示す。</p>  <p>図3 原子炉格納容器圧力変化（再循環配管破断）</p>  <p>図4 原子炉格納容器温度変化（主蒸気配管破断）</p> <p>枠囲みの内容は商業機密の観点から公開できません。</p>	<p>c. 蒸気影響評価</p> <p>原子炉冷却材喪失事故に伴ってフラッシュ蒸発した原子炉冷却材の蒸気により、原子炉格納容器内は全域が高温・高圧の蒸気雰囲気となる。</p> <p>原子炉冷却材喪失事故時に機能要求がある原子炉格納容器内防護対象設備は、安全解析で求められた高温・高圧環境に対して機能維持が図れるよう設計及び試験を行っている。</p> <p>被水及び蒸気影響を確認した確認試験は、原子炉格納容器内での原子炉冷却材喪失事故時の環境条件（図3参照）で行っている。図4に試験条件の代表例を示す。</p>  <p>図3 原子炉格納容器圧力変化（原子炉冷却材喪失事故時）</p> <p>枠囲みの内容は機密情報に属しますので公開できません。</p>	<p>【大阪】</p> <p>記載方針の相違</p> <p>女川審査実績の反映</p> <p>【女川】</p> <p>設計方針の相違</p> <p>PWRとBWRの原子炉格納容器の設計の相違により、泊は原子炉格納容器内環境条件が最も厳しくなるLOCA時の環境条件として試験を行っている。</p> <p>記載表現の相違</p> <p>【女川】</p> <p>記載方針の相違</p> <p>PWRとBWRの原子炉格納容器の設計の相違により、泊は原子炉格納容器内環境条件が最も厳しくなるLOCA時の環境条件として試験を行っている。（伊方と同様）</p> <p>記載表現の相違</p> <p>【伊方】</p> <p>設計方針の相違</p> <p>プラント設計の相違</p>

赤字：設備、運用又は体制の相違（設計方針の相違）
 青字：記載箇所又は記載内容の相違（記載方針の相違）
 緑字：記載表現、設備名称の相違（実質的な相違なし）

第9条 溢水による損傷の防止等（別添1添付資料6）

大阪発電所3/4号炉	女川原子力発電所2号炉	泊発電所3号炉	相違理由															
<p>4-3 原子炉格納容器内機器の耐環境性試験におけるスプレイ条件について</p> <p>1. 耐環境性試験の試験条件の考え方</p> <p>原則として、米国の民間規格 IEEE-323 を参考に、実機条件及び試験装置条件を考慮して設定する。</p> <p>なお、格納容器スプレイによる被水については、機器のシール性能が確認できれば機能への影響はないものと判断している。</p> <p>表1 実機条件と試験条件の比較</p> <table border="1" data-bbox="129 486 683 638"> <thead> <tr> <th></th> <th>試験条件 (伝送器の例)</th> <th>実機条件 (大阪3号炉、及び4号炉)</th> <th>実機条件 (高浜3号炉、及び4号炉)</th> <th>IEEE-323</th> </tr> </thead> <tbody> <tr> <td>スプレイ 流量</td> <td>63.7 [L/min/m²]</td> <td>13.8 [L/min/m²]</td> <td>12.5 [L/min/m²]</td> <td>6.1 [L/min/m²]</td> </tr> <tr> <td>スプレイ 時間</td> <td>24[h]</td> <td>24[h]以上</td> <td>24[h]以上</td> <td>24[γ]</td> </tr> </tbody> </table> <p>2. スプレイ条件の保守性に関する考察</p> <p>格納容器スプレイは下図のとおり、LOCA後の環境温度、圧力が高い条件で24時間実施している。</p> <p>この条件でシール性能に問題のないことを確認できれば、温度、圧力が低下した24時間以降のシール性能についても問題はないと考えられ、IEEE-323にしたがったスプレイ条件は試験条件として妥当と判断している。</p>  <p>図1 耐環境性試験プロファイル</p> <p>枠囲みの範囲は機密に係る事項ですので公開することはできません。</p>		試験条件 (伝送器の例)	実機条件 (大阪3号炉、及び4号炉)	実機条件 (高浜3号炉、及び4号炉)	IEEE-323	スプレイ 流量	63.7 [L/min/m ²]	13.8 [L/min/m ²]	12.5 [L/min/m ²]	6.1 [L/min/m ²]	スプレイ 時間	24[h]	24[h]以上	24[h]以上	24[γ]	<p>原子炉格納容器内環境適合性の確認例</p>  <p>図5 耐環境性試験条件（代表例）</p> <p>枠囲みの内容は商業機密の観点から公開できません。</p>	<p>原子炉格納容器内環境適合性の確認例</p>  <p>図4 耐環境性試験条件（代表例）</p> <p>枠囲みの内容は機密情報に属しますので公開できません。</p>	<p>相違理由</p> <p>【大阪】 記載方針の相違 女川審査実績の反映</p> <p>【女川】 設計方針の相違 プラント設計の相違 記載表現の相違</p>
	試験条件 (伝送器の例)	実機条件 (大阪3号炉、及び4号炉)	実機条件 (高浜3号炉、及び4号炉)	IEEE-323														
スプレイ 流量	63.7 [L/min/m ²]	13.8 [L/min/m ²]	12.5 [L/min/m ²]	6.1 [L/min/m ²]														
スプレイ 時間	24[h]	24[h]以上	24[h]以上	24[γ]														

赤字：設備、運用又は体制の相違（設計方針の相違）
 青字：記載箇所又は記載内容の相違（記載方針の相違）
 緑字：記載表現、設備名称の相違（実質的な相違なし）

大阪発電所3/4号炉	女川原子力発電所2号炉	泊発電所3号炉	相違理由
	<p>(3) ③「動作機能の喪失により安全機能に影響しない」について</p> <p>フェイル・セイフ機能により溢水影響評価対象外とした設備は空気作動のもの(A0)と電磁石によるもの(S0)に分類される。次項以降でそれぞれその構造を示す。</p> <p>なお、これらの溢水影響評価対象外とした設備については、フェイル動作後には動作要求がないことを確認した。</p> <p>a. 電磁弁(S0)への影響</p> <p>代表例として移動式炉心内校正装置パージ隔離弁の動作概要を図6に示す。当該隔離弁を開動作させる場合は電磁石を励磁させる。これにより弁閉状態を維持するばね力に打ち勝って鉄心が電磁石に吸着し、弁開となり、またその状態を保持する。溢水によって当該隔離弁の動作機能が喪失した（電磁石が非励磁になった）場合、ばね力により鉄心は電磁石から離れて弁閉になり、また閉状態が維持される。当該弁に要求される安全機能は閉じ込め機能であることから、溢水により当該弁の動作機能が喪失した場合においても安全機能に影響はない。</p> <div data-bbox="728 938 1232 1308"> <p>弁“開”状態図 電磁石が励磁すると、鉄心が電磁石に吸着し、弁体が押し下られて、弁体はシート部より離れる。このときばねは伸ばされ、常に弁「閉」側にばね力が加わった状態となる。</p> <p>弁“閉”状態図 電磁石が非励磁となると、鉄心は電磁石から吸放され、ばねが縮みばね力にて弁体がシート部に密着する。</p> </div> <p>図6 移動式炉心内校正装置パージ隔離弁の動作概要図</p>	<p>(3) ③「動作機能の喪失により安全機能に影響しない」について</p> <p>フェイル・セイフ機能により溢水影響評価対象外とした空気作動弁(A0V)について、次項以降でその構造を示す。</p> <p>なお、これらの溢水影響評価対象外とした設備については、フェイル動作後には動作要求がないことを確認した。</p>	<p>【大阪】 記載方針の相違 女川審査実績の反映</p> <p>【女川】 記載表現の相違 設計方針の相違 泊では溢水評価対象外とした電磁弁は無い。</p> <p>【女川】 設計方針の相違 泊では溢水評価対象外とした電磁弁は無い。</p>

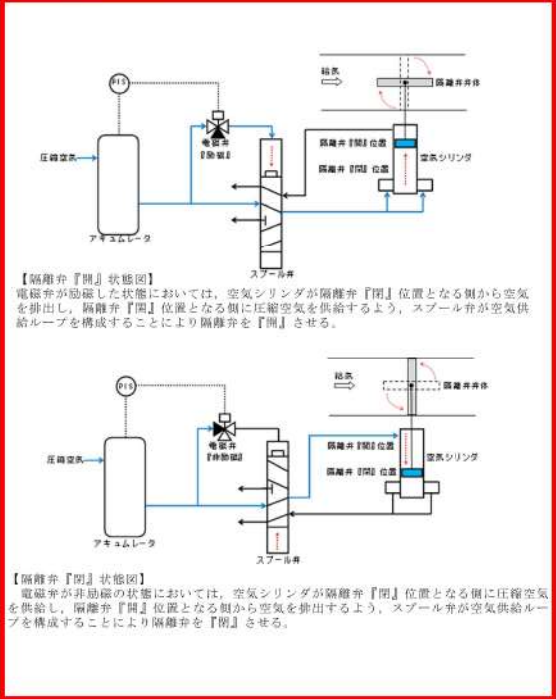
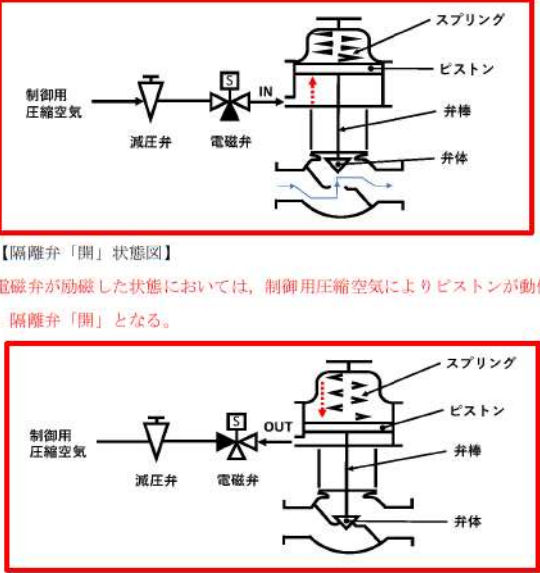
大阪発電所3/4号炉	女川原子力発電所2号炉	泊発電所3号炉	相違理由
	<p>b. 空気作動弁（AO）への影響</p> <p>代表例として原子炉棟給気隔離弁の動作概要を図7に示す。当該隔離弁を開動作させる場合は、電磁弁を励磁させ、圧縮空気によりスプール弁を動作させる。これにより圧縮空気供給ループの構成が変化して隔離弁開となり、また開状態が保持される。溢水によって当該弁の動作機能が喪失した（電磁弁が非励磁となった）場合、スプール弁は通常位置に復帰する。これにより圧縮空気供給ループが変化し、隔離弁閉となり、また閉状態が維持される。当該弁に要求される安全機能は閉じ込め機能であることから、溢水により当該弁の動作機能が喪失した場合においても安全機能に影響はない。</p>  <p>【隔離弁『開』状態図】 電磁弁が励磁した状態においては、空気シリンダが隔離弁『開』位置となる側から空気を排出し、隔離弁『開』位置となる側に圧縮空気を供給するよう、スプール弁が空気供給ループを構成することにより隔離弁を『開』させる。</p> <p>【隔離弁『閉』状態図】 電磁弁が非励磁の状態においては、空気シリンダが隔離弁『閉』位置となる側に圧縮空気を供給し、隔離弁『開』位置となる側から空気を排出するよう、スプール弁が空気供給ループを構成することにより隔離弁を『閉』させる。</p> <p>図7 原子炉棟給気隔離弁の動作概要図</p>	<p>a. 空気作動弁（AOV）への影響</p> <p>フェイルポジションが「閉」である空気作動弁（隔離弁）の動作概要を図5に示す。当該隔離弁を開動作させる場合は、電磁弁を励磁させ、制御用圧縮空気によりピストンを動作させる。これにより隔離弁開となり、また開状態が保持される。溢水によって当該弁の動作機能が喪失した（電磁弁が非励磁となった）場合、ピストンは通常位置に復帰する。これにより隔離弁閉となり、また閉状態が維持される。隔離弁に要求される安全機能は閉じ込め機能であることから、溢水により当該弁の動作機能が喪失した場合においても安全機能に影響はない。</p>  <p>【隔離弁『開』状態図】 電磁弁が励磁した状態においては、制御用圧縮空気によりピストンが動作し、隔離弁『開』となる。</p> <p>【隔離弁『閉』状態図】 電磁弁が非励磁の状態においては、ピストンは通常位置に復帰し、隔離弁『閉』となる。</p> <p>図5 空気作動弁（隔離弁）の動作概要図</p>	<p>【大阪】 記載方針の相違 女川審査実績の反映</p> <p>【女川】 記載表現の相違 記載方針の相違 泊は具体的な弁を代表例としてあげるのではなく、空気作動弁（隔離弁）の共通的な動作概要として記載している。</p> <p>【女川】 設計方針の相違 隔離弁の構造の相違により、記載が異なる。</p> <p>【女川】 記載表現の相違</p>

赤字：設備、運用又は体制の相違（設計方針の相違）
 青字：記載箇所又は記載内容の相違（記載方針の相違）
 緑字：記載表現、設備名称の相違（実質的な相違なし）

大阪発電所3/4号炉	女川原子力発電所2号炉	泊発電所3号炉	相違理由
	<p>c. 没水によるフェイル・セーフ動作への影響</p> <p>以下に示すとおり、没水によりフェイル・セーフ機能への影響はないと考える。</p> <p>(a) 基本的には端子箱が没水した時点で電源が遮断され、電磁弁が作動し、弁のフェイル動作が完了する（電源が落ちれば誤作動はしない）。</p> <p>(b) 没水により電源が遮断されない場合は遠隔操作が可能である。</p> <p>(c) 没水により無励磁の箇所が誤って励磁される事象は考えられない。</p> <p>(d) 駆動部が没水状態となったとしても、その時点で空気排出を阻害するほどの水頭圧にならないため、空気排気・弁動作は可能である。</p> <p>(例 計装用圧縮空気系統圧：約0.7MPa⇒水頭約70m)</p> <p>(4) ④「他の設備で代替できる」について</p> <p>他の設備により要求機能が代替できる防護対象設備は機能喪失しても安全機能に影響しないため溢水影響評価対象外とする。代替する設備はすべて逆止弁であり、またQMSに基づいた保全活動により、その機能維持を図っている。図8に系統構成例を示す。</p> <div data-bbox="705 893 1254 1412" style="border: 2px solid red; padding: 5px;"> </div> <p>図8 系統構成例（放射性物質の閉じ込め機能（原子炉格納容器隔離弁））</p>	<p>b. 没水によるフェイル・セーフ動作への影響</p> <p>以下に示すとおり、没水によりフェイル・セーフ機能への影響はないと考える。</p> <p>(a) 没水により電源が遮断されない場合は遠隔操作が可能である。</p> <p>(b) 没水により無励磁の箇所が誤って励磁される事象は考えられない。</p> <p>(c) 駆動部が没水状態となったとしても、その時点で空気排出を阻害するほどの水頭圧にならないため、空気排気・弁動作は可能である。</p> <p>(4) ④「他の設備で代替できる」について</p> <p>他の設備により要求機能が代替できる防護対象設備は機能喪失しても安全機能に影響しないため溢水影響評価対象外とする基準であるが、現状において、泊発電所3号炉の防護対象設備への適用実績はない。</p>	<p>【女川】</p> <p>記載表現の相違</p> <p>設計方針の相違</p> <p>泊では溢水評価対象外とした電磁弁は無いため、記載していない。</p> <p>【女川】</p> <p>記載表現の相違</p> <p>記載方針の相違</p> <p>図4に示したとおり隔離弁の開閉機構が異なるため、泊では女川のような例示は記載していない。</p> <p>設計方針の相違</p> <p>泊では「他の設備で代替できる」との基準を適用し、溢水評価対象外とした設備は無い。</p>

赤字：設備、運用又は体制の相違（設計方針の相違）
 青字：記載箇所又は記載内容の相違（記載方針の相違）
 緑字：記載表現、設備名称の相違（実質的な相違なし）

第9条 溢水による損傷の防止等（別添1添付資料6）

大阪発電所3/4号炉					女川原子力発電所2号炉					泊発電所3号炉					相違理由
(2-1 防護対象設備の抽出の考え方 より抜粋)					表2 溢水影響評価から対象外とした設備一覧 (1/24)					表2 溢水影響評価から対象外とした設備一覧 (1/9)					【大阪】 記載表現の相違 設計方針の相違 プラント設計の違いによる相違 【女川】 記載表現の相違 設計方針の相違 プラント設計の違いによる相違
大阪3号炉防護対象設備のスクリーンアウト (1/10)															
系統	設備	番号	溢水影響 評価対象	スクリーンアウト の考え方	系統	機器番号	設備	理由 ^{※1}	理由 ^{※1}	系統	機器番号	機器名称	理由 ^{※1}		
1次冷却系	3原子炉容器		×	③	AC	T48-F001	バージ用空気供給側隔離弁	③	③	1次冷却系	3PV-452A, B	加圧器逃がし弁	②		
	3A, 3B, 3C, 3D蒸気発生器		×	②	AC	T48-F002	D/Wバージ用入口隔離弁	②	②	1次冷却系	3V-RC-054A, B	加圧器逃がし弁元弁	③		
	3A, 3B, 3C, 3D-1次冷却材ポンプ		×	①	AC	T48-F003	S/Cバージ用入口隔離弁	②	②	1次冷却系	3V-RC-055, 056, 057	加圧器安全弁	①		
	3加圧器		×	③	AC	T48-F004A	格納容器外真空逃がし逆止隔離弁 (A)	①	①	1次冷却系	3LCY-451, 452	抽出ライン第1 (2) 止め弁	②		
	3A, 3B, 3C加圧器安全弁	3V-RC-055, 056, 057		×	①	AC	T48-F004B	格納容器外真空逃がし逆止隔離弁 (B)	①	①	1次冷却系	3LT-451, 452, 453, 454	加圧器水位	②	
	3A, 3B加圧器逃がし弁	3V-CY-452A, B		×	②	AC	T48-F005A	格納容器外真空逃がし隔離弁 (A)	②	②	1次冷却系	3PT-451, 452, 453, 454	加圧器圧力	②	
	3A, 3B加圧器逃がし弁前弁	3V-RC-054A, B		×	①	AC	T48-F005B	格納容器外真空逃がし隔離弁 (B)	②	②	1次冷却系	3PT-410, 430	1次冷却材圧力	②	
	3加圧器逃がしタンクガス分析ライン格納容器側隔離弁	3V-RC-077		×	②	AC	T48-F010	補給用蒸気ガス供給側第二隔離弁	③	③	1次冷却系	3TE-411A, 413A, 415A, 421A, 423A, 425A, 431A, 433A, 435A, 441A, 443A, 445A	1次冷却材高温側温度 (狭域)	②	
	3加圧器逃がしタンクガス分析ライン格納容器側第二隔離弁	3V-RC-078		×	①	AC	T48-F010	補給用蒸気ガス供給側第二隔離弁	③	③	1次冷却系	3TE-411B, 413B, 415B, 421B, 423B, 425B, 431B, 433B, 435B, 441B, 443B, 445B	1次冷却材低温側温度 (狭域)	②	
	3加圧器逃がしタンク蒸気供給ライン格納容器側隔離弁	3V-RC-084		×	①	AC	T48-F011	D/W補給用蒸気ガス供給用第一隔離弁	③	③	1次冷却系	3TE-410, 420, 430	1次冷却材高温側温度 (広域)	②	
	3格納容器内補給水供給ライン格納容器側隔離弁	3V-RC-095		×	①	AC	T48-F012	S/C補給用蒸気ガス供給用第一隔離弁	③	③	1次冷却系	3TE-417, 427, 437	1次冷却材低温側温度 (広域)	②	
	3A, 3B加圧器スプレイ弁	3PCV-451A, B		×	①	AC	T48-F016	バージ用蒸気ガス供給側第二隔離弁	③	③	1次冷却系	3FT-412, 413, 414, 415, 422, 423, 424, 425, 432, 433, 434, 435	1次冷却材流量	③	
	3-1次冷却材圧力	3PT-420, 430		×	②	AC	T48-F019	D/Wベント用出口隔離弁	③	③	1次冷却系	3V-RC-077	加圧器逃がしタンク自動ガス分析ラインC/V内側隔離弁	②	
	3加圧器水位	3LT-451, 452, 453, 454		×	②	AC	T48-F020	ベント用S/G T S側隔離弁	③	③	1次冷却系	3V-RC-078	加圧器逃がしタンク自動ガス分析ラインC/V外側隔離弁	③	
	3A, B, C, D(バー)1次冷却材高温側・低電阻側温度 (広域)	3TE-410, 416, 420, 426, 430, 435, 440, 446		×	②	AC	T48-F021	ベント用H/V A C側隔離弁	②	②	1次冷却系	3V-RC-084	加圧器逃がしタンク蒸気供給ラインC/V外側隔離弁	③	
	3A, B, C, D(バー)1次冷却材高温側・低電阻側温度 (狭域)	3TE-411A, 411B, 411C, 411D, 421A, 421B, 421C, 421D, 431A, 431B, 431C, 431D, 441A, 441B, 441C, 441D		×	②	AC	T48-F022	S/Cベント用出口隔離弁	③	③	1次冷却系	3V-RC-093	加圧器逃がしタンク補給水ラインC/V外側隔離弁	③	
	3加圧器圧力	3PT-451, 452, 453, 454		×	②	AC	T48-F023	D/Wベント用出口隔離弁バイパス弁	③	③	1次冷却系				
	3A, B, C, D(バー)1次冷却材流量	3FT-412, 413, 414, 415, 422, 423, 424, 425, 432, 433, 434, 435, 442, 443, 444, 445		×	②	AC	T48-F024	S/Cベント用出口隔離弁バイパス弁	③	③	1次冷却系				
	1次冷却材ポンプ回転数	3SE-415A, 425A, 435A, 445A		×	②	AC	T48-F043	P/C V副圧強化ベント用遠程配管隔離弁	③	③	1次冷却系				
	3A, 3Bほう酸ポンプ			○	—	AC	T48-F768	事故後サンプリング設備戻り第二隔離弁	③	③	1次冷却系				
3A, 3B, 3C充てんポンプ			○	—	AC	T48-F769	事故後サンプリング設備戻り第一隔離弁	③	③	1次冷却系					
3体積制御タンク			×	③	AC	T48-F7901	バージ用蒸気供給流量	③	③	1次冷却系					
3再生熱交換器			×	③	AC	T48-PT019	圧力抑制定圧力	③	③	1次冷却系					
3A, 3Bほう酸タンク			×	③	AC	T48-S0-F042A	真空破壊弁 (A) 計装用空気配管隔離弁	③	③	1次冷却系					
3ほう酸フィルタ			×	③	AC	T48-S0-F042B	真空破壊弁 (B) 計装用空気配管隔離弁	③	③	1次冷却系					
3封水冷却器			×	③	AC	T48-S0-F042C	真空破壊弁 (C) 計装用空気配管隔離弁	③	③	1次冷却系					
3A, 3B封水注入フィルタ			×	③	AC	T48-S0-F042D	真空破壊弁 (D) 計装用空気配管隔離弁	③	③	1次冷却系					
3封水ストレーナ			×	③	AC	T48-S0-F042E	真空破壊弁 (E) 計装用空気配管隔離弁	③	③	1次冷却系					
3体積制御タンク出口第1止め弁	3LCV-121B		○	—											
3体積制御タンク出口第2止め弁	3LCV-121C		○	—											

※1 評価対象外とした理由
 ①溢水により機能を喪失しない
 ②P/CV内側環境仕様の設備
 ③動作機能の喪失により安全機能に影響しない
 ④他の設備で代替できる

※1 評価対象外とした理由
 ①溢水により機能を喪失しない
 ②原子炉格納容器内環境仕様の設備
 ③動作機能の喪失により安全機能に影響しない
 ④その他の設備で代替できる

赤字：設備、運用又は体制の相違（設計方針の相違）
 青字：記載箇所又は記載内容の相違（記載方針の相違）
 緑字：記載表現、設備名称の相違（実質的な相違なし）

第9条 溢水による損傷の防止等（別添1添付資料6）

大阪発電所3/4号炉					女川原子力発電所2号炉					泊発電所3号炉					相違理由
大阪3号炉防護対象設備のスクリーンアウト（2/10）					表2 溢水影響評価から対象外とした設備一覧（2/24）					表2 溢水影響評価から対象外とした設備一覧（2/9）					【大阪】
系統	設備	番号	溢水影響 評価対象	スクリーンアウト の考え方	系統	機器番号	設備	理由 ^{*1}	系統	機器番号	機器名称	理由 ^{*1}	【大飯】		
化学体積制御系	3号充てんポンプ入口燃料取扱用ホットプレート補給弁A,B	3V-CS-573	○	—	AC	F48-30-F042F	真空破棄弁（F）計装用空気配管隔離弁	③	化学体積制御系	IFCV-138	充てん流量制御弁	③	記載表現の相違 女川審査実績の反映 設計方針の相違 プラント設計の違いによる相違 【大飯】 記載表現の相違 設計方針の相違 プラント設計の違いによる相違		
	3号充てんポンプ入口燃料取扱用ホットプレート補給弁C	3V-CS-121B,E	○	—	AC	F48-30-F708	L S O 1 5 D/W冠水水位計表配管（H）側隔離弁	③	化学体積制御系	IV-CS-167	充てんライン流量制御弁補助オリフィスバイパス弁	③			
	3号充てんライン格納容器隔離弁	3V-CS-157	○	—	AC	F48-30-F710	L S O 1 5 D/W冠水水位計表配管（L）側隔離弁	③	化学体積制御系	KST1	体積制御タンク	①			
	3号充てんライン止め弁	3V-CS-155	○	—	AC	F48-30-F721	露点サンプリング入口第一隔離弁	③	化学体積制御系	IV-CS-191	充てんライン止め弁	③			
	3号充てんライン流量制御弁	3V-CV-138	×	①	AC	F48-30-F722	露点サンプリング入口第二隔離弁	③	化学体積制御系	IV-CS-186	加圧器補助スプレイ弁	②			
	3号冷却材ポンプ封水注入ライン流量制御弁	3V-CV-149	×	①	AC	F48-30-F723	露点サンプリング戻り第一隔離弁	③	化学体積制御系	KSH1	再生熱交換器	①			
	3号抽出ライン第1止め弁	3V-CV-451	×	②	AC	F48-30-F724	露点サンプリング戻り第二隔離弁	③	化学体積制御系	KST5A,B	ほう酸タンク	①			
	3号抽出ライン第2止め弁	3V-CV-452	×	②	AC	F48-30-F725	露点サンプリング戻り第二隔離弁	③	化学体積制御系	KST5A,B	ほう酸タンク	①			
	3A,3B,3C抽出オリフィス出口格納容器第一隔離弁	3V-CS-394A,B,C	×	②	AC	F48-30-F727	漏えい検出系放射線モニタ入口第一隔離弁	③	化学体積制御系	KCSF4	ほう酸フィルタ	①			
	3号圧入格納器スプレイ弁	3V-CS-169	×	②	AC	F48-30-F728	漏えい検出系放射線モニタ入口第二隔離弁	③	化学体積制御系	IV-CS-455A,B	ほう酸タンク出口弁	③			
	3号抽出ライン第1止め弁	3V-CS-301	×	②	AC	F48-30-F729	漏えい検出系放射線モニタ戻り第二隔離弁	③	化学体積制御系	IV-CS-466A,B	ほう酸ポンプ出口補給ライン切替弁	③			
	3号抽出ライン第2止め弁	3V-CS-301	×	②	AC	F48-30-F730	漏えい検出系放射線モニタ戻り第一隔離弁	③	化学体積制御系	IV-CS-473A,B	ほう酸ポンプ出口循環ライン切替弁	③			
	3号抽出ライン格納容器第二隔離弁	3V-CS-007	×	①	AC	F48-30-F730	漏えい検出系放射線モニタ戻り第一隔離弁	③	化学体積制御系	IV-CS-474A,B	ほう酸フィルタ出口A（B）ほう酸タンク戻り弁	③			
	3号充てんライン流量制御弁前止め弁	3V-CS-151	×	①	AC	F48-30-F772	T 4 8 - L S O 2 5 D/W水位計表配管（L）側隔離弁	③	化学体積制御系	IV-CS-499A,B	ほう酸ポンプ入口切替弁	③			
	3号ループ充てんライン止め弁	3V-CS-162	×	①	AC	F48-30-F774	T 4 8 - L S O 2 5 D/W水位計表配管（H）側隔離弁	③	化学体積制御系	IV-CS-004A,B,C	抽出オリフィス出口C/V内側隔離弁	②			
	3号1次冷却材ポンプ封水注入ライン流量制御弁前止め弁	3V-CS-177	×	①	CMSS	023-3001A	校正ガスボンベサポート	①	化学体積制御系	IV-CS-004A,B	ほう酸ポンプ出口切替弁	③			
	3号1次冷却材ポンプ封水注入ライン格納容器第一隔離弁	3V-CS-196A,B,C,D	×	①	CMSS	023-3001B	校正ガスボンベサポート	①	化学体積制御系	IV-CS-004A,B,C	抽出オリフィス出口C/V内側隔離弁	②			
	3号1次冷却材ポンプ封水戻りライン格納容器第二隔離弁	3V-CS-319	×	②	CRD	C12	制御棒駆動機構	①	化学体積制御系	IV-CS-004A,B,C	抽出オリフィス出口C/V内側隔離弁	②			
	3号1次冷却材ポンプ封水戻りライン格納容器第二隔離弁	3V-CS-312	○	—	CRD	C12	制御棒駆動機構	①	化学体積制御系	IV-CS-006	抽出ライン格納容器外側隔離弁	③			
	3号1次冷却材ポンプ封水戻りライン流量制御弁	3V-CS-208A,B,C,D	×	②	CRD	C12-3001-120	方向制御弁	③	化学体積制御系	IV-CS-224A,B,C	1次冷却材ポンプ封水注入ラインC/V外側隔離弁	③			
	3A,3Bほう酸タンク水位	3LT-205,206	○	—	CRD	C12-3001-123	方向制御弁	③	化学体積制御系	IV-CS-254	1次冷却材ポンプ封水戻りラインC/V内側隔離弁	②			
	3号充てんポンプ速度制御盤	3VSC	○	—	CRD	C12-3001-125	アキュムレータ	①	化学体積制御系	IV-CS-212A,B,C	1次冷却材ポンプ封水戻りオリフィスバイパス弁	③			
	3号充てんポンプ速度制御補助盤	3VSCM	○	—	CRD	C12-3001-126	スクラム入口弁	②	化学体積制御系	IV-CS-214	1次冷却材ポンプ封水戻りオリフィスバイパス弁	③			
	3A,3B,3C1,3C2充てんポンプ現場操作箱	3LB-5,6,7,8	○	—	CRD	C12-3001-128	要素容器	①	化学体積制御系	IV-CS-212A,B,C	1次冷却材ポンプ封水戻りオリフィスバイパス弁	③			
	3A,3Bほう酸ポンプ現場操作箱	3LB-9,10	○	—	CRD	C12-3001-132	制御棒駆動水圧素ラプチュアディスク	①	化学体積制御系	IV-CS-212A,B,C	1次冷却材ポンプ封水戻りオリフィスバイパス弁	③			
	3A,3B高圧注入ポンプ		○	—	CRD	C12-3001-135	方向制御弁フィルタ	①							
	3A,3B,3C,3D蓄圧タンク		×	⑤	CRD	C12-3001-139	スクラムバイパス弁	③							
	3A,3B高圧注入ポンプミニマムフローライン第1止め弁	3V-S1-015A,B	○	—	CRD	C12-096129	H C U アキュムレータレベルスイッチ	③							
	3A,3B高圧注入ポンプミニマムフローライン第2止め弁	3V-S1-016A,B	○	—	CRD	C12-01131	H C U アキュムレータ圧力指示計	③							
	3A,3B高圧注入ポンプ格納容器再循環ライン格納容器第一隔離弁	3V-S1-099A,B	○	—	CRD	C12-05130	H C U アキュムレータ圧力スイッチ	③							
3A,3B高圧注入ポンプ格納容器再循環ライン格納容器第二隔離弁	3V-S1-092A,B	○	—												
3A,3B余熱除去ポンプRWSピット及び循環ポンプ格納容器	3V-S1-096A,B	○	—												
3A,3B高圧注入ライン格納容器隔離弁	3V-S1-062A,B	×	①												
3A,3B高圧注入ポンプ出口連絡弁	3V-S1-066A,B	×	②												

※1 評価対象外とした理由
 ①溢水により機能を喪失しない
 ②ICV内耐震域仕様の設備
 ③動作機能の喪失により安全機能に影響しない
 ④他の設備で代替できる

*1 評価対象外とした理由
 ①溢水により機能を喪失しない
 ②原子炉格納容器内耐震域仕様の設備
 ③動作機能の喪失により安全機能に影響しない
 ④その他の設備で代替できる

赤字：設備、運用又は体制の相違（設計方針の相違）
 青字：記載箇所又は記載内容の相違（記載方針の相違）
 緑字：記載表現、設備名称の相違（実質的な相違なし）

大阪発電所3/4号炉						女川原子力発電所2号炉				泊発電所3号炉				相違理由	
大阪3号炉防護対象設備のスクリーンアウト (3/10)						表2 溢水影響評価から対象外とした設備一覧 (3/24)				表2 溢水影響評価から対象外とした設備一覧 (3/9)				【大阪】	
系統	設備	番号	溢水影響 評価対象	スクリーンアウト の考え方		系統	機器番号	設備	理由 ^{#1}	系統	機器番号	機器名称	理由 ^{#1}		
安全注入系	3A, 3B高圧注入ポンプ高圧側圧入ライン止め弁	3V-SI-007A, B	×	②		CUW	G31-P002	C.U.W.入口ライン第一隔離弁	②	高圧注入系	3SIT2	ほう酸注入タンク	①	【大阪】 記載表現の相違 女川審査実績の反映 設計方針の相違 プラント設計の違いによる相違	
	3A, 3B, 3C, 3D高圧タンク出口弁	3V-SI-132A, B, C, D	×	②		DG	R43-A001A	清水膨張タンク (A)	①	高圧注入系	3V-SI-001A, B	高圧注入ポンプ出口 C/V 内側隔離弁	②		
	格納容器再循環サンプ水位 (狭域) (広域)	3LT-670, 971 (372A, 973)	×	②		DG	R43-A001B	清水膨張タンク (B)	①	高圧注入系	3V-SI-002A, B	高圧側高圧注入 (B) ライン止め弁	②		
	3A, 3B高圧注入ポンプ現場操作箱	3E-B-12, 13	○	—		DG	R43-A100A	潤滑油サンプタンク (A)	①	高圧注入系	3V-SI-141	ほう酸注入タンク循環ライン入口止め弁	③		
	3A高圧注入流量 (I), 3B高圧注入流量 (II)	3PT-062, 963	○	—		DG	R43-A100B	潤滑油サンプタンク (B)	①	高圧注入系	3V-SI-145, 146	ほう酸注入タンク循環ライン出口第1 (2) 止め弁	③		
	3燃料取扱用ホット水位 I, II, III, IV	3LT-1400, 1401 (1402, 1403)	○	—		DG	R43-A101A	機関付動弁注油タンク (A)	①	高圧注入系	3CVT2, 3	格納容器再循環サンプ	①		
	3A, 3B余熱除去ポンプ		○	—		DG	R43-A101B	機関付動弁注油タンク (B)	①	高圧注入系	3LT-620, 630	格納容器再循環サンプ水位 (広域)	②		
	3A, 3B余熱除去冷却器	3PCV-601, 611	×	③		DG	R43-A101B	機関付動弁注油タンク (B)	①	高圧注入系	3LT-621, 631	格納容器再循環サンプ水位 (狭域)	②		
	3A, 3B余熱除去ポンプミニウムフローライン止め弁	3PCV-601, 611	○	—		DG	R43-A200A	軽油タンク (A)	①	高圧注入系	3SIT1A, B, C	蓄圧タンク	①		
	3A, 3B余熱除去冷却器出口流量設定弁	3PCV-603, 613	×	①		DG	R43-A200B	軽油タンク (B)	①	高圧注入系	3V-SI-123A, B, C	蓄圧タンクサンプリングライン C/V 内側隔離弁	②		
余熱除去系	3A, 3B余熱除去冷却器バイパス流量制御弁	3PCV-604, 614	×	①		DG	R43-A200C	軽油タンク (C)	①	高圧注入系	3V-SI-124	蓄圧タンクサンプリングライン C/V 外側隔離弁	③	【女川】 記載表現の相違 設計方針の相違 プラント設計の違いによる相違	
	3A, 3B余熱除去ポンプR, Cグループ高圧側入口止め弁	3PCV-420, 430	×	②		DG	R43-A200D	軽油タンク (D)	①	高圧注入系	3V-SI-164	蓄圧タンク資源供給ライン C/V 外側隔離弁	③		
	3A, 3B余熱除去ポンプ入口格納容器隔離弁	3V-RH-002A, B	×	②		DG	R43-A200E	軽油タンク (E)	①	高圧注入系	3V-SI-184	安全注入逆止弁テストライン C/V 内側隔離弁	②		
	3A, 3B余熱除去冷却器出口格納容器隔離弁	3V-RH-043A, B	×	①		DG	R43-A200F	軽油タンク (F)	①	高圧注入系	3V-SI-185	蓄圧タンク補給ライン C/V 外側隔離弁	③		
	3A, 3B 余熱除去冷却器出口連絡弁	3V-RH-047A, B	×	②		DG	R43-A201A	燃料デایتンク (A)	①	高圧注入系	3V-SI-186	安全注入逆止弁テストライン C/V 外側隔離弁	③		
	3B, 3Cグループ高圧側圧入ライン止め弁	3PT-010, 611	×	②		DG	R43-A201B	燃料デایتンク (B)	①	余熱除去系	3RH1A, B	余熱除去冷却器	①		
	3A, 3B余熱除去ポンプ出口流量	3PT-601, 611	○	—		DG	R43-A300A	空気だめ (自動) (A)	①	余熱除去系	3HCV-603, 613	余熱除去冷却器出口流量調節弁	③		
	3A, 3B余熱除去ポンプ現場操作箱	3E-B-14, 15	○	—		DG	R43-A300B	空気だめ (自動) (B)	①	余熱除去系	3PCV-604, 614	余熱除去 (A) ライン流量制御弁	③		
	3A, 3B格納容器スプレイポンプ		○	—		DG	R43-B001A	清水冷却器 (A)	①	余熱除去系	3PCV-110, 430	余熱除去 (B) ライン入口止め弁	②		
	3A, 3B格納容器スプレイ冷却器		×	③		DG	R43-B001B	清水冷却器 (B)	①	余熱除去系	3V-RH-002A, B	余熱除去ポンプ入口 C/V 内側隔離弁	②		
格納容器スプレイ系	3よう素除去薬品タンク		×	③		DG	R43-B003A-1	機関付空気冷却器 (L BD)	①	余熱除去系	3V-RH-029A, B	余熱除去 (A) ライン C/V 外側隔離弁	③	*1 評価対象外とした理由 ①溢水により機能を喪失しない ②原子炉格納容器内前環境仕様の設備 ③動作機能の喪失により安全機能に影響しない ④その他の設備で代替できる	
	3-19調整用タンク		×	③		DG	R43-B003A-2	機関付空気冷却器 (R BD)	①	余熱除去系	3V-RH-033A, B	余熱除去冷却器出口 C/V 内側隔離弁	②		
	3A, 3Bよう素除去薬品注入ライン第1止め弁	3V-CF-054A, B	○	—		DG	R43-B003B-1	機関付空気冷却器 (L BD)	①	余熱除去系	3V-RH-034A, B	高圧側低圧注入ライン止め弁	②		
	3A, 3Bよう素除去薬品注入ライン第2止め弁	3V-CF-056A, B	○	—		DG	R43-B100A	潤滑油冷却器 (A)	①	主給水系	3LT-460, 461, 462, 473, 480, 481, 482, 483	蒸気発生器水位 (狭域)	②		
	3A, 3B格納容器スプレイポンプ燃料取扱用ホット投入止め弁	3V-CF-991A, B	○	—		DG	R43-B100B	潤滑油冷却器 (B)	①	主給水系	3LT-464, 474, 484	蒸気発生器水位 (広域)	②		
	3A, 3B格納容器スプレイポンプ再循環サンプ投入口格納容器隔離弁	3V-CF-003A, B	○	—		DG	R43-D100A	潤滑油フィルタ (A)	①						
	3A, 3B格納容器スプレイ冷却器出口格納容器隔離弁	3V-CF-024A, B	○	—		DG	R43-D100B	潤滑油フィルタ (B)	①						
	3格納容器圧力 (広域) I, II, III, IV	3PT-950, 951, 952, 953	○	—											
	3A, 3B格納容器スプレイポンプ現場操作箱	3E-B-18, 19	○	—											
	3タービン動機給水ポンプ		○	—											
主蒸気及び主給水系、補助給水系	3A, 3B電動補助給水ポンプ		○	—											
	3復水ピット		×	③											
	3タービン動機補助給水ポンプ起動弁A, B	3V-RS-570A, B	○	—											
	3A, 3B, 3C, 3D補助給水隔離弁	3V-F9-574A, B, C, D	×	③											

*1 評価対象外とした理由
 ①溢水により機能を喪失しない
 ②原子炉格納容器内前環境仕様の設備
 ③動作機能の喪失により安全機能に影響しない
 ④その他の設備で代替できる

赤字：設備、運用又は体制の相違（設計方針の相違）
 青字：記載箇所又は記載内容の相違（記載方針の相違）
 緑字：記載表現、設備名称の相違（実質的な相違なし）

大飯発電所3/4号炉					女川原子力発電所2号炉				泊発電所3号炉				相違理由								
大飯3号炉防護対象設備のスクリーンアウト (4/10)					表2 溢水影響評価から対象外とした設備一覧 (4/24)				表2 溢水影響評価から対象外とした設備一覧 (4/9)				【大飯】								
系統	設備	番号	溢水影響 評価対象	スクリーンアウト の考え方	系統	機器番号	設備	理由 ^{※1}	系統	機器番号	機器名称	理由 ^{※1}									
主蒸気及び 予熱給水系	3A,3B,3C,3D電動補助給水ライン流量調整弁	3V-F9-557A,B,C,D	×	①	06	R43-0200A	燃料移送ポンプ入ロストレーナ (A)	①	主蒸気系	30KV-3016,3026, 3036	主蒸気バイパス隔離弁	③	【大飯】 記載表現の相違 女川審査実績の反映 設計方針の相違 プラント設計の違いによる相違								
	3復水ピット電動補助給水ポンプ種止め弁	3V-F9-589	×	①	06	R43-0200B	燃料移送ポンプ入ロストレーナ (B)	①		主蒸気系	3V-MS-521A,B,C, 522A,B,C, 523A,B,C, 524A,B,C, 525A,B,C	主蒸気安全弁		④							
	3復水ピットタービン補助給水ポンプ種止め弁	3V-F9-591	×	①	06	R43-0201A	D/G蒸気移送ポンプ出口フィルタ (A)	①			主蒸気系	3V-MS-575A,B		タービン補助給水ポンプ駆動蒸気B (C)	③						
	3A,3B,3C,3Dタービン補助給水ライン流量調整弁	30KV-371B,372B, 373B,374B	×	①	06	R43-0201B	D/G蒸気移送ポンプ出口フィルタ (B)	①				主蒸気系		3V-MS-518A,B,C	主蒸気ライン弁弁	③					
	3A,3Bタービン補助給水ポンプ駆動蒸気供給ライン止め弁	3V-MS-575A,B	×	①	06	R43-0202A-1	燃料油フィルタ (A) - 1	①						主蒸気系	3V-MS-518A,B,C	主蒸気逃がし弁弁弁	③				
	3A,3B,3C,3D主給水隔離弁	3V-F9-520A,B,C,D	×	②	06	R43-0202A-2	燃料油フィルタ (A) - 2	①							主蒸気系	3V-MS-581	非常用タービンブランド蒸気弁弁	③			
	3復水ピット水位III,IV	3LT-3760,3791	○	—	06	R43-0202B-1	燃料油フィルタ (B) - 1	①								主蒸気系	3V-MS-601A,B,C	主蒸気隔離弁上流ドレンライン隔離弁	③		
	3A,3B,3C,3D蒸気発生器補助給水流量調整弁	3PT-371B,372B, 373B,374B	○	—	06	R43-0202B-2	燃料油フィルタ (B) - 2	①									補助給水系	30W-P	補助給水ピット	④	
	3A,B,C,D蒸気発生器広域水位	3LT-384,374,384,394	×	②	06	R43-0300A	給動用空気ストレーナ (A)	①										原子炉 格納容器 スプレイ系	30CT1	よう素除去薬品タンク	④
	3A,B,C,D蒸気発生器狭域水位	3LT-385,386,387,388, 389,391,392,393	×	②	06	R43-0300B	給動用空気ストレーナ (B)	①											原子炉 格納容器 スプレイ系	30PH1A,B	格納容器スプレイ冷却器
	3タービン補助給水ポンプ駆動蒸気A,B	5TDP-A,B	○	—	06	R43-0301A	給動用空気ストレーナ (A)	①	原子炉 格納容器 スプレイ系				3V-CP-056A,B							よう素除去薬品タンク注入 (B) ライン止め弁後弁	③
	3A,3B,3C,3D主蒸気隔離弁	3V-MS-529A,B,C,D	○	—	06	R43-0301B	給動用空気ストレーナ (B)	①		原子炉 格納容器 スプレイ系			30CT1							原子炉補機冷却水サーージタンク	④
	3A,3B,3C,3D主蒸気隔離弁バイパス弁	30KV-391B,392B, 393B,394B	×	①	06	R43-0302A	燃料油フィルタ差圧スイッチ	③			原子炉 格納容器 スプレイ系		30CH1A,B,C,D							原子炉補機冷却水冷却器	④
	3A,3B,3C,3D主蒸気逃がし弁	30KV-361B,362B, 363B,364B	○	—	06	R43-04S105A	潤滑油フィルタ差圧スイッチ	③				原子炉 格納容器 スプレイ系	3V-CC-054A,B,C,D							原子炉補機冷却水冷却器補機冷却水出口弁	③
	3A,3B,3C,3D-1主蒸気安全弁	3V-MS-526A,B,C,D	×	①	06	R43-04S105B	潤滑油フィルタ差圧スイッチ	③					原子炉 格納容器 スプレイ系	3V-CC-526						1次冷却材ポンプ補機冷却水出口C/V内側隔離弁	②
	3A,3B,3C,3D-2主蒸気安全弁	3V-MS-527A,B,C,D	×	①	06	R43-04S210A	燃料油フィルタ差圧スイッチ	③						使用済燃料 ピット水浄化 冷却系	3A-SFP,3B-SFP					使用済燃料ピット	④
	3A,3B,3C,3D-3主蒸気安全弁	3V-MS-528A,B,C,D	×	①	06	R43-04S210B	燃料油フィルタ差圧スイッチ	③							※1 評価対象外とした理由 ①溢水により機能を喪失しない ②原子炉格納容器内耐震仕様の設備 ③動作機能の喪失により安全機能に影響しない ④他の設備で代替できる						
	3A,3B,3C,3D-4主蒸気安全弁	3V-MS-529A,B,C,D	×	①	06	R43-5200A	プレキシブルチューブ	①													
	3A,3B,3C,3D-5主蒸気安全弁	3V-MS-530A,B,C,D	×	①	06	R43-5200B	プレキシブルチューブ	①													
	3A,3B,3C,3D主蒸気隔離弁上流ドレンライン止め弁	3V-MS-585A,B,C,D	×	①	06	R43-L1S005A	清水洗浄タンク水位指示計 (接点付)	③													
3A,3B,3C,3D主蒸気逃がし弁弁弁	3V-MS-529A,B,C,D	×	①	06	R43-L1S005B	清水洗浄タンク水位指示計 (接点付)	③														
1,II,III,IV,3A,3B,3C,3D主蒸気圧力	3PT-405,386,407,364, 423,416,471,473, 485,386,487,388, 495,499,497,493	○	—	06	R43-L1S100A	潤滑油サンプタンク油面指示計 (接点付)	③														
3A,3B,3C,3D原子炉補機冷却水ポンプ		○	—	06	R43-L1S100B	潤滑油サンプタンク油面指示計 (接点付)	③														
3原子炉補機冷却水サーージタンク		× ^{※1}	③	06	R43-L1S201A	軽油貯蔵タンクA液面計	③														
3A,3B原子炉補機冷却水冷却器		× ^{※1}	③	06	R43-L1S201B	軽油貯蔵タンクB液面計	③														
3A,3B格納容器スプレイ冷却器母管止め弁	3V-CC-158A,B	○	—	06	R43-LS116A	機関付動弁注油タンク油面	③														
3A-C,3B-C原子炉補機冷却水供給母管連絡弁	3V-CC-056A,B	○	—	06	R43-LS116B	機関付動弁注油タンク油面	③														
3A-C,3B-C原子炉補機冷却水戻り母管連絡弁	3V-CC-043A,B	○	—	06	R43-LS257A	シリンドラ浸水スイッチ	③														
3A,3B余熱除去冷却器冷却水止め弁	3V-CC-118A,B	○	—																		
3-1次冷却材ポンプ冷却水供給ライン格納容器隔離弁	3V-CC-403	○	—																		
3-1次冷却材ポンプ冷却水戻りライン格納容器隔離弁 (隔離弁)	3V-CC-427	×	②																		

赤字：設備、運用又は体制の相違（設計方針の相違）
 青字：記載箇所又は記載内容の相違（記載方針の相違）
 緑字：記載表現、設備名称の相違（実質的な相違なし）

第9条 溢水による損傷の防止等（別添1添付資料6）

大阪発電所3/4号炉					女川原子力発電所2号炉				泊発電所3号炉				相違理由		
大阪3号炉防護対象設備のスクリーンアウト（5/10）					表2 溢水影響評価から対象外とした設備一覧（5/24）				表2 溢水影響評価から対象外とした設備一覧（5/9）				【大阪】		
系統	設備	番号	溢水影響評価対象	スクリーンアウトの考え方	系統	機器番号	設備	理由*1	系統	機器番号	機器名称	理由*1			
原子炉補機冷却系	3-1次冷却ポンプ正常戻りライン格納容器内設置	3V-CC-429	○	—	① 溢水により機能を喪失しない ② C/V内設置仕様の設備 ③ 動作機能の喪失により安全機能に影響しない ④ 他の設備で代替される	06	R43-LS257B	シリンダー戻水スイッチ	②	使用済燃料ピット水浄化冷却系	3SPF1A,B	使用済燃料ピット冷却器	①	【大阪】 記載表現の相違 女川審査実績の反映 設計方針の相違 プラント設計の違いによる相違	
	3-4次冷却ユニット・全列抽出冷却器冷却水供給ライン設置	3V-CC-342	○	—		06	R43-P1052A	機器付排水ポンプ出口圧力指示計	③	使用済燃料ピット水浄化冷却系	3SPF1A,B	使用済燃料ピット脱塩塔	①		
	3-4次冷却ユニット・全列抽出冷却器冷却水供給ライン設置	3V-CC-365	○	—		06	R43-P1052B	機器付排水ポンプ出口圧力指示計	③	使用済燃料ピット水浄化冷却系	3SPF1A,B	使用済燃料ピットフィルタ	①		【女川】 記載表現の相違 設計方針の相違 プラント設計の違いによる相違
	3-4次冷却ユニット・全列抽出冷却器冷却水供給ライン設置	3V-CC-189A,B	○	—		06	R43-P1191A	機器付潤滑油ポンプ出口圧力指示計	③	液体廃棄物処理系	3V-9L-005	CVBT自動ガス分析ラインC/V内側隔離弁	②		
	3-4次冷却ユニット・全列抽出冷却器冷却水供給ライン設置	3V-CC-189A,B,C,D	○	—		06	R43-P1191B	機器付潤滑油ポンプ出口圧力指示計	③	液体廃棄物処理系	3V-9L-006	CVBT自動ガス分析ラインC/V外側隔離弁	③		
	3-4次冷却ユニット・全列抽出冷却器冷却水供給ライン設置	34V-CC-600,601	○	—		06	R43-P1202A	燃料油ストレーナ前後圧力指示計	③	液体廃棄物処理系	3V-9L-010	格納容器冷却材ドレンタンクバントラインC/V内側隔離弁	②		
	3-4次冷却ユニット・全列抽出冷却器冷却水供給ライン設置	SLT-1200,1201	○	—		06	R43-P1202B	燃料油ストレーナ前後圧力指示計	③	液体廃棄物処理系	3V-9L-011	格納容器冷却材ドレンタンクバントラインC/V外側隔離弁	③		
	3-4次冷却ユニット・全列抽出冷却器冷却水供給ライン設置	3LB-20,21,22,23	○	—		06	R43-P1203A	燃料移送ポンプ出口圧力指示計	③	液体廃棄物処理系	3V-9L-017	格納容器冷却材ドレンタンク電素供給C/V隔離弁	③		
	3-4次冷却ユニット・全列抽出冷却器冷却水供給ライン設置	3A,3B,3C海水ポンプ	○	—		06	R43-P1203B	燃料移送ポンプ出口圧力指示計	③	液体廃棄物処理系	3V-9L-031	格納容器冷却材ドレンポンプ出口C/V内側隔離弁	②		
	3-4次冷却ユニット・全列抽出冷却器冷却水供給ライン設置	3S-SF-01A,B,C,D	○	—		06	R43-P1211A	機器入口燃料油圧力指示計	③	液体廃棄物処理系	3V-9L-032	格納容器冷却材ドレンポンプ出口C/V外側隔離弁	③		
	3-4次冷却ユニット・全列抽出冷却器冷却水供給ライン設置	3S-SF-02A,B,C,D	○	—		06	R43-P1211B	機器入口燃料油圧力指示計	③	液体廃棄物処理系	3V-9L-113	格納容器サンポンプ出口C/V内側隔離弁	②		
	3-4次冷却ユニット・全列抽出冷却器冷却水供給ライン設置	3S-SF-03A,B,C	○	—		06	R43-P1255A	機器入口吸気圧力（L側）指示計	③	液体廃棄物処理系	3V-9L-114	格納容器サンポンプ出口C/V外側隔離弁	③		
	3-4次冷却ユニット・全列抽出冷却器冷却水供給ライン設置	3V-SF-570A,B	○	—		06	R43-P1255B	機器入口吸気圧力（R側）指示計	③	液体廃棄物処理系	3V-SS-504	加圧器気相部サンプリングラインC/V内側隔離弁	②		
	3-4次冷却ユニット・全列抽出冷却器冷却水供給ライン設置	3LB-26,27,28,29	○	—		06	R43-P1256A	機器入口吸気圧力（R側）指示計	③	液体廃棄物処理系	3V-SS-509	加圧器液相部サンプリングラインC/V内側隔離弁	②		
	3-4次冷却ユニット・全列抽出冷却器冷却水供給ライン設置	3A,3B1,3B2,3C海水ポンプ	○	—		06	R43-P1256B	機器入口吸気圧力（L側）指示計	③						
	3-4次冷却ユニット・全列抽出冷却器冷却水供給ライン設置	3LB-26,27,28,29	○	—		06	R43-P1256C	機器入口吸気圧力（R側）指示計	③						
	3-4次冷却ユニット・全列抽出冷却器冷却水供給ライン設置	3LB-26,27,28,29	○	—		06	R43-P1S108A	機器潤滑油圧力	③						
	3-4次冷却ユニット・全列抽出冷却器冷却水供給ライン設置	3LB-26,27,28,29	○	—		06	R43-P1S108B	機器潤滑油圧力	③						
	3-4次冷却ユニット・全列抽出冷却器冷却水供給ライン設置	3LB-26,27,28,29	○	—		06	R43-P1S113A	潤滑油プライミングポンプ出口圧力指示計（接点付）	③						
	3-4次冷却ユニット・全列抽出冷却器冷却水供給ライン設置	3LB-26,27,28,29	○	—		06	R43-P1S113B	潤滑油プライミングポンプ出口圧力指示計（接点付）	③						
燃料ピット冷却浄化系	3A,3B使用済燃料ピット	○	×	②	06	R43-PS253A	空気だめ圧力（自動）指示計（接点付）	③							
	3A,3B,3C使用済燃料ピット冷却器	×	×	②	06	R43-PS253B	空気だめ圧力（自動）指示計（接点付）	③							
	3A,3B使用済燃料ピット脱塩塔	×	×	②	06	R43-Ps260A	燃料ハンドル位置異常スイッチ	③							
	3A,3B使用済燃料ピットフィルタ	×	×	②	06	R43-Ps260B	燃料ハンドル位置異常スイッチ	③							
	3A,3B使用済燃料ピットポンプ	○	×	②	06	R43-Ps262A	ターニングハンドル位置異常スイッチ	③							
	3A,3B使用済燃料ピットポンプ	○	×	②	06	R43-Ps262B	ターニングハンドル位置異常スイッチ	③							
	3A,3B使用済燃料ピットポンプ	○	×	②	06	R43-Ps250A	空気だめ圧力（自動）スイッチ	③							
	3A,3B使用済燃料ピットポンプ	○	×	②	06	R43-Ps250B	空気だめ圧力（自動）スイッチ	③							
	3A,3B使用済燃料ピットポンプ	○	×	②											
	3A,3B使用済燃料ピットポンプ	○	×	②											
燃料取替用水系	3A,3B燃料取替用水ポンプ	○	×	②											
	3A,3B燃料取替用水ポンプ	○	×	②											
	3A,3B燃料取替用水ポンプ	○	×	②											
	3A,3B燃料取替用水ポンプ	○	×	②											
	3A,3B燃料取替用水ポンプ	○	×	②											
	3A,3B燃料取替用水ポンプ	○	×	②											
	3A,3B燃料取替用水ポンプ	○	×	②											
	3A,3B燃料取替用水ポンプ	○	×	②											
	3A,3B燃料取替用水ポンプ	○	×	②											
	3A,3B燃料取替用水ポンプ	○	×	②											
蒸気発生器ブローダウン系	3A,3B,3C,3Dブローダウンライン格納容器隔離弁	3V-BD-101A,B,C,D	×	①											
	3A,3B,3C,3D蒸気発生器試料採取ライン格納容器隔離弁	3V-SD-910A,B,C,D	×	①											
	3A,3B,3C,3D蒸気発生器試料採取ライン格納容器第1隔離弁	3V-SS-503	×	②											
	3A,3B,3C,3D蒸気発生器試料採取ライン格納容器第2隔離弁	3V-SS-508	×	②											
	3A,3B,3C,3D蒸気発生器試料採取ライン格納容器第3隔離弁	3V-SS-522	×	②											
	3A,3B,3C,3D蒸気発生器試料採取ライン格納容器第4隔離弁	3V-SS-507	×	②											
	3A,3B,3C,3D蒸気発生器試料採取ライン格納容器第5隔離弁	3V-SS-525	×	②											
	3A,3B,3C,3D蒸気発生器試料採取ライン格納容器第6隔離弁	3V-SS-526	×	②											
	3A,3B,3C,3D蒸気発生器試料採取ライン格納容器第7隔離弁	3V-SS-593A,B,C,D	×	②											
	3A,3B,3C,3D蒸気発生器試料採取ライン格納容器第8隔離弁	3V-SS-594	×	②											
1次系試料採取系	3A,3B,3C,3D蒸気発生器試料採取ライン格納容器第1隔離弁	3V-SS-574	×	①											
	3A,3B,3C,3D蒸気発生器試料採取ライン格納容器第2隔離弁	3V-SS-594	×	①											
	3A,3B,3C,3D蒸気発生器試料採取ライン格納容器第3隔離弁	3V-SS-574	×	①											
	3A,3B,3C,3D蒸気発生器試料採取ライン格納容器第4隔離弁	3V-SS-574	×	①											
	3A,3B,3C,3D蒸気発生器試料採取ライン格納容器第5隔離弁	3V-SS-574	×	①											
	3A,3B,3C,3D蒸気発生器試料採取ライン格納容器第6隔離弁	3V-SS-574	×	①											
	3A,3B,3C,3D蒸気発生器試料採取ライン格納容器第7隔離弁	3V-SS-574	×	①											
	3A,3B,3C,3D蒸気発生器試料採取ライン格納容器第8隔離弁	3V-SS-574	×	①											
	3A,3B,3C,3D蒸気発生器試料採取ライン格納容器第9隔離弁	3V-SS-574	×	①											
	3A,3B,3C,3D蒸気発生器試料採取ライン格納容器第10隔離弁	3V-SS-574	×	①											
制御用空気系	3A,3B制御用空気圧縮機	○	○	—											

赤字：設備、運用又は体制の相違（設計方針の相違）
 青字：記載箇所又は記載内容の相違（記載方針の相違）
 緑字：記載表現、設備名称の相違（実質的な相違なし）

第9条 溢水による損傷の防止等（別添1添付資料6）

大阪発電所3/4号炉					女川原子力発電所2号炉				泊発電所3号炉				相違理由	
大阪3号炉防護対象設備のスクリーンアウト (6/10)					表2 溢水影響評価から対象外とした設備一覧 (6/24)				表2 溢水影響評価から対象外とした設備一覧 (6/9)				【大阪】 記載表現の相違 女川審査実績の反映 設計方針の相違 プラント設計の違いによる相違 【女川】 記載表現の相違 設計方針の相違 プラント設計の違いによる相違	
系統	設備	番号	溢水影響 評価対象	スクリーンアウト の考え方	系統	機器番号	設備	理由*	系統	機器番号	機器名称	理由*		
制御用空気系	3A, 3B制御用空気乾燥器	3IAHA, B	×	②	06	R43-PS231A	空気だめ圧力（自動）スイッチ	②	06	IV-SS-514, 519	B (C) ループ高温側サンプリングライン C/V 内側隔離弁	②		
	3A, 3B制御用空気だめ	3IATA, B	×	②		R43-PS231B	空気だめ圧力（自動）スイッチ	③		06	IV-SS-521A	B ループ高温側、加圧器サンプリングライン C/V 外側隔離弁	③	
	3A, 3B制御用空気主蒸気遮断弁等供給ライン止め弁	3V-1A-505A, B	○	—		R43-TE331A	非常用D/G (A) 固定子巻線温度 (U相) 検出器	③		06	IV-SS-521B	C ループ高温側サンプリングライン C/V 内側隔離弁	③	
	3A-C, 3B-C制御用空気母管遮断弁	3V-1A-501A, B	○	—		R43-TE331B	非常用D/G (B) 固定子巻線温度 (U相) 検出器	③		06	IV-SS-718	PASS 1 次冷却材サンプル戻りライン C/V 外側隔離弁	③	
	3A, 3B制御用空気格納容器隔離弁	3V-1A-508A, B	○	—		R43-TE332A	非常用D/G (A) 固定子巻線温度 (V相) 検出器	③		06	格納容器減圧設備及び格納容器水素制御設備	IV-DP-001A, B	格納容器減圧ライン格納容器内側隔離弁	②
	3A, 3B格納容器内前部Bクラス制御用空気母管出前止め弁	3V-1A-510A, B	×	②		R43-TE332B	非常用D/G (B) 固定子巻線温度 (V相) 検出器	③		06	格納容器減圧設備及び格納容器水素制御設備	IV-DP-002A, B	格納容器減圧ライン格納容器外側隔離弁	③
	3A, 3B制御用空気供給母管圧力	3PT-1809, 1810	○	—		R43-TE333A	非常用D/G (A) 固定子巻線温度 (W相) 検出器	③		06	格納容器減圧設備及び格納容器水素制御設備	IV-HE-304A, B	格納容器水素ページ給気ライン格納容器外側隔離弁	④
	3A, 3B制御用空気圧縮機制御弁	3IAC-A, B	○	—		R43-TE333B	非常用D/G (B) 固定子巻線温度 (W相) 検出器	③		06	放射線監視設備空気サンプリング系	IV-RM-001	格納容器空気サンプル取出し格納容器内側隔離弁	②
	3格納容器冷却却ドレンタンクガス分折ライン格納容器第1隔離弁	3V-4L-078	×	②		R43-TE334A	非常用D/G (A) 固定子巻線温度 (U相) 検出器	③		06	放射線監視設備空気サンプリング系	IV-RM-002	格納容器空気サンプル取出し格納容器外側隔離弁	③
	3格納容器冷却却ドレンタンクガス分折ライン格納容器第2隔離弁	3V-4L-079	×	①		R43-TE334B	非常用D/G (B) 固定子巻線温度 (U相) 検出器	③		06	蒸気発生器ブローダウン系	IV-BD-028A, B, C	ブローダウン止め弁	③
廃棄物処理系	3格納容器冷却却ドレンタンクベントライン格納容器第1隔離弁	3V-4L-082	×	②	R43-TE334C	非常用D/G (A) 固定子巻線温度 (U相) 検出器	③	06	蒸気発生器ブローダウン系	IV-BD-008A, B, C	蒸気発生器サンプリングライン C/V 外側隔離弁	④		
	3格納容器冷却却ドレンタンクベントライン格納容器第2隔離弁	3V-4L-084	×	①	R43-TE334D	非常用D/G (B) 固定子巻線温度 (U相) 検出器	③	06	蒸気発生器ブローダウン系	IV-BD-026A, B, C	ブローダウン C/V 外側隔離弁	④		
	3格納容器冷却却ドレンタンク薬液供給ライン格納容器第1隔離弁	3V-4L-094	×	①	R43-TE335A	非常用D/G (A) 固定子巻線温度 (V相) 検出器	③	06	機関入口ディーゼセル冷却水温度指示計	R43-T1051A	機関入口ディーゼセル冷却水温度指示計	④		
	3格納容器冷却却ドレンタンク出口格納容器第1隔離弁	3V-4L-042	×	②	R43-TE335B	非常用D/G (B) 固定子巻線温度 (V相) 検出器	③	06	機関出口ディーゼセル冷却水温度指示計 (接点付)	R43-T1051B	機関出口ディーゼセル冷却水温度指示計	④		
	3格納容器冷却却ドレンタンク出口格納容器第2隔離弁	3V-4L-043	×	①	R43-TE336A	非常用D/G (A) 固定子巻線温度 (W相) 検出器	③	06	機関出口ディーゼセル冷却水温度指示計 (接点付)	R43-T1S054B	機関出口ディーゼセル冷却水温度指示計	④		
	3格納容器サンプリングポンプ出口格納容器第1隔離弁	3V-4L-143	×	②	R43-TE336B	非常用D/G (B) 固定子巻線温度 (W相) 検出器	③	06	機関入口潤滑油温度指示計 (接点付)	R43-T1S100A	機関入口潤滑油温度指示計	④		
	3格納容器サンプリングポンプ出口格納容器第2隔離弁	3V-4L-144	×	①	R43-TE337A	非常用D/G (A) 固定子巻線温度 (U相) 検出器	③	06						
	3炉火水ライン格納容器隔離弁	3V-FS-502	×	①	R43-TE337B	非常用D/G (B) 固定子巻線温度 (U相) 検出器	③	06						
	3炉内圧計測装置ガスバーンライン格納容器第1隔離弁	3V-1G-009	×	②	R43-TE338A	非常用D/G (A) 固定子巻線温度 (V相) 検出器	③	06						
	3炉内圧計測装置ガスバーンライン格納容器第2隔離弁	3V-1G-008	×	①	R43-TE338B	非常用D/G (B) 固定子巻線温度 (V相) 検出器	③	06						
—	手動弁 一式		×	②	R43-TE339A	非常用D/G (A) 固定子巻線温度 (W相) 検出器	③	06						
	遮断弁 一式		×	②	R43-TE339B	非常用D/G (B) 固定子巻線温度 (W相) 検出器	③	06						
換気空調系	3換気空調機	3VB	○	—	R43-TE341A	非常用D/G (A) 軸受温度検出器	③	06						
	3A, 3B中央制御室空調ファン		○	—	R43-TE341B	非常用D/G (B) 軸受温度検出器	③	06						
	3A, 3B中央制御室循環ファン		○	—	R43-T1051A	機関入口ディーゼセル冷却水温度指示計	④	06						
	3A, 3B中央制御室非常用循環ファン	3VSP22A, B	○	—	R43-T1051B	機関出口ディーゼセル冷却水温度指示計	④	06						
	3A, 3B中央制御室外気取入止めダンパ	3D-VS-601A, B	×	①	R43-T1S054A	機関出口ディーゼセル冷却水温度指示計 (接点付)	④	06						
	3A, 3B中央制御室非常用循環ファン入口ダンパ	3D-VS-602A, B	○	—	R43-T1S054B	機関出口ディーゼセル冷却水温度指示計 (接点付)	④	06						
	3A, 3B中央制御室空調ファン出口ダンパ	3D-VS-603A, B	○	—	R43-T1S100A	機関入口潤滑油温度指示計 (接点付)	④	06						
	3A, 3B中央制御室循環ファン入口ダンパ	3D-VS-604A, B	○	—										
	3A, 3B中央制御室外気取入流量調節ダンパ	3KCD-2874, 2875	○	—										
	3A, 3B中央制御室循環流量調節ダンパ	3KCD-2885, 2886	○	—										
3A, 3B中央制御室大気放出流量調節ダンパ	3KCD-2887, 2888	×	①											
3A, 3B中央制御室事故時外気取入流量調節ダンパ	3KCD-2889, 2890	○	—											

※1 評価対象外とした理由
 ①溢水により機能を喪失しない
 ②PCV内前部電圧検出器の設置
 ③動作機能の喪失により安全機能に影響しない
 ④他の設備で代替できる

※1 評価対象外とした理由
 ①溢水により機能を喪失しない
 ②原子炉格納容器内前部電圧検出器の設置
 ③動作機能の喪失により安全機能に影響しない
 ④その他の設備で代替できる

赤字：設備、運用又は体制の相違（設計方針の相違）
 青字：記載箇所又は記載内容の相違（記載方針の相違）
 緑字：記載表現、設備名称の相違（実質的な相違なし）

第9条 溢水による損傷の防止等（別添1添付資料6）

大阪発電所3/4号炉					女川原子力発電所2号炉				泊発電所3号炉				相違理由
大阪3号炉防護対象設備のスクリーンアウト (7/10)					表2 溢水影響評価から対象外とした設備一覧 (7/24)				表2 溢水影響評価から対象外とした設備一覧 (7/9)				【大阪】 記載表現の相違 女川審査実績の反映 設計方針の相違 プラント設計の違いによる相違 【女川】 記載表現の相違 設計方針の相違 プラント設計の違いによる相違
系統	設備	番号	溢水影響 評価対象	スクリーンアウト の考え方	系統	機器番号	設備	理由 ^{※1}	系統	機器番号	機器名称	理由 ^{※1}	
換気空調系	3A,3B中央制御室事故時循環式換気調節ダンパ	3BFD-2891,2892	○	—	※1 評価対象外とした理由 ①溢水により機能喪失しない ②炉内前扉等仕様の設備 ③動作機能の喪失により安全機能に影響しない ④他の設備で代替できる	⑥ ⑦ ⑧ ⑨ ⑩ ⑪ ⑫ ⑬ ⑭ ⑮ ⑯ ⑰ ⑱ ⑲ ⑳ ㉑ ㉒ ㉓ ㉔ ㉕ ㉖ ㉗ ㉘ ㉙ ㉚ ㉛ ㉜ ㉝ ㉞ ㉟ ㊱ ㊲ ㊳ ㊴ ㊵ ㊶ ㊷ ㊸ ㊹ ㊺ ㊻ ㊼ ㊽ ㊾ ㊿ ㉿ ㊰ ㊱ ㊲ ㊳ ㊴ ㊵ ㊶ ㊷ ㊸ ㊹ ㊺ ㊻ ㊼ ㊽ ㊾ ㊿	① ① ② ③ ④ ⑤ ⑥ ⑦ ⑧ ⑨ ⑩ ⑪ ⑫ ⑬ ⑭ ⑮ ⑯ ⑰ ⑱ ⑲ ⑳ ㉑ ㉒ ㉓ ㉔ ㉕ ㉖ ㉗ ㉘ ㉙ ㉚ ㉛ ㉜ ㉝ ㉞ ㉟ ㊱ ㊲ ㊳ ㊴ ㊵ ㊶ ㊷ ㊸ ㊹ ㊺ ㊻ ㊼ ㊽ ㊾ ㊿ ㉿ ㊰ ㊱ ㊲ ㊳ ㊴ ㊵ ㊶ ㊷ ㊸ ㊹ ㊺ ㊻ ㊼ ㊽ ㊾ ㊿						
	3中央制御室風量(1),(2)	3FS-2908,2909	○	—				⑥ R43-TIS100B	機器入口潤滑油温度指示計(検点付)	⑥	① 3B-F	燃料取扱用ホット	①
	3A,3B中央制御室非常用循環ファン出口流量	3FS-2904,2905	○	—				⑦ R43-TIS343A	非常用D/G(A)軸受温度指示計(検点付)	⑦	3BFH1	燃料取扱用加水加熱器	①
	3A,3B中央制御室空調ファン出口流量	3FS-2910,2911	○	—				⑧ R43-TIS343B	非常用D/G(B)軸受温度指示計(検点付)	⑧	3F-1A-514A,B	制御用空気原子炉格納容器内供給弁	②
	34キックン排気(1),2隔離ダンパ	34F-505,506	○	—				⑨ R43-TS112A	潤滑油グライミングポンプ入口温度スイッチ	⑨	3F-VS-291A,B	燃料取扱機事故時排気ライン隔離ダンパ	③
	3A,3B中央制御室外気取入調節ダンパ流量設定	3BFC-2874,2875	○	—				⑩ R43-TS112B	潤滑油グライミングポンプ入口温度スイッチ	⑩	3FSA7A,B	アニュラス空気浄化フィルタユニット	①
	3A,3B中央制御室循環ダンパ流量設定	3BFC-2885,2886	○	—				PCS T49-4001A	FCS再結合器(A)	①	3F-VS-055	格納容器給気ライン格納容器外側隔離弁	③
	A,B中央制御室外気放出調節ダンパ流量設定	3BFC-2887,2888	○	—				PCS T49-4001B	FCS再結合器(B)	①	3F-VS-056	格納容器給気ライン格納容器内側隔離弁	②
	3A,3B中央制御室事故時外気取入調節ダンパ流量設定	3BFC-2889,2890	○	—				PCS T49-4001A	FCS冷却器(A)	①	3F-VS-061	格納容器排気ライン格納容器内側隔離弁	②
	3A,3B中央制御室事故時循環ダンパ流量設定	3BFC-2891,2892	○	—				PCS T49-4001B	FCS冷却器(B)	①	3F-VS-062	格納容器排気ライン格納容器外側隔離弁	③
	34A,3B安全補機閉閉器室空調ファン	34C-340	○	—				PCS T49-0001A	FCS再結合器(A)	①	3FSA18A,B	安全補機室冷却ユニット	①
	3安全系電気盤室給気止めダンパA,B	3D-VS-532,533	○	—				PCS T49-0001B	FCS再結合器(B)	①	3D-VS-301A,B	安全補機室給気第1隔離ダンパ	③
	3安全系電気盤室排気止めダンパA,B	3D-VS-536,537	○	—				PCS T49-0001A	FCS再結合器(A)	①	3D-VS-302A,B	安全補機室給気第2隔離ダンパ	③
	3A,3B安全補機閉閉器室温度	3TS-2817,2818	○	—				PCS T49-0001B	FCS再結合器(B)	①	3D-VS-303A,B	安全補機室排気第1隔離ダンパ	③
	3A,3B制御用空気圧縮機室給気ファン	3TS-2771,2772,2773,2774	○	—				PCS T49-TI001A	FCS(A)入口ガス温度検出器	②	3D-VS-304A,B	安全補機室排気第2隔離ダンパ	③
	3制御用空気圧縮機室温度(1),(2),(3),(4)	3TS-2771,2772,2773,2774	○	—				PCS T49-TI001B	FCS(B)入口ガス温度検出器	②	3D-VS-402A,B,C,D	ディーゼル発電機室排気ダンパ	①
	3制御用空気圧縮機室排気ダンパA,B	3D-VS-431A,B	○	—				PCS T49-TI009A-1	FCS再結合器(A)内ガス温度検出器	②	3FSG2A,B	原子炉建屋給気ガタリ	①
	3A,3B電動補助給水ポンプ室給気ファン	3D-VS-431A,B	○	—				PCS T49-TI009A-2	FCS再結合器(A)内ガス温度検出器	②	3FSM6A,B	安全補機閉閉器室給気ユニット	①
	3A,3B電動補助給水ポンプ室温度(1),(2)	3TS-2741,2742,2743,2744	○	—				PCS T49-TI009B-1	FCS再結合器(B)内ガス温度検出器	②			
	3電動補助給水ポンプ室排気ダンパA,B	3D-VS-411A,B	○	—				PCS T49-TI009B-2	FCS再結合器(B)内ガス温度検出器	②			
	3A1,3A2,3B1,3B2ディーゼル発電機室給気ファン	3TS-2791,2792,2793,2794,2711,2712,2713,2714	○	—				F1W R21-F052A	F1W第二隔離弁(A)	③			
	3A,3Bディーゼル発電機室温度(1),(2),(3),(4)	3TS-2791,2792,2793,2794,2711,2712,2713,2714	○	—				F1W R21-F052B	F1W第二隔離弁(B)	③			
	3Fディーゼル発電機室排気ダンパA1,A2,B1,B2	3D-VS-401A,B,402A,B	○	—				FPC F31	使用済燃料プール	①			
	3A,3B安全補機室冷却ファン	3TS-2880,2881,2890,2891	○	—				FPC 641-A001A	スキマサージタンク	①			
	3A,3Bほう酸ポンプ室空調ファン	3TS-2902,2903,2912,2913	○	—				FPC 641-A001B	スキマサージタンク	①			
	3A,3Bほう酸ポンプ室空調ファン給気加熱コイル	3FS-2904,2911	○	—				FPC 641-4001A	燃料プール冷却浄化系熱交換器(A)	①			
	3ほう酸タンク室温度(1),(2),(3),(4)	3TS-2902,2903,2912,2913	○	—				FPC 641-4001B	燃料プール冷却浄化系熱交換器(B)	①			
	3A,3Bアニュラス空気浄化ファン	3FSA7A,B	○	—				FPC 641-0006A	プール浄化水戻りデフューザ	①			
	アニュラス空気浄化フィルタユニット電気加熱コイル	3FSA18A,B	○	—				FPC 641-0006B	プール浄化水戻りデフューザ	①			
	3A,3Bアニュラス排気ダンパ	3D-VS-101A,B	○	—				FPC 641-3013	F1PCラベ風機装置出口弁	②			

赤字：設備、運用又は体制の相違（設計方針の相違）
 青字：記載箇所又は記載内容の相違（記載方針の相違）
 緑字：記載表現、設備名称の相違（実質的な相違なし）

第9条 溢水による損傷の防止等（別添1添付資料6）

大阪発電所3/4号炉					女川原子力発電所2号炉					泊発電所3号炉					相違理由
大阪3号炉防護対象設備のスクリーンアウト (8/10)					表2 溢水影響評価から対象外とした設備一覧 (8/24)					表2 溢水影響評価から対象外とした設備一覧 (8/9)					【大阪】 記載表現の相違 女川審査実績の反映 設計方針の相違 プラント設計の違いによる相違 【女川】 記載表現の相違 設計方針の相違 プラント設計の違いによる相違
系統	設備	番号	溢水影響 評価対象	スクリーンアウト の考え方	系統	機器番号	設備	理由①	系統	機器番号	機器名称	理由②			
換気空調系	3A, 3Bアニュラス吸りダンパ	3D-Y5-104A, B	○	—	FPC	641-TS016	燃料貯蔵プール水位スイッチ	③	換気空調系	3VS44A, B	中央制御室給気ユニット	①			
	3A, 3Bアニュラス全量排気弁	3V-Y5-102A, B	○	—	FPC	641-P1006	F P C ポンプ出口圧力指示計	③	換気空調系	3D-Y5-601A, B	中央制御室外気取入ダンパ	③			
	3A, 3Bアニュラス少量排気弁	3V-Y5-103A, B	○	—	FPC	641-TB001	F P C ポンプ入口温度検出器	③	換気空調系	3D-Y5-611, 612	中央制御室排気第1 (2) 隔離ダンパ	③			
	3A, 3Bアニュラス圧力制御器	3W-2522, 2542	×	①	FPC	641-TS014A	F P C 熱交換器 (A) 出口温度検出器	③	換気空調系	3HCD-2838, 2839	中央制御室排気風量調節ダンパ	③			
	3A, 3B格納容器排気ファン出口ダンパ	3D-Y5-660A, B	×	①	FPC	641-TS014B	F P C 熱交換器 (B) 出口温度検出器	③	換気空調系	3VS8	中央制御室非常用扇風機フィルタユニット	①			
	3格納容器排気止めダンパ	3D-Y5-041	×	①	FPC	641-TB015	燃料貯蔵プール水温度	③	換気空調系	3D-Y5-053	格納容器給気密閉ダンパ	③			
	3補助送風排気流量調節ダンパ	3HCD-2760	×	①	FPMU	P15-P1001	F P M U W ポンプ入口圧力	③	換気空調系	3D-Y5-064	格納容器排気密閉ダンパ	③			
	3補助送風排気止めダンパ	3D-Y5-351	×	①	FPMU	P15-P1004	F P M U W ポンプ出口圧力	③	換気空調系	3D-Y5-065A, B	格納容器排気ファン出口ダンパ	③			
	3放射線管理室排気流量調節ダンパ	3HCD-2976	×	①	FPMU	P15-P1001	F P M U W ポンプ入口圧力	③	換気空調系	3D-Y5-232	補助送風排気隔離ダンパ	③			
	3放射線管理室排気止めダンパ	3HCD-4658	×	①	FPMU	P15-P1004	F P M U W ポンプ出口圧力	③	換気空調系	3HCD-2526	補助送風排気流量調節ダンパ	③			
	3A, 3B安全備極室排気ダンパ	3D-Y5-105A, B	○	—	HECW	P25-3002A	換気空調種機非常用冷却水系サージタンク (A)	①	空調用冷水系	3CH1	空調用冷水貯留タンク	①			
	3安全備極室排気第1, 2隔離ダンパ	3D-Y5-301, 302	×	①	HECW	P25-3002B	換気空調種機非常用冷却水系サージタンク (B)	①	木消火系	3V-FS-504	消火水 C/V 外側隔離弁	③			
	3安全備極室排気第1, 2隔離ダンパ	3D-Y5-303, 304	×	①	HECW	P25-P007A	中央制御室給気冷卻コイル (A) 温度調節弁	③	炉内核計装置 置ガスバージ 設備系	3V-IG-008	炉内核計装置置二酸化炭素バージライン C/V 外側隔離弁	③			
	3アニュラス給気第1, 2隔離ダンパ	3D-Y5-052, 053	×	①	HECW	P25-P007B	中央制御室給気冷卻コイル (B) 温度調節弁	③	炉内核計装置 置ガスバージ 設備系	3V-IG-009	炉内核計装置置二酸化炭素バージライン C/V 内側隔離弁	③			
	3アニュラス排気第1, 2隔離ダンパ	3D-Y5-058, 059	×	①	HECW	P25-P018A	計測制御電源 (A) 室給気冷卻コイル温度調節弁	③	原子炉格納容 器真空逃がし 装置系	3V-VK-001A, B	真空逃がし装置 C/V 外側隔離弁	③			
	3格納容器給気第2隔離弁	3V-Y5-054	×	①	HECW	P25-P018B	計測制御電源 (B) 室給気冷卻コイル温度調節弁	③	非常用 電源系	3DG1A, B	ディーゼル発電機燃料油貯油槽	①			
	3格納容器給気第1隔離弁	3V-Y5-055	×	②	HECW	P25-P024A	原子炉補機 (A) 室給気冷卻コイル温度調節弁	③	非常用 電源系	3DG2A, B	ディーゼル発電機燃料油サービスタンク	①			
	3格納容器給気第1隔離弁	3V-Y5-056	×	②	HECW	P25-P024B	原子炉補機 (B) 室給気冷卻コイル温度調節弁	③							
	3格納容器排気第2隔離弁	3V-Y5-057	×	①	HECW	P25-LS011A	HE C W サージタンク (A) 水位スイッチ	③							
	3A, 3B安全備極室冷卻ファン現場操作箱	3LB-82, 83	○	—	HECW	P25-LS011B	HE C W サージタンク (B) 水位スイッチ	③							
	3A1・A2, 3B1・B2ディーゼル発電機室給気ファン現場操作箱	3LB-84, 85	○	—	HECW	P25-P1001A	HE C W 冷水ポンプ (A) 出口圧力	③							
	3A, 3B電機排気給水ポンプ室給気ファン現場操作箱	3LB-86, 87	○	—	HECW	P25-P1001B	HE C W 冷水ポンプ (B) 出口圧力	③							
	3A, 3B制御用空気圧縮機室給気ファン現場操作箱	3LB-90, 91	○	—	HECW	P25-P1001C	HE C W 冷水ポンプ (C) 出口圧力	③							
	3A, 3B中央制御室循環ファン現場操作箱	3LB-95, 96	○	—	HECW	P25-P1001D	HE C W 冷水ポンプ (D) 出口圧力	③							
	3A, 3B中央制御室空調ファン現場操作箱	3LB-101, 102	○	—	HECW	P25-P1007A	HE C W 冷水ポンプ (A) 入口圧力	③							
	3A4, 3B4, 3C4, 3D4安全備極室空調ファン現場操作箱	3ALB-13, 14, 20, 21	○	—	HECW	P25-P1007B	HE C W 冷水ポンプ (B) 入口圧力	③							
	3A, 3Bほう電ポンプ室空調ファン現場操作箱	3LB-77, 78	○	—	HECW	P25-P1007C	HE C W 冷水ポンプ (C) 入口圧力	③							
	3A, 3Bアニュラス空気浄化ファン現場操作箱	3LB-82, 83	○	—	HECW	P25-P1007D	HE C W 冷水ポンプ (D) 入口圧力	③							
	3A, 3B中央制御室非常用循環ファン現場操作箱	3LB-97, 98	○	—											
	3空調用冷水貯留タンク			×	③										
	3A, 3B, 3C, 3D空調用冷水槽			○	—										
	3A, 3B, 3C, 3D空調用冷水ポンプ			○	—										
	3A, 3B, 3C, 3D安全備極室空調ユニット冷水温度制御弁	3HCV-2800, 2801	○	—											
3A, 3B中央制御室空調ユニット冷水温度制御弁	3TCV-2878, 2879	○	—												

※1 評価対象外とした理由
 ①溢水により機能を喪失しない
 ②炉内前環境比検の設備
 ③動作機能の喪失により安全機能に影響しない
 ④他の設備で代替できる

※1 評価対象外とした理由

- ①溢水により機能を喪失しない
- ②炉内前環境比検の設備
- ③動作機能の喪失により安全機能に影響しない
- ④他の設備で代替できる

赤字：設備、運用又は体制の相違（設計方針の相違）
 青字：記載箇所又は記載内容の相違（記載方針の相違）
 緑字：記載表現、設備名称の相違（実質的な相違なし）

大阪発電所3/4号炉					女川原子力発電所2号炉			泊発電所3号炉			相違理由		
大阪3号炉防護対象設備のスクリーンアウト (9/10)					表2 溢水影響評価から対象外とした設備一覧 (9/24)			表2 溢水影響評価から対象外とした設備一覧 (9/9)			【大阪】		
系統	設備	番号	溢水影響 評価対象	スクリーンアウト の考え方	系統	機器番号	設備	理由*	系統	機器番号	機器名称	理由*	
冷水系	3号炉用冷水Nヘッダ供給、戻りライン本配	3V-CR-002, 003	○	—	HPCV	F24-F102	HNCW供給ライン第二隔離弁	④	関連設備	3NE41A, B, 3NE42A, B, 3NE43A, B, 3NE44A, B	出力領域検出器	②	
	3号炉非配管保安冷却ユニット冷水入口、 出口格納容器隔離弁	3V-CR-403, 407	×	①	HPCV	F24-F107	HNCW戻りライン第一隔離弁	②		関連設備	3NE31, 32	中性子源領域検出器	②
	3A, 3B, 3C, 3D空調用冷水ポンプ現用機作動 装置1台隔離弁	3A, B-103, 104, 105, 106	○	—	HPCS	E22-0010	高圧炉心スプレイズシステムレーナ	①			関連設備	3RE-91A, 92A	格納容器高レンジエリアモニタ (低レンジ)
3A, 3B格納容器減圧装置排気ライン格納容 器装置1台隔離弁	3V-DR-001A, B	×	②	HPCS	E22-dP1006	HPCSノズル差圧伝送器	③	関連設備	3RE-91B, 92B		格納容器高レンジエリアモニタ (高レンジ)	②	
格納容器減圧系 及び水素制御設 備系	3A, 3B格納容器減圧装置排気ライン格納容 器装置1台隔離弁	3V-DR-002A, B	×	①	HPCS	E22-F1010	HPCS S/C相対機用調整弁	③	—	—	手動弁一式	①	
	3A, 3B格納容器本系バーン結露ライン格納 容器装置1台隔離弁	3V-DR-309A, B	×	①	HPCS	E22-F021	HPCS注入ライン試験可能逆止弁均圧弁	②	—	—	逆止弁一式	①	
	3A, 3B格納容器本系バーン結露ライン格納 容器装置1台隔離弁	3V-DR-309A, B	×	①	HPCS	E22-F1005B	HPCSボンプ出口流量変換器	③	—	—	逆止弁一式	①	
放射線監視設備 空気サンプリン グシステム	3号炉格納容器サンプル取り出しライン格納容 器装置1台隔離弁	3V-DR-001	×	②	HPCS	E22-P1001	HPCSボンプ入口圧力	③	—	—	配管一式	①	
	3号炉格納容器サンプル取り出しライン格納容 器装置1台隔離弁	3V-DR-002	×	①	HPCS	E22-P1004	HPCSボンプ出口圧力	③	*1 評価対象外とした理由 ①溢水により機能を喪失しない ②原子が格納容器内環境に仕舞の設備 ③動作機種の喪失により安全機能に影響しない ④その他の設備で代替できる				
	3号炉格納容器サンプル取り出しライン格納容 器装置1台隔離弁	3V-DR-013	×	①	HPCS	E22-P1004	HPCSボンプ出口圧力	③					
3号炉格納容器サンプル取り出しライン格納容 器装置1台隔離弁	3V-DR-013	×	①	HPCS	E22-F1001A	HPCSボンプ入口圧力伝送器	③						
電気盤	3主盤 (原子炉盤)	3MCD	○	—	HPSDG	R44-A001	潤滑油ポンク	①	HPSDG	R44-A102	潤滑油補給タンク	①	
	3原子炉安全保護計装盤1, II, III, IV	3RPP-1, II, III, IV	○	—	HPSDG	R44-A102	潤滑油補給タンク	①	HPSDG	R44-A200	軽油タンク (G)	①	
	3A, 3B, 3C, 3D原子炉安全保護ロジック盤	3RPL-A, B, C, D	○	—	HPSDG	R44-A201	燃料ディタンク	①	HPSDG	R44-A300	空気だめ (自動)	①	
	3安全保護シーケンス盤601, 602, 601, 602	3SPS-A1, A2, B1, B2	○	—	HPSDG	R44-B001	潤滑油冷却器	①	HPSDG	R44-B003	機関付空気冷却器	①	
	3A1, 3A2, 3A3, 3A4, 3B1, 3B2, 3B3, 3B4ゾレ イ上分電盤	3SD-A1, A2, A3, A1 B1, B2, B3, B4	○	—	HPSDG	R44-B100	潤滑油冷却器	①	HPSDG	R44-B102	発電機軸受潤滑油冷却器	①	
	3原子炉トリップ遮断装置	3RCS	○	—	HPSDG	R44-D100	機関付潤滑油フィルタ	①	HPSDG	R44-D200	燃料移送ポンプ入口ストレーナ	①	
	3A, 3Bドロップ盤	3RCP-A, DRP, 3BC-B, DRP	○	—	HPSDG	R44-D201	HPCS S-D/G燃料移送ポンプ出口フィルタ	①	HPSDG	R44-D202-1	燃料油フィルタ-1	①	
	3A, 3B直流充電盤	3RDP-A, B	○	—	HPSDG	R44-D202-2	燃料油フィルタ-2	①	HPSDG	R44-D300	船舶用空気Y型ストレーナ	①	
	3A, 3B直流分電盤	3RDP-A, B	○	—	HPSDG	R44-D301	船舶用空気Y型ストレーナ	①	HPSDG	R44-dPS112	機関付潤滑油フィルタ連圧	③	
	3A, 3B蓄電池	3RCP-A, B	○	—									
	3A, 3B充電器	3RCP-A, B	○	—									
	3A1, 3A2, 3B1, 3B2メタルクラッドスイッチ ギヤ	3RC-A1, A2, B1, B2	○	—									
	3A1, 3A2, 3B1, 3B2パワーセンター	3PC-A1, A2, B1, B2	○	—									
	3A1, 3A2, 3B1, 3B2原子炉コントロールセン タ	3RCC-A1, A2, B1, B2	○	—									
	3A, 3B, 3C, 3D計装用電線盤 (1)~(3)	3IRC-A, B, C, D	○	—									
	3A1, 3A2, 3B1, 3B2, 3C1, 3C2, 3B1, 3B2計装用 分電盤	3IRP-A1, A2, B1, B2 C1, C2, B1, B2	○	—									
	3A, 3B, 3C, 3D計装用交流電源切替盤	3ISP-A, B, C, D	○	—									
	3炉内盤	3IBS	○	—									
	3AC, 3DC計装用後備分電盤	3IBD-AC, DC	○	—									
	3事故時放射線監視	3RMS-III, IV	○	—									
	計器	3R1力領域中性子束	3V-A1, 42, 43, 44	×	②								
						*1 評価対象外とした理由 ①溢水により機能を喪失しない ②炉内環境仕舞の設備 ③動作機種の喪失により安全機能に影響しない ④他の設備で代替できる							

赤字：設備、運用又は体制の相違（設計方針の相違）
 青字：記載箇所又は記載内容の相違（記載方針の相違）
 緑字：記載表現、設備名称の相違（実質的な相違なし）

第9条 溢水による損傷の防止等（別添1添付資料6）

大阪発電所3/4号炉					女川原子力発電所2号炉				泊発電所3号炉	相違理由
大阪3号炉防護対象設備のスクリーンアウト (10/10)					表2 溢水影響評価から対象外とした設備一覧 (10/24)					
系統	設備	番号	溢水影響評価対象	スクリーンアウトの考え方	系統	機器番号	設備	理由 ^{※1}		
計器	3中性線領域中性子束	3N-31,32	×	②	HPVSDG	R44-1FS210	燃料前フィルタ差圧スイッチ	③	<p>【大阪】</p> <p>記載表現の相違</p> <p>女川審査実績の反映</p> <p>設計方針の相違</p> <p>プラント設計の違いによる相違</p> <p>【女川】</p> <p>記載表現の相違</p> <p>設計方針の相違</p> <p>プラント設計の違いによる相違</p>	
	3格納容器高レベルアラームタ(此レンジ)・(高レベル)	3RE-91A, 91B, 92A, 92B	×	②	HPVSDG	R44-2200	フレンチバルブチューブ	①		
	3A, 3Bディーゼル機関		○	—	HPVSDG	R44-1S050	消水膨脹タンク水位指示計（接点付）	③		
	3A, 3Bディーゼル発電機		○	—	HPVSDG	R44-1S257	シリンドラ段水スイッチ	③		
非常用電源系	3A, 3Bディーゼル発電機コントロールセンサ	300C-A,B	○	—	HPVSDG	R44-1052	機関待機水ポンプ出口圧力	③		
	3A, 3Bディーゼル発電機制御装置	300C-A,B	○	—	HPVSDG	R44-1102	機関待機消油ポンプ出口圧力指示計	③		
					HPVSDG	R44-11202	燃料缶ストレート前後圧力指示計	③		
					HPVSDG	R44-11203	燃料移送ポンプ出口圧力指示計	③		
				HPVSDG	R44-11211	機関入口燃料油圧力指示計	③			
				HPVSDG	R44-11256	機関入口暖気圧力指示計	③			
				HPVSDG	R44-11S108	潤滑油プライミングポンプ出口圧力指示計（接点付）	③			
				HPVSDG	R44-11S113	機関入口潤滑油圧力	③			
				HPVSDG	R44-11S253	空気だめ圧力（自動）指示計（接点付）	③			
				HPVSDG	R44-10S200	燃料ハンドル位置異常スイッチ	③			
				HPVSDG	R44-10S202	ターニングハンドル位置異常スイッチ	③			
				HPVSDG	R44-18250	空気だめ圧力（自動）スイッチ	③			
				HPVSDG	R44-18251	空気だめ圧力（自動）スイッチ	③			
				HPVSDG	R44-1E301E	H P C S D / G 固定子巻線温度 (U相) 検出器	③			
				HPVSDG	R44-1E302E	H P C S D / G 固定子巻線温度 (V相) 検出器	③			
				HPVSDG	R44-1E303E	H P C S D / G 固定子巻線温度 (W相) 検出器	③			
				HPVSDG	R44-1E304E	H P C S D / G 固定子巻線温度 (U相) 検出器	③			
				HPVSDG	R44-1E305E	H P C S D / G 固定子巻線温度 (V相) 検出器	③			
				HPVSDG	R44-1E306E	H P C S D / G 固定子巻線温度 (W相) 検出器	③			
				HPVSDG	R44-1E307E	H P C S D / G 固定子巻線温度 (U相予備) 検出器	③			
				HPVSDG	R44-1E308E	H P C S D / G 固定子巻線温度 (V相予備) 検出器	③			
				HPVSDG	R44-1E309E	H P C S D / G 固定子巻線温度 (W相予備) 検出器	③			
				HPVSDG	R44-1E341E	H P C S D / G 反直結軸軸受温度検出器	③			
<p>スクリーンアウトの考え方</p> <p>①プラント停止操作時に動作要求のない電動弁及び動作機能喪失によりフェイルポジションとなる空気作動弁並びに安全弁は機能喪失しても安全機能に影響ない（動作要求のない原子炉格納容器格納容器破砕弁を含む）。</p> <p>②原子炉格納容器内の防護対象装置は温度、圧力条件及び溢水影響を考慮した制御装置であるため機能喪失しない。又は、溢水事故が発生した場合のプラント停止操作において必ずしも必要でないもの。</p> <p>③タンク、熱交換器、逆止弁、手動弁等の静的機器は溢水により機能喪失しない。</p> <p>④他の設備で代替できる。</p>					<p>※1 評価対象とした理由</p> <p>①溢水により機能を喪失しない</p> <p>②PCV内耐腐蝕仕様設備</p> <p>③動作機能の喪失により安全機能に影響しない</p> <p>④他の設備で代替できる</p>					

赤字：設備、運用又は体制の相違（設計方針の相違）
 青字：記載箇所又は記載内容の相違（記載方針の相違）
 緑字：記載表現、設備名称の相違（実質的な相違なし）

第9条 溢水による損傷の防止等（別添1添付資料6）

大阪発電所3/4号炉				女川原子力発電所2号炉				泊発電所3号炉				相違理由	
大阪4号炉防護対象設備のスクリーンアウト (1/10)				表2 溢水影響評価から対象外とした設備一覧 (11/24)									
系統	設備	番号	溢水影響 評価対象	スクリーンアウト の考え方	系統	機器番号	設備	理由					
1次冷却系	4原子炉容器		×	②	HPSSDG	R44-TF342H	H P C S D / G 直結軸受温度検出器	③				【大阪】 記載表現の相違 女川審査実績の反映 設計方針の相違 プラント設計の違いによる相違 【女川】 記載表現の相違 設計方針の相違 プラント設計の違いによる相違	
	4A, 4B, 4C, 4D 40蒸気発生器		×	②	HPSSDG	R44-TF1051	機関入口グリースル冷却水温度指示計	③					
	4A, 4B, 4C, 4D-1次冷却材ポンプ		×	①	HPSSDG	R44-TL103	機関出口潤滑油温度指示計	③					
	4加圧器		×	②	HPSSDG	R44-TS064	機関出口グリースル冷却水温度指示計（検点付）	③					
	4A, 4B, 4C加圧器安全弁	4V-KC-055, 056, 057		×	②	HPSSDG	R44-TS111	機関潤滑油温度	③				
	4A, 4B加圧器過熱し弁	4PCV-452A, B		×	②	HPSSDG	R44-TS343H	H P C S D / G 直結軸受温度指示計（検点付）	③				
	4A, 4B加圧器過熱し弁前弁	4V-KC-084A, B		×	①	HPSSDG	R44-TS344H	H P C S D / G 直結軸受温度指示計（検点付）	③				
	4加圧器過熱しタンクガス分析ライン格納容器非-隔離弁	4V-KC-077		×	②	HPSSDG	R44-TS107	潤滑油グライミングポンプ入口圧力スイッチ	③				
	4加圧器過熱しタンクガス分析ライン格納容器非-隔離弁	4V-KC-078		×	①	HPSSDG	R44-TS107	潤滑油グライミングポンプ入口圧力スイッチ	③				
	4加圧器過熱しタンクガス分析ライン格納容器隔離弁	4V-KC-084		×	①	HPSSDG	R44-TS107	潤滑油グライミングポンプ入口圧力スイッチ	③				
	4格納容器内補給水供給ライン格納容器隔離弁	4V-KC-096		×	①	HPCW	PM7-4001	高圧炉心スプレッド補機冷却水サージタンク	①				
	4A, 4B加圧器スプレイ弁	4PCV-451A, B		×	①	HPCW	PM7-3001	高圧炉心スプレッド補機冷却水蒸気交換器	①				
	F-1次冷却材圧力	4PT-420, 430		×	②	HPCW	PM7-L1007	H P C W サージタンク水位	②				
	4加圧器水位	4LT-401, 402, 403, 404		×	②	HPCW	PM7-P1001	H P C W ポンプ出口圧力	③				
	4A, B, C, Dグループ1次冷却材高流量・低流量測定（広域）	4TF-410, 410, 420, 425, 430, 435, 440, 445		×	②	HPCW	PM7-P1005	H P C W ポンプ入口圧力	③				
	4A, B, C, Dグループ1次冷却材高流量・低流量測定（狭域）	4TF-411A, 411B, 411C, 411D, 421A, 421B, 421C, 421D, 431A, 431B, 431C, 431D, 441A, 441B, 441C, 441D		×	②	HPCW	PM7-P7004	H P C W 冷却水供給圧力伝送器	③				
	4加圧器圧力	4PT-401, 402, 403, 404		×	②	HPCW	PM7-T2003	H P C W 冷却水供給温度検出器	③				
	4A, B, C, Dグループ1次冷却材流量	4TF-412, 413, 414, 415, 422, 423, 424, 425, 432, 433, 434, 435, 442, 443, 444, 445		×	②	HPSW	PM8-3001A	高圧炉心スプレッド補機冷却水系ストレーナ（A）	①				
	1次冷却材ポンプ回転数	4SE-410A, 420A, 430A, 440A		×	②	HPSW	PM8-3001B	高圧炉心スプレッド補機冷却水系ストレーナ（B）	①				
	化学体積制御系	4A, 4Bほう酸ポンプ		○	—	HPSW	PM8-SP1002	H P S W ストレーナ圧力指示計	③				
		4A, 4B, 4C充てんポンプ		○	—	HPSW	PM8-P7001	H P S W ポンプ出口圧力	③				
		4体積制御タンク		×	①	HPSW	PM8-P7001	H P S W ポンプ出口圧力伝送器	③				
		4再生熱交換器		×	②			排気筒	①				
		4A, 4Bほう酸タンク		×	①								
4ほう酸フィルタ			×	①									
4排水冷却器			×	①									
4A, 4B排水注入フィルタ			×	①									
4排水ストレーナ			×	①									
4体積制御タンク出口第1止め弁		4LCV-321B		○	—	HPAC	V10-3201A	C A M S （A） 室非常用給気隔離ダンパ	④				
4体積制御タンク出口第2止め弁		4LCV-321C		○	—	HPAC	V10-3201B	C A M S （B） 室非常用給気隔離ダンパ	④				
4緊急ほう酸注入ライン継ぎ弁		4V-CS-373		○	—	HPAC	V10-3202A	C A M S （A） 室非常用排気隔離ダンパ	④				
					HPAC	V10-3202B	C A M S （B） 室非常用排気隔離ダンパ	④					
					HPAC	V10-3203	D C -M C C 2 A 室非常用給気隔離ダンパ	④					

※1 評価対象外とした理由
 ① 溢水により機能を喪失しない
 ② PCV内耐腐蝕性仕様の設備
 ③ 動作機能の喪失により安全機能に影響しない
 ④ 他の設備で代替できる

赤字：設備、運用又は体制の相違（設計方針の相違）
 青字：記載箇所又は記載内容の相違（記載方針の相違）
 緑字：記載表現、設備名称の相違（実質的な相違なし）

第9条 溢水による損傷の防止等（別添1添付資料6）

大阪発電所3/4号炉					女川原子力発電所2号炉					泊発電所3号炉					相違理由					
大阪4号炉防護対象設備のスクリーンアウト (2/10)					表2 溢水影響評価から対象外とした設備一覧 (12/24)															
系統	設備	番号	溢水影響 評価対象	スクリーンアウト の考え方	系統	機器番号	設備	理由 ^{※1}	系統	機器番号	設備	理由 ^{※1}								
化学体制制御系	圧てんポンプ入口燃料取扱用ホットプレート注水	4CY-121B,E	○	—	IVAC	V10-9204	D/C-MCC 2A変圧用排気隔離ダンパ	㊸	【大阪】 記載表現の相違 女川審査実績の反映 設計方針の相違 プラント設計の違いによる相違 【女川】 記載表現の相違 設計方針の相違 プラント設計の違いによる相違											
	圧てんライン格納容器隔離弁	IV-CS-157	○	—	IVAC	V10-F901A	原子炉種排気隔離弁（A）用アキュムレータ	㊸												
	圧てんライン止め弁	IV-CS-155	○	—	IVAC	V10-F901A	原子炉種排気隔離弁（A）	㊸												
	圧てんライン流量制御弁	4FCY-138	×	㊸	IVAC	V10-F901B	原子炉種排気隔離弁（B）用アキュムレータ	㊸												
	1次冷却材ポンプ封水注入ライン流量制御弁	4FCY-140	×	㊸	IVAC	V10-F901B	原子炉種排気隔離弁（B）	㊸												
	抽出ライン第1止め弁	4CY-451	×	㊸	IVAC	V10-F902A	原子炉種排気隔離弁（A）用アキュムレータ	㊸												
	抽出ライン第2止め弁	4CY-452	×	㊸	IVAC	V10-F902A	原子炉種排気隔離弁（A）	㊸												
	IA、IB、IC抽出リフライアス出口格納容器第1隔離弁	4V-CS-004A,B,C	×	㊸	IVAC	V10-F902B	原子炉種排気隔離弁（B）用アキュムレータ	㊸												
	III圧格納容器スプレイ弁	4V-CS-169	×	㊸	IVAC	V10-F902B	原子炉種排気隔離弁（B）	㊸												
	圧てん抽出ライン第1止め弁	4V-CS-301	×	㊸	IVAC	V10-F922A	原子炉種排気隔離弁（A）用アキュムレータ（電磁弁）	㊸												
	圧てん抽出ライン第2止め弁	4V-CS-302	×	㊸	IVAC	V10-F922B	原子炉種排気隔離弁（B）用アキュムレータ（電磁弁）	㊸												
	抽出ライン格納容器第2隔離弁	4V-CS-007	×	㊸	IVAC	V10-F530A	原子炉種排気隔離弁（A）用アキュムレータ（電磁弁）	㊸												
	圧てんライン流量制御弁前止め弁	4V-CS-151	×	㊸	IVAC	V10-F530B	原子炉種排気隔離弁（B）用アキュムレータ（電磁弁）	㊸												
	IIIループ圧てんライン止め弁	4V-CS-163	×	㊸	IVAC	V10-F15015A	原子炉種排気隔離弁（A）用アキュムレータ圧力	㊸												
	1次冷却材ポンプ封水注入ライン流量制御弁前止め弁	4V-CS-177	×	㊸	IVAC	V10-F15015B	原子炉種排気隔離弁（B）用アキュムレータ圧力	㊸												
	IA、IB、IC、4B-1次冷却材ポンプ封水注入ライン流量制御弁	4V-CS-190A,B,C,D	×	㊸	IVAC	V10-F15016A	原子炉種排気隔離弁（A）用アキュムレータ圧力	㊸												
	1次冷却材ポンプ封水戻りライン格納容器第1隔離弁	4V-CS-310	×	㊸	IVAC	V10-F15016B	原子炉種排気隔離弁（B）用アキュムレータ圧力	㊸												
	1次冷却材ポンプ封水戻りライン格納容器第2隔離弁	4V-CS-312	○	—	IVAC	V11-9001	原子炉補機（A）供給気冷却コイル	㊸												
	IA、IB、IC、4B-1次冷却材ポンプ封水戻りライン止め弁	4V-CS-208A,B,C,D	×	㊸	IVAC	V11-9001	原子炉補機（A）供給気バッグエアフィルタ	㊸												
	IA、IB、IC、4B-1次冷却材ポンプ封水戻りライン止め弁	4LT-206,208	○	—	IVAC	V11-9002	D/G（A）供給気バッグエアフィルタ	㊸												
	圧てんポンプ速度制御装置	4VSC	○	—	IVAC	V11-4P1001	D/G（A）供給気バッグエアフィルタ差圧指示計	㊸												
	圧てんポンプ速度制御補助装置	4VSAC	○	—	IVAC	V11-4P1003	D/G（A）供給気バッグエアフィルタ差圧指示計	㊸												
	IA、IB、IC、4B-1次冷却材ポンプ現場操作箱	4LB-5,6,7,9	○	—	IVAC	V11-2901	原子炉補機（A）供給気ループ	㊸												
	IA、IB、IC、4B-1次冷却材ポンプ現場操作箱	4LB-9,10	○	—	IVAC	V11-2902	原子炉補機（A）供給気ループ	㊸												
	IA、IB、IC、4B-1次冷却材ポンプ現場操作箱	4LB-5,6,7,9	○	—	IVAC	V11-2903	D/G（A）供給気ループ	㊸												
	IA、IB、IC、4B-1次冷却材ポンプ現場操作箱	4LB-9,10	○	—	IVAC	V11-2904	D/G（A）供給気ループ	㊸												
	安全注入系	IA、IB、IC、4B-1次冷却材ポンプ現場操作箱	4V-SI-015A,B	○	—	IVAC	V11-5002	D/G（A）供給気ループ							㊸					
		IA、IB、IC、4B-1次冷却材ポンプ現場操作箱	4V-SI-010A,B	○	—	IVAC	V11-5003	D/G（A）供給気ループ							㊸					
		IA、IB、IC、4B-1次冷却材ポンプ現場操作箱	4V-SI-093A,B	○	—	IVAC	V11-5004	D/G（A）供給気ループ							㊸					
		IA、IB、IC、4B-1次冷却材ポンプ現場操作箱	4V-SI-092A,B	○	—	IVAC	V11-5005	D/G（A）供給気ループ							㊸					
		IA、IB、IC、4B-1次冷却材ポンプ現場操作箱	4V-SI-096A,B	○	—	IVAC	V11-5006	D/G（A）供給気ループ							㊸					
		IA、IB、IC、4B-1次冷却材ポンプ現場操作箱	4V-SI-092A,B	×	㊸	IVAC	V11-5007	D/G（A）供給気ループ							㊸					
		IA、IB、IC、4B-1次冷却材ポンプ現場操作箱	4V-SI-096A,B	×	㊸	IVAC	V11-5008	D/G（A）供給気ループ							㊸					
		IA、IB、IC、4B-1次冷却材ポンプ現場操作箱	4V-SI-096A,B	×	㊸	IVAC	V11-5009	D/G（A）供給気ループ							㊸					
		IA、IB、IC、4B-1次冷却材ポンプ現場操作箱	4V-SI-097A,B	×	㊸	IVAC	V11-5010	D/G（A）供給気ループ							㊸					
		IA、IB、IC、4B-1次冷却材ポンプ現場操作箱	4V-SI-097A,B	×	㊸	IVAC	V11-5011	D/G（A）供給気ループ							㊸					

※1 評価対象外とした理由
 ①従来より機能を喪失しない
 ②PCV内耐事故仕様設備
 ③動作機能の喪失により安全機能に影響しない
 ④他の設備で代替できる

赤字：設備、運用又は体制の相違（設計方針の相違）
 青字：記載箇所又は記載内容の相違（記載方針の相違）
 緑字：記載表現、設備名称の相違（実質的な相違なし）

第9条 溢水による損傷の防止等（別添1添付資料6）

大阪発電所3/4号炉						女川原子力発電所2号炉				泊発電所3号炉		相違理由
大阪4号炉防護対象設備のスクリーンアウト（3/10）						表2 溢水影響評価から対象外とした設備一覧（13/24）						
系統	設備	番号	溢水影響評価対象	スクリーンアウトの考え方		系統	機器番号	設備	理由 ^{※1}			
安全注入系	IA, IB, IC, 40超圧タンク出口弁	4F-S1-122A, B, C, D	×	②		HVAC	V12-4001	原子炉補機（B） 窒素気冷却コイル	①		【大阪】 記載表現の相違 女川審査実績の反映 設計方針の相違 プラント設計の違いによる相違 【女川】 記載表現の相違 設計方針の相違 プラント設計の違いによる相違	
	4格納容器再循環ポンプ本流（戻線）（圧縮機）	4LT-976, 971, 972, 973	×	②		HVAC	V12-4002	原子炉補機（B） 窒素気加熱コイル	①			
	IA, 40高圧注入ポンプ現場操作箱	4IB-12, 13	○	—		HVAC	V12-4001	原子炉補機（B） 窒素気バッグエアフィルタ	①			
	燃料取扱用排水ピット水位1, II, III, IV	4LT-1400, 1401, 1402, 1403	○	—		HVAC	V12-4002	D/G（B） 窒素気バッグエアフィルタ	①			
	40高圧注入流量（I）, 40高圧注入流量（II）	4FT-962, 963	○	—		HVAC	V12-4P1001	原子炉補機（B） 窒素気バッグエアフィルタ差圧指示計	②			
余熱除去系	IA, 40余熱除去ポンプ		○	—		HVAC	V12-4P1003	D/G（B） 窒素気バッグエアフィルタ差圧指示計	③			
	IA, 40余熱除去ポンプミキシングフローライン止め弁	4PCY-601, 611	○	—		HVAC	V12-3001	原子炉補機（B） 窒素気ループ	①			
	IA, 40余熱除去ポンプ出口流量設定弁	4KCY-601, 612	×	①		HVAC	V12-3002	原子炉補機（B） 窒素気ループ	①			
	IA, 40余熱除去ポンプバイパス流量制御弁	4PCY-604, 614	×	①		HVAC	V12-3003	D/G（B） 窒素気ループ	①			
	IA, 40余熱除去ポンプD/Cループ高流量入口止め弁	4PCY-420, 430	×	②		HVAC	V12-3003B	D/G（B） 窒素気ループ（B）	①			
	IA, 40余熱除去ポンプ入口格納容器隔離弁	4V-309-0925A, B	×	②		HVAC	V12-3004A	D/G（B） 窒素気ループ（A）	①			
	IA, 40余熱除去ポンプ出口格納容器隔離弁	4V-309-043A, B	×	①		HVAC	V12-3004B	D/G（B） 窒素気ループ（B）	①			
	IA, 40余熱除去ポンプ出口遮断弁	4V-309-047A, B	×	②		HVAC	V13-4001A	原子炉補機（HPCS） 窒素気加熱コイル（A）	①			
	IA, 40余熱除去ポンプ高流量注入ライン止め弁	4V-309-040A, B	×	②		HVAC	V13-4001B	原子炉補機（HPCS） 窒素気加熱コイル（B）	①			
	IA, 40余熱除去ポンプ出口流量	4FT-601, 611	○	—		HVAC	V13-4001	原子炉補機（HPCS） 窒素気バッグエアフィルタ	①			
IA, 40余熱除去ポンプ現場操作箱	4IB-14, 15	○	—		HVAC	V13-4002	D/G（HPCS） 窒素気バッグエアフィルタ	①				
格納容器スプレイス系	IA, 40格納容器スプレイポンプ		○	—		HVAC	V13-4P1001	原子炉補機（HPCS） 窒素気バッグエアフィルタ差圧	③			
	IA, 40格納容器スプレイ冷却器		×	②		HVAC	V13-4P1003	D/G（HPCS） 窒素気バッグエアフィルタ差圧指示計	②			
	4より蒸除去薬品タンク		×	②		HVAC	V13-3001	原子炉補機（HPCS） 窒素気ループ	①			
	4より調整剤タンク		×	②		HVAC	V13-3002	原子炉補機（HPCS） 窒素気ループ	①			
	IA, 40より蒸除去薬品注入ライン第1止め弁	4V-CP-064A, B	○	—		HVAC	V13-3003	D/G（HPCS） 窒素気ループ	①			
	IA, 40より蒸除去薬品注入ライン第2止め弁	4V-CP-066A, B	○	—		HVAC	V13-3004	D/G（HPCS） 窒素気ループ	①			
	IA, 40格納容器スプレイポンプ燃料取扱用高流量注入口止め弁	4V-CP-091A, B	○	—		HVAC	V30-4001A	中央制御窒素気冷却コイル（A）	①			
	IA, 40格納容器スプレイポンプ再循環ポンプ種入口閉鎖装置隔離弁	4V-CP-093A, B	○	—		HVAC	V30-4001B	中央制御窒素気冷却コイル（B）	①			
	IA, 40格納容器スプレイポンプ出口格納容器隔離弁	4V-CP-024A, B	○	—		HVAC	V30-4001C	中央制御窒素気冷却コイル（C）	①			
	4格納容器圧力（圧縮機）I, II, III, IV	4PT-950, 951, 952, 953	○	—		HVAC	V30-4001D	中央制御窒素気冷却コイル（D）	①			
主蒸気及び主給水系、補助給水系	IA, 40格納容器スプレイポンプ現場操作箱	4IB-18, 19	○	—		HVAC	V30-4001E	中央制御窒素気冷却コイル（E）	①			
	4タービン動補給給水ポンプ		○	—		HVAC	V30-4001F	中央制御窒素気冷却コイル（F）	①			
	IA, 40電動補助給水ポンプ		○	—								
	4復水ピット		×	②								
	4タービン動補給給水ポンプ起動弁A, B	4V-M8-570A, B	○	—								
IA, IB, IC, 40補助給水隔離弁	4V-PV-574A, B, C, D	×	④									
IA, IB, IC, 40電動補助給水ライン流量調整弁	4V-PV-557A, B, C, D	×	④									

※1 評価対象外とした理由
 ①設計より機能を喪失しない
 ②PCV内耐震増強仕様の設備
 ③動作機能の喪失により安全機能に影響しない
 ④他の設備で代替される

赤字：設備、運用又は体制の相違（設計方針の相違）
 青字：記載箇所又は記載内容の相違（記載方針の相違）
 緑字：記載表現、設備名称の相違（実質的な相違なし）

第9条 溢水による損傷の防止等（別添1添付資料6）

大飯発電所3/4号炉					女川原子力発電所2号炉				泊発電所3号炉		相違理由	
大飯4号炉防護対象設備のスクリーンアウト（4/10）					表2 溢水影響評価から対象外とした設備一覧（14/24）							
系統	設備	番号	溢水影響評価対象	スクリーンアウトの考え方	系統	機器番号	設備	理由 ^{※1}				
主蒸気及び 主給水系、 補助給水系	4復水ピット電動補助給水ポンプ停止弁	4F-FW-588	×	①	IRAC	V30-4002A	中央初級室給気加熱コイル（A）	①			【大飯】 記載表現の相違 女川審査実績の反映 設計方針の相違 プラント設計の違いによる相違 【女川】 記載表現の相違 設計方針の相違 プラント設計の違いによる相違	
	4復水ピットタービン駆動補助給水ポンプ停止弁	4F-FW-591	×	①	IRAC	V30-4002B	中央初級室給気加熱コイル（B）	①				
	IA, 4B, 4C, 4Dタービン補助給水ライン流量調整弁	4ICV-3715, 3725, 3735, 3745	×	①	IRAC	V30-4002C	中央初級室給気加熱コイル（C）	①				
	IA, 4Bタービン駆動補助給水ポンプ駆動蒸気遮断ライン弁	4V-MS-575A, B	×	①	IRAC	V30-4002D	中央初級室給気加熱コイル（D）	①				
	IA, 4B, 4C, 4D主給水隔離弁	4V-FW-529A, B, C, D	×	④	IRAC	V30-4002E	中央初級室給気加熱コイル（E）	①				
	4復水ピット水位, IV	4LT-3760, 3761	○	—	IRAC	V30-4002F	中央初級室給気加熱コイル（F）	①				
	IA, 4B, 4C, 4D蒸気発生器補助給水流量調整弁	4FT-3716, 3729, 3736, 3746	○	—	IRAC	V30-4002G	中央初級室給気加熱コイル（G）	①				
	IA, B, C, D蒸気発生器減圧水水位	4LT-394, 474, 484, 494	×	②	IRAC	V30-4002H	中央初級室給気加熱コイル（H）	①				
	IA, B, C, D蒸気発生器排気水位	4LT-460, 461, 462, 463, 470, 471, 472, 473, 480, 481, 482, 483, 489, 491, 492, 493	×	②	IRAC	V30-4002I	中央初級室給気加熱コイル（I）	①				
	1タービン駆動補助給水ポンプ起動弁A, B	411F-A, B	○	—	IRAC	V30-4001	中央初級室再循環中性化エアフィルタ	①				
	IA, 4B, 4C, 4D主蒸気隔離弁	4V-MS-623A, B, C, D	×	①	IRAC	V30-4002A	中央初級室再循環高性能エアフィルタ（A）	①				
	IA, 4B, 4C, 4D主蒸気隔離弁バイパス弁	4ICV-3816, 3825, 3835, 3845	○	①	IRAC	V30-4002B	中央初級室再循環高性能エアフィルタ（B）	①				
	IA, 4B, 4C, 4D主蒸気遮断弁	4ICV-3816, 3820, 3830, 3840	○	—	IRAC	V30-4003	中央初級室再循環チャコールエアフィルタ	①				
	IA, 4B, 4C, 4D-1主蒸気安全弁	4V-MS-626A, B, C, D	×	①	IRAC	V30-4004A	MCR給気バッグフィルタ（A）	①				
	IA, 4B, 4C, 4D-2主蒸気安全弁	4V-MS-627A, B, C, D	×	①	IRAC	V30-4004B	MCR給気バッグフィルタ（B）	①				
	IA, 4B, 4C, 4D-3主蒸気安全弁	4V-MS-628A, B, C, D	×	①	IRAC	V30-4005A	中央初級室加圧器（A）	③				
	IA, 4B, 4C, 4D-4主蒸気安全弁	4V-MS-629A, B, C, D	×	①	IRAC	V30-4005B	中央初級室加圧器（B）	③				
	IA, 4B, 4C, 4D-5主蒸気安全弁	4V-MS-630A, B, C, D	×	①	IRAC	V30-4005C	中央初級室加圧器（C）	③				
	IA, 4B, 4C, 4D主蒸気隔離弁主翼ドレンライン弁弁	4V-MS-685A, B, C, D	×	①	IRAC	V30-4005D	中央初級室加圧器（D）	③				
	IA, 4B, 4C, 4D主蒸気遮断弁弁弁	4V-MS-623A, B, C, D	×	①	IRAC	V30-4P1001A	中央初級室給気バッグエアフィルタ（A）差圧指示計	③				
	I, II, III, IV, IA, 4B, 4C, 4D主蒸気圧力	4PT-465, 466, 467, 468, 475, 476, 477, 478, 485, 486, 487, 488, 495, 496, 497, 498	○	—	IRAC	V30-4P1001B	中央初級室給気バッグエアフィルタ（B）差圧指示計	③				
	原子炉循環 冷却系	IA, 4B, 4C, 4D原子炉補助冷却水ポンプ		○	—	IRAC	V30-4P1005	中央初級室再循環高性能エアフィルタ差圧指示計	③			
		4原子炉補機冷却水サージタンク		×	②	IRAC	V30-4P1006	中央初級室再循環高性能エアフィルタ（A）差圧指示計	③			
		IA, 4B原子炉補機冷却水弁閉弁		×	②	IRAC	V30-4P1007	中央初級室再循環チャコールエアフィルタ差圧指示計	③			
IA, 4B格納容器スプレッド冷却器冷却水弁閉弁		4V-CC-178A, B	○	—	IRAC	V30-4P1008	中央初級室再循環高性能エアフィルタ（B）差圧指示計	③				
IA-C, 4B-C原子炉補機冷却水供給管配管遮断弁		4V-CC-606A, B	○	—	IRAC	V30-4E7003A	中央初級室過気配度（A）検出器（変換器付）	③				
IA-C, 4B-C原子炉補機冷却水戻り管配管遮断弁		4V-CC-042A, B	○	—	IRAC	V30-4E7003B	中央初級室過気配度（B）検出器（変換器付）	③				
IA, 4B冷却除去冷却器冷却水止弁弁		4V-CC-114A, B	○	—	IRAC	V30-3001	MCR給気ルーバ	①				
1-1次冷却材ポンプ冷却水戻りライン格納器遮断弁		4V-CC-463	○	—								
1-1次冷却材ポンプ冷却水戻りライン格納器遮断弁		4V-CC-427	×	②								
1-1次冷却材ポンプ冷却水戻りライン格納器遮断弁		4V-CC-429	○	—								
					※1 評価対象外とした理由 ①漏失により機能を喪失しない ②PCV内耐腐蝕仕様設備 ③動作機能の喪失により安全機能に影響しない ④他の設備で代替できる							

赤字：設備、運用又は体制の相違（設計方針の相違）
 青字：記載箇所又は記載内容の相違（記載方針の相違）
 緑字：記載表現、設備名称の相違（実質的な相違なし）

第9条 溢水による損傷の防止等（別添1添付資料6）

大阪発電所3/4号炉					女川原子力発電所2号炉					泊発電所3号炉					相違理由
大阪4号炉防護対象設備のスクリーンアウト (5/10)					表2 溢水影響評価から対象外とした設備一覧 (15/24)										
系統	設備	番号	溢水影響評価対象	スクリーンアウトの考え方	系統	機器番号	設備	理由 ^{※1}	系統	機器番号	設備	理由 ^{※1}			
原子炉機械冷却系	4号炉高圧冷却水ポンプ・蒸発器用冷却水ポンプ	4F-CC-342	○	—	HVAC	V30-X002	MCR排気ルーバ	①	【大阪】 記載表現の相違 女川審査実績の反映 設計方針の相違 プラント設計の違いによる相違	【女川】 記載表現の相違 設計方針の相違 プラント設計の違いによる相違					
	4号炉高圧冷却水ポンプ・蒸発器用冷却水ポンプ	4F-CC-366	○	—	HVAC	V31-B001	計測制御電源 (A) 室給気冷却コイル	①							
	4A, 4B, 4C 高圧冷却水ポンプ用冷却水ポンプ	4F-CC-189A, B	○	—	HVAC	V31-B002	計測制御電源 (A) 室給気加熱コイル	①							
	4号炉高圧冷却水ポンプ・蒸発器用冷却水ポンプ	4F-CC-198A, B, C, D	○	—	HVAC	V31-D001	計測制御電源 (A) 室給気バッグフィルタ	①							
	4号炉高圧冷却水ポンプ・蒸発器用冷却水ポンプ	4F-CC-605, 606	○	—	HVAC	V31-4P1001	計測制御電源 (A) 室給気バッグエアフィルタ差圧指示計	③							
	4号炉高圧冷却水ポンプ・蒸発器用冷却水ポンプ	4LT-1200, 1201	○	—	HVAC	V31-X001	計測制御電源 (A) 室給気ルーバ	①							
	4号炉高圧冷却水ポンプ・蒸発器用冷却水ポンプ	4LB-20, 21, 22, 23	○	—	HVAC	V31-X002	計測制御電源 (A) 室給気ルーバ	①							
	4号炉高圧冷却水ポンプ・蒸発器用冷却水ポンプ	4S-SV-01A, B, C, D	× ^{※2}	③	HVAC	V32-B001	計測制御電源 (B) 室給気冷却コイル	①							
	4号炉高圧冷却水ポンプ・蒸発器用冷却水ポンプ	4S-SV-02A, B, C, D	×	③	HVAC	V32-B002	計測制御電源 (B) 室給気加熱コイル	①							
	4号炉高圧冷却水ポンプ・蒸発器用冷却水ポンプ	4S-SV-570A, B	○	—	HVAC	V32-D001	計測制御電源 (B) 室給気バッグフィルタ	①							
燃料ピット冷却浄化系	4号炉燃料ピットポンプ	4L-SS-01A, B, C, D	○	—	HVAC	V32-4P1001	計測制御電源 (B) 室給気バッグエアフィルタ差圧指示計	③							
	4号炉燃料ピットポンプ	4L-SS-02A, B, C, D	○	—	HVAC	V32-X001	計測制御電源 (B) 室給気ルーバ	①							
	4号炉燃料ピットポンプ	4L-SS-03A, B, C, D	○	—	HVAC	V32-X002	計測制御電源 (B) 室給気ルーバ	①							
	4号炉燃料ピットポンプ	4L-SS-04A, B, C, D	○	—	IA/HVFN	F52-F111	I A第二隔離弁	④							
	4号炉燃料ピットポンプ	4L-SS-05A, B, C, D	○	—	IA/HVFN	F54-F015	H P I N 常用第二隔離弁	④							
	4号炉燃料ピットポンプ	4L-SS-06A, B, C, D	○	—	IA/HVFN	F54-F068A	H P I N 非常用第二隔離弁 (A)	④							
	4号炉燃料ピットポンプ	4L-SS-07A, B, C, D	○	—	IA/HVFN	F54-F068B	H P I N 非常用第二隔離弁 (B)	④							
	4号炉燃料ピットポンプ	4L-SS-08A, B, C, D	○	—	LPCS	E21-P001	軽圧炉心スプレイ系ストレーナ	①							
	4号炉燃料ピットポンプ	4L-SS-09A, B, C, D	○	—	LPCS	E21-P006	L P C S 試験用調整弁	③							
	4号炉燃料ピットポンプ	4L-SS-10A, B, C, D	○	—	LPCS	E21-P016	L P C S 注入ライン試験可能逆止弁	③							
1次系燃料採取系	4号炉燃料採取ライン格納容器第1隔離弁	4F-SS-503	×	②	LPCS	E21-P1001	L P C S ポンプ入口圧力	③							
	4号炉燃料採取ライン格納容器第2隔離弁	4F-SS-606	×	②	LPCS	E21-P1004	L P C S ポンプ出口圧力	③							
	4号炉燃料採取ライン格納容器第3隔離弁	4F-SS-622	×	②	LPCS	E21-P1005	L P C S ポンプ出口圧力	③							
	4号炉燃料採取ライン格納容器第4隔離弁	4F-SS-607	×	①	MS	B21	主蒸気速がし安全弁排気管 T-ークエンチャ (A)	①							
	4号炉燃料採取ライン格納容器第5隔離弁	4F-SS-625	×	②	MS	B21	主蒸気速がし安全弁排気管 T-ークエンチャ (B)	①							
	4号炉燃料採取ライン格納容器第6隔離弁	4F-SS-626	×	②	MS	B21	主蒸気速がし安全弁排気管 T-ークエンチャ (C)	①							
	4号炉燃料採取ライン格納容器第7隔離弁	4F-SS-625	×	②	MS	B21	主蒸気速がし安全弁排気管 T-ークエンチャ (D)	①							
	4号炉燃料採取ライン格納容器第8隔離弁	4F-SS-593A, B, C, D	×	②											
	4号炉燃料採取ライン格納容器第9隔離弁	4F-SS-594	×	①											
	4号炉燃料採取ライン格納容器第10隔離弁	4F-SS-574	×	①											
制御用空気系	4号炉制御用空気圧縮機	4A-SS-574	○	—											
	4号炉制御用空気乾燥器	4A-SS-574	× ^{※2}	③											

※1 評価対象外とした理由
 ① 溢水により機能を喪失しない
 ② PCV内耐震増設仕様の設置
 ③ 動作機種の喪失により安全機能に影響しない
 ④ 他設備で代替できる

赤字：設備、運用又は体制の相違（設計方針の相違）
 青字：記載箇所又は記載内容の相違（記載方針の相違）
 緑字：記載表現、設備名称の相違（実質的な相違なし）

第9条 溢水による損傷の防止等（別添1添付資料6）

大阪発電所3/4号炉					女川原子力発電所2号炉				泊発電所3号炉				相違理由
大阪4号炉防護対象設備のスクリーンアウト (6/10)					表2 溢水影響評価から対象外とした設備一覧 (16/24)								
系統	設備	番号	溢水影響評価対象	スクリーンアウトの考え方	系統	機器番号	設備	理由 ^{※1}					
制御用空気系	4A、4B制御用空気だめ	4A1A1A, B	× ^①	⑤	MS	R21	主蒸気速がし安全弁排気管 T-7クエンチャ (E)	①					【大阪】 記載表現の相違 女川審査実績の反映 設計方針の相違 プラント設計の違いによる相違 【女川】 記載表現の相違 設計方針の相違 プラント設計の違いによる相違
	4A、4B制御用空気主蒸気速がし弁等付帯弁止弁弁	4F-1A-505A, B	○	—	MS	R21	主蒸気速がし安全弁排気管 T-7クエンチャ (F)	①					
	4A-C、4B-C制御用空気母管連通弁	4F-1A-501A, B	○	—	MS	R21	主蒸気速がし安全弁排気管 T-7クエンチャ (G)	①					
	4A、4B制御用空気格納容器隔離弁	4F-1A-508A, B	○	—	MS	R21	主蒸気速がし安全弁排気管 T-7クエンチャ (H)	①					
	4A、4B格納容器内副蒸気クラス脱調用空気注管供給止弁弁	4F-1A-510A, B	×	②	MS	R21	主蒸気速がし安全弁排気管 T-7クエンチャ (I)	①					
	4A、4B制御用空気母管圧力	4PT-1800, 1810	○	—	MS	R21	主蒸気速がし安全弁排気管 T-7クエンチャ (J)	①					
	4A、4B制御用空気圧縮機隔離弁	4IAC-A, B	○	—	MS	R21	主蒸気速がし安全弁排気管 T-7クエンチャ (K)	①					
	4格納容器冷却材ドレンタンクガス分岐ライン格納容器側隔離弁	4F-9L-078	×	②	MS	R21	主蒸気速がし安全弁排気管 T-7クエンチャ (L)	①					
	4格納容器冷却材ドレンタンクガス分岐ライン格納容器側隔離弁	4F-9L-079	×	①	MS	R21-000JA	主蒸気速し安全弁 (A) 遮し弁機能用アキュムレータ	①					
	4格納容器冷却材ドレンタンクベントライン格納容器側隔離弁	4F-9L-083	×	②	MS	R21-000JB	主蒸気速し安全弁 (B) 遮し弁機能用アキュムレータ	①					
廃棄物処理系	4格納容器冷却材ドレンタンクベントライン格納容器側隔離弁	4F-9L-084	×	③	MS	R21-000JC	主蒸気速し安全弁 (C) 遮し弁機能用アキュムレータ	①					
	4格納容器冷却材ドレンタンク蒸気供給ライン格納容器側隔離弁	4F-9L-094	×	①	MS	R21-000JD	主蒸気速し安全弁 (D) 遮し弁機能用アキュムレータ	①					
	4格納容器冷却材ドレンポンプ出口格納容器側第一隔離弁	4F-9L-042	×	②	MS	R21-000JE	主蒸気速し安全弁 (E) 遮し弁機能用アキュムレータ	①					
	4格納容器冷却材ドレンポンプ出口格納容器側第二隔離弁	4F-9L-043	×	①	MS	R21-000JF	主蒸気速し安全弁 (F) 遮し弁機能用アキュムレータ	①					
	4格納容器冷却材ドレンポンプ出口格納容器側第一隔離弁	4F-9L-143	×	②	MS	R21-000JG	主蒸気速し安全弁 (G) 遮し弁機能用アキュムレータ	①					
	4格納容器冷却材ドレンポンプ出口格納容器側第二隔離弁	4F-9L-144	×	①	MS	R21-000JH	主蒸気速し安全弁 (H) 遮し弁機能用アキュムレータ	①					
	4格納容器冷却材ドレンポンプ出口格納容器側第一隔離弁	4F-FS-502	×	①	MS	R21-000JI	主蒸気速し安全弁 (I) 遮し弁機能用アキュムレータ	①					
	4格納容器冷却材ドレンポンプ出口格納容器側第二隔離弁	4F-FS-503	×	②	MS	R21-000JJ	主蒸気速し安全弁 (J) 遮し弁機能用アキュムレータ	①					
	4格納容器冷却材ドレンポンプ出口格納容器側第一隔離弁	4F-1G-009	×	①	MS	R21-000JK	主蒸気速し安全弁 (K) 遮し弁機能用アキュムレータ	①					
	4格納容器冷却材ドレンポンプ出口格納容器側第二隔離弁	4F-1G-008	×	①	MS	R21-000JL	主蒸気速し安全弁 (L) 遮し弁機能用アキュムレータ	①					
—	手動弁 一式		×	③	MS	R21-0002A	主蒸気速がし安全弁アキュムレータ (A) ADS	①					
—	遮止弁 一式		×	③	MS	R21-0002C	主蒸気速がし安全弁アキュムレータ (C) ADS	①					
換気空調系	4換気空調機	4VB	○	—	MS	R21-0002E	主蒸気速がし安全弁アキュムレータ (E) ADS	①					
	4A、4B中央制御室空調ファン		○	—	MS	R21-0002H	主蒸気速がし安全弁アキュムレータ (H) ADS	①					
	4A、4B中央制御室備用ファン		○	—	MS	R21-0002J	主蒸気速がし安全弁アキュムレータ (J) ADS	①					
	4A、4B中央制御室非常用乾燥ファン	4VSP22A, B	○	—	MS	R21-0002L	主蒸気速がし安全弁アキュムレータ (L) ADS	①					
	4A、4B中央制御室外気取入止めダンパ	4D-YS-601A, B	×	①	MS	R21-0003A	主蒸気第一隔離弁 (A) 用アキュムレータ	①					
	4A、4B中央制御室非常用乾燥ファン入口ダンパ	4D-YS-602A, B	○	—	MS	R21-0003B	主蒸気第一隔離弁 (B) 用アキュムレータ	①					
	4A、4B中央制御室空調ファン出口ダンパ	4D-YS-603A, B	○	—	MS	R21-0003C	主蒸気第一隔離弁 (C) 用アキュムレータ	①					
	4A、4B中央制御室備用ファン入口ダンパ	4D-YS-604A, B	○	—	MS								
	4A、4B中央制御室外気取入流量調節ダンパ	4BFD-2874, 2875	○	—	MS								
	4A、4B中央制御室乾燥流量調節ダンパ	4BFD-2885, 2886	○	—	MS								
	4A、4B中央制御室大気放出流量調節ダンパ	4BFD-2887, 2888	×	①	MS								
	4A、4B中央制御室事故時外気取入流量調節ダンパ	4BFD-2889, 2890	○	—	MS								
	4A、4B中央制御室事故時乾燥流量調節ダンパ	4BFD-2891, 2892	○	—	MS								

※1 評価対象外とした理由
 ①原状より機能を喪失しない
 ②NIV内耐震域仕様の設備
 ③動作機能の喪失により安全機能に影響しない
 ④他の設備で代替できる

赤字：設備、運用又は体制の相違（設計方針の相違）
 青字：記載箇所又は記載内容の相違（記載方針の相違）
 緑字：記載表現、設備名称の相違（実質的な相違なし）

第9条 溢水による損傷の防止等（別添1添付資料6）

大阪発電所3/4号炉					女川原子力発電所2号炉				泊発電所3号炉		相違理由
大阪4号炉防護対象設備のスクリーンアウト (7/10)					表2 溢水影響評価から対象外とした設備一覧 (17/24)						【大阪】 記載表現の相違 女川審査実績の反映 設計方針の相違 プラント設計の違いによる相違 【女川】 記載表現の相違 設計方針の相違 プラント設計の違いによる相違
系統	設備	番号	溢水影響 評価対象	スクリーンアウト の考え方	系統	機器番号	設備	理由 ^{※1}			
換気空調系	4中央制御室温度(1),(2)	4TS-2908,2909	○	—	MS	B21-A003B	主蒸気第一隔離弁(D)用アキュムレータ	①			
	4A,4B中央制御室非常用蒸気ファン出口流量	4FS-2904,2905	○	—	MS	B21-A004A	主蒸気第二隔離弁(A)用アキュムレータ	①			
	4A,4B中央制御室空調ファン出口流量	4FS-2910,2911	○	—	MS	B21-B004B	主蒸気第二隔離弁(B)用アキュムレータ	①			
	44キャッチタンク第1,2隔離ダンパ	24D-Y8-605,606	×	①	MS	B21-A004C	主蒸気第二隔離弁(C)用アキュムレータ	①			
	4A,4B中央制御室外気取入調節ダンパ流量	4HC-2874,2875	○	—	MS	B21-A004D	主蒸気第二隔離弁(D)用アキュムレータ	①			
	4A,4B中央制御室調節ダンパ流量設定	4HC-2885,2886	○	—	MS	B21-F001A	主蒸気逃がし安全弁(A)	②			
	4A,4B中央制御室外気放出ダンパ流量設定	4HC-2887,2888	×	①	MS	B21-F001B	主蒸気逃がし安全弁(B)	②			
	4A,4B中央制御室事故時外気取入調節ダンパ流量設定	4HC-2889,2890	○	—	MS	B21-F001C	主蒸気逃がし安全弁(C)	②			
	4A,4B中央制御室事故時蒸気ダンパ流量設定	4HC-2891,2892	○	—	MS	B21-F001D	主蒸気逃がし安全弁(D)	②			
	4A,4B安全機械用蒸気空調ファン		○	—	MS	B21-F001E	主蒸気逃がし安全弁(E)	②			
	4A,4B安全機械用蒸気空調ファン		○	—	MS	B21-F001F	主蒸気逃がし安全弁(F)	②			
	4安全系電気配管給気止めダンパA,B	4D-Y8-532,533	○	—	MS	B21-F001G	主蒸気逃がし安全弁(G)	②			
	4安全系電気配管排気止めダンパA,B	4D-Y8-536,537	○	—	MS	B21-F001H	主蒸気逃がし安全弁(H)	②			
	4A,4B安全機械用蒸気室温度	4TS-2917,2919	○	—	MS	B21-F001I	主蒸気逃がし安全弁(I)	②			
	4A,4B制御用空気圧縮機室給気ファン		○	—	MS	B21-F001J	主蒸気逃がし安全弁(J)	②			
	4制御用空気圧縮機室排気ダンパA,B	4D-Y8-431A,B	○	—	MS	B21-F001K	主蒸気逃がし安全弁(K)	②			
	4制御用空気圧縮機室室温度	4TS-2771,2772 42773,2774	○	—	MS	B21-F001L	主蒸気逃がし安全弁(L)	②			
	4A,4B電動補助給水ポンプ室給気ファン		○	—	MS	B21-F002A	主蒸気第一隔離弁(A)	②			
	4電動補助給水ポンプ室排気ダンパA,B	4D-Y8-411A,B	○	—	MS	B21-F002B	主蒸気第一隔離弁(B)	②			
	4A,4B電動補助給水ポンプ室温度(1),(2)	4TS-2741,2742 42743,2744	○	—	MS	B21-F002C	主蒸気第一隔離弁(C)	②			
	4A1,4A2,4B1,4B2ディーゼル発電機室給気ファン		○	—	MS	B21-F002D	主蒸気第一隔離弁(D)	②			
	4ディーゼル発電機室排気ダンパA1,A2,B1,B2	4D-Y8-401A,B 4533A,B	○	—	MS	B21-F003A	主蒸気第二隔離弁(A)	③			
	4A,4Bディーゼル発電機室温度(1),(2),(3),(4)	4TS-2701,2702 42703,2704,2711 42712,2713,2714	○	—	MS	B21-F003B	主蒸気第二隔離弁(B)	③			
	4A,4B安全機械室冷却ファン		○	—	MS	B21-F003C	主蒸気第二隔離弁(C)	③			
	4A,4B安全機械室温度(1),(2)	4TS-2980,2981 42982,2983	○	—	MS	B21-F004	主蒸気ドレンライン第一隔離弁	②			
	4A,4B3号酸ポンプ室空調ファン		○	—	MS	B21-F045	主蒸気第二隔離弁リークオフライン隔離弁	④			
	4A,4B3号酸ポンプ室空調ファン給気加熱コイル		○	—	MS	B21-F061	事故後貯水サンプリング第一隔離弁	②			
	4A,4B3号酸ポンプ室温度調節計	4TS-2901,2911	○	—							
	43号酸タンク室温度(1),(2),(3),(4)	4TS-2902,2903 42912,2913	○	—							
	4A,4Bアンモニア蒸気浄化ファン	4SP9A,B	○	—							
4アンモニア蒸気浄化フィルタユニット蒸気加熱コイル	4US18A,B	×	①								
4A,4Bアンモニア排気ダンパ	4D-Y8-101A,B	○	—								
4A,4Bアンモニア戻りダンパ	4D-Y8-104A,B	○	—								
4A,4Bアンモニア全量排気弁	4V-Y8-102A,B	○	—								

※1 評価対象外とした理由
 ①溢水により機能を喪失しない
 ②PCV(耐事故格仕様の設備)
 ③動作機能の喪失により安全機能に影響しない
 ④他の設備で代替できる

赤字：設備、運用又は体制の相違（設計方針の相違）
 青字：記載箇所又は記載内容の相違（記載方針の相違）
 緑字：記載表現、設備名称の相違（実質的な相違なし）

第9条 溢水による損傷の防止等（別添1添付資料6）

大阪発電所3/4号炉					女川原子力発電所2号炉					泊発電所3号炉					相違理由
大阪4号炉防護対象設備のスクリーンアウト (8/10)					表2 溢水影響評価から対象外とした設備一覧 (18/24)										
系統	設備	番号	溢水影響 評価対象	スクリーンアウト の考え方	系統	機器番号	設備	理由 ^{※1}	系統	機器番号	設備	理由 ^{※1}			
換気装置系	IA. 炉アニュウラス少量排気弁	4F-Y5-103A, B	○	—	MS	B21-F002	事故時炉水サンプリング第二隔離弁	㊸	【大阪】 記載表現の相違 女川審査実績の反映 設計方針の相違 プラント設計の違いによる相違 【女川】 記載表現の相違 設計方針の相違 プラント設計の違いによる相違						
	IA. 炉アニュウラス圧力制御器	4PT-252G, 254Z	×	㊸	PLR	B32-F002A	原子炉再循環ポンプ（A）吐出弁	㊸							
	IA. 48格納容器排気ファン出口ダンパ	4F-Y5-006A, B	×	㊸	PLR	B32-F002B	原子炉再循環ポンプ（B）吐出弁	㊸							
	4格納容器排気止めダンパ	4F-Y5-001	×	㊸	PLR	B32-F013	P.L.R. サンプリングライン第一隔離弁	㊸							
	4補助建屋排気流量調節ダンパ	4BCD-2599	×	㊸	PLR	B32-F014	P.L.R. サンプリングライン第二隔離弁	㊸							
	4補助建屋排気止めダンパ	4F-Y5-351	×	㊸	BCIC	E51-B004	原子炉隔離時冷却システム	㊸							
	34放射線管理室排気流量制御ダンパ	34FCF-2976	×	㊸	BCIC	E51-B005	スパーージャ	㊸							
	31放射線管理室排気止めダンパ	31CF-Y5-403	×	㊸	BCIC	E51-F007	R.C.I.C.タービン入口蒸気ライン第一隔離弁	㊸							
	IA. 炉安全補機室排気ダンパ	4F-Y5-105A, B	○	—	BCIC	E51-F027	R.C.I.C.タービン入口蒸気ライン隔離弁	㊸							
	4安全補機室排気第1,2隔離ダンパ	4F-Y5-301, 302	×	㊸	BCIC	E51-F1001	R.C.I.C.ポンプ入口圧力指示計	㊸							
	4安全補機室排気第1,2隔離ダンパ	4F-Y5-303, 304	×	㊸	BCIC	E51-F1003	R.C.I.C.ポンプ出口圧力指示計	㊸							
	4アニュウラス排気第1,2隔離ダンパ	4F-Y5-052, 053	×	㊸	BCIC	E51-F1007	R.C.I.C.ポンプ駆動用タービン入口蒸気圧力指示計	㊸							
	4アニュウラス排気第1,2隔離ダンパ	4F-Y5-058, 059	×	㊸	BCIC	E51-F1009	R.C.I.C.タービン排気圧力指示計	㊸							
	4格納容器排気第2隔離弁	4F-Y5-054	×	㊸	BCIC	E51-F1001A	R.C.I.C.ポンプ入口圧力伝送器	㊸							
	4格納容器排気第1隔離弁	4F-Y5-055	×	㊸	BCV	P42-A001A	原子炉補機冷却水サージタンク（A）	㊸							
	4格納容器排気第1隔離弁	4F-Y5-056	×	㊸	BCV	P42-A001B	原子炉補機冷却水サージタンク（B）	㊸							
	4格納容器排気第2隔離弁	4F-Y5-057	×	㊸	BCV	P42-B001A	原子炉補機冷却水系統交換器（A）	㊸							
	IA. 48安全補機室冷却ファン現場操作箱	4LB-82, 83	○	—	BCV	P42-B001B	原子炉補機冷却水系統交換器（B）	㊸							
	IA1・IA2・4B1・4B2ディーゼル発電機室排気ファン現場操作箱	4LB-84, 85	○	—	BCV	P42-B001C	原子炉補機冷却水系統交換器（C）	㊸							
	IA. 48格納容器補助給水ポンプ室排気ファン現場操作箱	4LB-88, 87	○	—	BCV	P42-B001D	原子炉補機冷却水系統交換器（D）	㊸							
	IA. 48格納容器用空気圧縮機室排気ファン現場操作箱	4LB-90, 91	○	—	BCV	P42-F000A	R.C.W.冷却水供給温度熱交換器（A） 制御弁弁	㊸							
	IA. 48中央制御室蓄積ファン現場操作箱	4LB-95, 96	○	—	BCV	P42-F000B	R.C.W.冷却水供給温度熱交換器（B） 制御弁弁	㊸							
	IA. 48中央制御室空調ファン現場操作箱	4LB-101, 102	○	—	BCV	P42-F000C	R.C.W.冷却水供給温度熱交換器（C） 制御弁弁	㊸							
	3IA, 3IB, 34C, 34D安全補機室閉鎖室空調ファン現場操作箱	34LB-13, 14, 20, 21	○	—	BCV	P42-F010A	R.C.W.冷却水供給温度ポンプ（A） 制御弁弁	㊸							
	IA. 48日ラ働ポンプ室空調ファン現場操作箱	4LB-77, 78	○	—	BCV	P42-F010B	R.C.W.冷却水供給温度ポンプ（B） 制御弁弁	㊸							
	IA. 48アニュウラス空気浄化ファン現場操作箱	4LB-82, 83	○	—											
	IA. 48中央制御室非常用蓄積ファン現場操作箱	4LB-97, 98	○	—											
	4空調用冷水ポンプタンク			×	㊸										
	IA. 4B, 4C, 4D空調用冷凍機			○	—										
	IA. 4B, 4C, 4D空調用冷水ポンプ			○	—										
	IA. 48中央制御室空調ユニット冷水温度調節弁	4TCV-2878, 2879	○	—											
	3IA, 34B安全補機室閉鎖室空調ユニット冷水温度調節弁	34TCV-2798, 2799	○	—											
	4空調用冷水N-ヘッダ休断、戻りライン止め弁	4F-CH-032, 033	○	—											
4制御室排気熱交換器空調ユニット冷水入口、出口格納容器隔離弁	4F-CH-453, 457	×	㊸												
IA. 4B, 4C, 4D空調用冷水ポンプ現場操作箱	4LB-103, 104, 105, 109	○	—												

※1 評価対象外とした理由
 ①溢水により機能を喪失しない
 ②RCV内耐震増任性の設備
 ③動作機能の喪失により安全機能に影響しない
 ④他の設備で代替できる

赤字：設備、運用又は体制の相違（設計方針の相違）
 青字：記載箇所又は記載内容の相違（記載方針の相違）
 緑字：記載表現、設備名称の相違（実質的な相違なし）

第9条 溢水による損傷の防止等（別添1添付資料6）

大阪発電所3/4号炉					女川原子力発電所2号炉				泊発電所3号炉		相違理由	
大阪4号炉防護対象設備のスクリーンアウト (9/10)					表2 溢水影響評価から対象外とした設備一覧 (19/24)							【大阪】
系統	設備	番号	溢水影響 評価対象	スクリーンアウト の考え方	系統	機器番号	設備	理由 ^{※1}			記載表現の相違	
格納容器減圧系 及び水蒸気減圧 系	4A, 4B格納容器減圧装置排気ライン格納容器 減圧1階装置	4V-3P-001A, B	×	②	R/W	P42-F0890	R C W常用冷却水緊急しり断弁 (D)	⑤			女川審査実績の反映	
	4A, 4B格納容器減圧装置排気ライン格納容器 減圧2階装置	4V-3P-002A, B	×	①	R/W	P42-F112A	R C W供給側第二隔離弁 (A)	④			設計方針の相違	
	4A, 4B格納容器本蒸気パイプ配気ライン格納 容器減圧装置	4V-3C-304A, B	×	①	R/W	P42-F112B	R C W供給側第二隔離弁 (B)	④			プラント設計の違いによる相違	
	4A, 4B格納容器本蒸気パイプ配気ライン格納 容器減圧装置	4V-3C-305A, B	×	①	R/W	P42-F115A	R C W戻り側第一隔離弁 (A)	②				
放射性監視設備 空気サンプリング系	4格納容器サンプル取り出しライン格納容 器減圧1階装置	4V-3R-001	×	②	R/W	P42-F115B	R C W戻り側第一隔離弁 (B)	②				
	4格納容器サンプル取り出しライン格納容 器減圧2階装置	4V-3R-002	×	①	R/W	P42-F115B	R C W戻り側第一隔離弁 (B)	②				
	4格納容器サンプル戻りライン格納容器隔 断弁	4V-3R-013	×	①	R/W	P42-FT006A	R C W A系系統流量発信器	③				
	4主盤 (原子炉盤)	4BCP	○	—	R/W	P42-FT006B	R C W B系系統流量発信器	③				
電気盤	4原子炉補助盤	4BAR	○	—	R/W	P42-FT014A	R C W A系常用系入口流量発信器	③				
	4原子炉安全保護計装盤 I, II, III, IV	4RPP-I, II, III, V	○	—	R/W	P42-FT014B	R C W B系常用系入口流量発信器	⑤				
	4A, 4B, 4C, 4D原子炉安全保護ロジック盤	4RPL-A, B, C, D	○	—	R/W	P42-FT016A	R H R熱交換器 (A) 冷却水入口流量発信器	③				
	4安全保護シーケンス盤A61, A62, B61, B62	4SPS-A1, A2, B1, B2	○	—	R/W	P42-FT016B	R H R熱交換器 (B) 冷却水入口流量発信器	③				
電気盤	4A1, 4A2, 4A3, 4A4, 4B1, 4B2, 4B3, 4B4ブレ イク分電盤	4SP-A1, A2, A3, A4 , B1, B2, B3, B4	○	—	R/W	P42-L1000A	R C Wサージタンク (A) 水位	⑤				
	4原子炉トリップ遮断装置	4RTS	○	—	R/W	P42-L1000B	R C Wサージタンク (B) 水位	⑤				
	4A, 4Bトリップ盤	4RCP-A, BRP , 4BP-A, 4BP	○	—	R/W	P42-L1010A	R C Wサージタンク (A) 水位発信器	⑤				
	4A, 4B直流分電盤	4RDP-A, B	○	—	R/W	P42-L1010B	R C Wサージタンク (B) 水位発信器	⑤				
	4A, 4B直流電池	○	○	—	R/W	P42-P1001A	R C Wポンプ (A) 出口圧力	③				
	4A, 4B充電装置	4RCP-A, B	○	—	R/W	P42-P1001B	R C Wポンプ (B) 出口圧力	③				
	4A1, 4A2, 4B1, 4B2マルチラッドスイッチ コア	4RMC-A1, A2, B1, B2	○	—	R/W	P42-P1001C	R C Wポンプ (C) 出口圧力	③				
	4A1, 4A2, 4B1, 4B2パワーセンタ	4RPC-A1, A2, B1, B2	○	—	R/W	P42-P1001D	R C Wポンプ (D) 出口圧力	③				
	4A1, 4A2, 4B1, 4B2原子炉コントロールセン タ	4RCC-A1, A2, B1, B2	○	—	R/W	P42-P1007A	R C Wポンプ (A) 入口圧力	⑤				
	4A, 4B, 4C, 4D計装用電源盤(1)～(5)	4RSC-A, B, C, D	○	—	R/W	P42-P1007B	R C Wポンプ (B) 入口圧力	⑤				
	4A1, 4A2, 4B1, 4B2, 4C1, 4C2, 4D1, 4D2計装用 分電盤	4RFP-A1, A2, B1, B2, C1, C2, D1, D2	○	—	R/W	P42-P1007C	R C Wポンプ (C) 入口圧力	⑤				
	4A, 4B, 4C, 4D計装用交電電源切替盤	4RSP-A, B, C, D	○	—	R/W	P42-P1007D	R C Wポンプ (D) 入口圧力	③				
	4炉内盤	4RIS	○	—	R/W	P42-TE005A	R C W A系冷却水供給温度検出器	⑤				
	4AC, 4BC計装用後備分電盤	4LRD-A, C, BD	○	—	R/W	P42-TE005B	R C W B系冷却水供給温度検出器	⑤				
	4事故時放射線監視装置	4RIMS-III, IV	○	—	R/W	P42-TE017A	R H R熱交換器 (A) 冷却水出口温度検出器	⑤				
	4出力領域中性子束	4V-41, 42, 43, 44	×	②	R/W	P42-TE017B	R H R熱交換器 (B) 冷却水出口温度検出器	⑤				
	4中性子線領域中性子束	4V-51, 52	×	②								
	4格納容器高圧シールドリアモータ (低レン ジ)・1高レンジ)	4RE-91A, 91B , 92A, 92B	×	②								
						※1 評価対象外とした理由 ①溢水により機能を喪失しない ②炉内制震増設仕様の設備 ③動作機能の喪失により安全機能に影響しない ④他の設備で代替できる						

赤字：設備、運用又は体制の相違（設計方針の相違）
 青字：記載箇所又は記載内容の相違（記載方針の相違）
 緑字：記載表現、設備名称の相違（実質的な相違なし）

第9条 溢水による損傷の防止等（別添1添付資料6）

大阪発電所3/4号炉	女川原子力発電所2号炉	泊発電所3号炉	相違理由																																																																																																																																						
<p>大阪4号炉防護対象設備のスクリーンアウト (10/10)</p> <table border="1" data-bbox="134 215 672 343"> <thead> <tr> <th>系統</th> <th>設備</th> <th>番号</th> <th>溢水影響評価対象</th> <th>スクリーンアウトの考え方</th> </tr> </thead> <tbody> <tr> <td rowspan="4">非常用電源系</td> <td>HA, 4Bディーゼル機関</td> <td></td> <td>○</td> <td>—</td> </tr> <tr> <td>HA, 4Bディーゼル発電機</td> <td></td> <td>○</td> <td>—</td> </tr> <tr> <td>HA, 4Bディーゼル発電機コントロールセンサ</td> <td>400C-A, B</td> <td>○</td> <td>—</td> </tr> <tr> <td>HA, 4Bディーゼル発電機補修装置</td> <td>400C-A, B</td> <td>○</td> <td>—</td> </tr> </tbody> </table> <p>スクリーンアウトの考え方 ①プラント停止操作時に動作要求のない電動弁及び動作機能喪失によりフェイルポジションとなる空気作動弁並びに安全弁は機能喪失しても安全機能に影響ない（動作要求のない原子炉格納容器外設置の格納容器隔離弁を含む）。 ②原子炉格納容器内の防護対象設備は温度、圧力条件及び溢水影響を考慮した耐腐蝕仕様であるため機能喪失しない。又は、溢水事故が発生した場合のプラント停止操作において必ずしも必要でないもの。 ③タンク、熱弁、遮断弁、手動弁等の静的機器は溢水により機能喪失しない。 ④他の設備で代替できる。</p> <p>＜溢水影響評価対象外の注記＞ *1 静置機器は溢水により機能喪失しないが、プラント停止の対応設備を明確にするために防護対象設備リストに追加した。一方、機能喪失高さは「—」として溢水影響評価の対象外とした。</p>	系統	設備	番号	溢水影響評価対象	スクリーンアウトの考え方	非常用電源系	HA, 4Bディーゼル機関		○	—	HA, 4Bディーゼル発電機		○	—	HA, 4Bディーゼル発電機コントロールセンサ	400C-A, B	○	—	HA, 4Bディーゼル発電機補修装置	400C-A, B	○	—	<p>表2 溢水影響評価から対象外とした設備一覧 (20/24)</p> <table border="1" data-bbox="705 215 1265 973"> <thead> <tr> <th>系統</th> <th>機器番号</th> <th>設備</th> <th>理由*1</th> </tr> </thead> <tbody> <tr> <td>BD</td> <td>E11-F003</td> <td>D/W LCVサブ第一隔離弁</td> <td>②</td> </tr> <tr> <td>BD</td> <td>E11-F103</td> <td>D/W HCVサブ第一隔離弁</td> <td>②</td> </tr> <tr> <td>BD</td> <td>E11-8001A</td> <td>残留熱除去系熱交換器（A）</td> <td>①</td> </tr> <tr> <td>BD</td> <td>E11-8001B</td> <td>残留熱除去系熱交換器（B）</td> <td>①</td> </tr> <tr> <td>BD</td> <td>E11-0001A</td> <td>残留熱除去系A系ストレーナ</td> <td>①</td> </tr> <tr> <td>BD</td> <td>E11-0001B</td> <td>残留熱除去系B系ストレーナ</td> <td>①</td> </tr> <tr> <td>BD</td> <td>E11-0001C</td> <td>残留熱除去系C系ストレーナ</td> <td>①</td> </tr> <tr> <td>BD</td> <td>E11-0PT009A</td> <td>L P C I系A/L P C S注入ライン差圧伝送器</td> <td>③</td> </tr> <tr> <td>BD</td> <td>E11-0PT009B</td> <td>L P C I系B・C注入ライン差圧伝送器</td> <td>③</td> </tr> <tr> <td>BD</td> <td>E11-F012A</td> <td>R H R A系試験用調整弁</td> <td>③</td> </tr> <tr> <td>BD</td> <td>E11-F012B</td> <td>R H R B系試験用調整弁</td> <td>③</td> </tr> <tr> <td>BD</td> <td>E11-F012C</td> <td>R H R C系試験用調整弁</td> <td>③</td> </tr> <tr> <td>BD</td> <td>E11-F014A</td> <td>R H R A系停止時冷却吸込弁</td> <td>①</td> </tr> <tr> <td>BD</td> <td>E11-F014B</td> <td>R H R B系停止時冷却吸込弁</td> <td>①</td> </tr> <tr> <td>BD</td> <td>E11-F015A</td> <td>R H R A系停止時冷却吸込第一隔離弁</td> <td>②</td> </tr> <tr> <td>BD</td> <td>E11-F015B</td> <td>R H R B系停止時冷却吸込第一隔離弁</td> <td>②</td> </tr> <tr> <td>BD</td> <td>E11-F021</td> <td>R H R ヘッドスブレイ注入隔離弁</td> <td>③</td> </tr> <tr> <td>BD</td> <td>E11-F044A</td> <td>R H R A系L P C I注入試験可能逆止弁均圧弁</td> <td>②</td> </tr> <tr> <td>BD</td> <td>E11-F044B</td> <td>R H R B系L P C I注入試験可能逆止弁均圧弁</td> <td>②</td> </tr> <tr> <td>BD</td> <td>E11-F044C</td> <td>R H R C系L P C I注入試験可能逆止弁均圧弁</td> <td>②</td> </tr> <tr> <td>BD</td> <td>E11-F045A</td> <td>R H R A系 R W連絡第一弁</td> <td>③</td> </tr> <tr> <td>BD</td> <td>E11-F045B</td> <td>R H R B系 R W連絡第一弁</td> <td>③</td> </tr> <tr> <td>BD</td> <td>E11-F049A</td> <td>R H R A系系統隔離弁</td> <td>③</td> </tr> <tr> <td>BD</td> <td>E11-F049B</td> <td>R H R B系系統隔離弁</td> <td>③</td> </tr> <tr> <td>BD</td> <td>E11-F058A</td> <td>R H R A系停止時冷却試験可能逆止弁均圧弁</td> <td>②</td> </tr> <tr> <td>BD</td> <td>E11-F058B</td> <td>R H R B系停止時冷却試験可能逆止弁均圧弁</td> <td>②</td> </tr> <tr> <td>BD</td> <td>E11-PT04</td> <td>原子炉ヘッドスブレイ流量変換器</td> <td>③</td> </tr> </tbody> </table> <p>*1 評価対象外とした理由 ①溢水により機能を喪失しない ②FCV耐腐蝕仕様の設備 ③動作機能の喪失により安全機能に影響しない ④他の設備で代替できる</p>	系統	機器番号	設備	理由*1	BD	E11-F003	D/W LCVサブ第一隔離弁	②	BD	E11-F103	D/W HCVサブ第一隔離弁	②	BD	E11-8001A	残留熱除去系熱交換器（A）	①	BD	E11-8001B	残留熱除去系熱交換器（B）	①	BD	E11-0001A	残留熱除去系A系ストレーナ	①	BD	E11-0001B	残留熱除去系B系ストレーナ	①	BD	E11-0001C	残留熱除去系C系ストレーナ	①	BD	E11-0PT009A	L P C I系A/L P C S注入ライン差圧伝送器	③	BD	E11-0PT009B	L P C I系B・C注入ライン差圧伝送器	③	BD	E11-F012A	R H R A系試験用調整弁	③	BD	E11-F012B	R H R B系試験用調整弁	③	BD	E11-F012C	R H R C系試験用調整弁	③	BD	E11-F014A	R H R A系停止時冷却吸込弁	①	BD	E11-F014B	R H R B系停止時冷却吸込弁	①	BD	E11-F015A	R H R A系停止時冷却吸込第一隔離弁	②	BD	E11-F015B	R H R B系停止時冷却吸込第一隔離弁	②	BD	E11-F021	R H R ヘッドスブレイ注入隔離弁	③	BD	E11-F044A	R H R A系L P C I注入試験可能逆止弁均圧弁	②	BD	E11-F044B	R H R B系L P C I注入試験可能逆止弁均圧弁	②	BD	E11-F044C	R H R C系L P C I注入試験可能逆止弁均圧弁	②	BD	E11-F045A	R H R A系 R W連絡第一弁	③	BD	E11-F045B	R H R B系 R W連絡第一弁	③	BD	E11-F049A	R H R A系系統隔離弁	③	BD	E11-F049B	R H R B系系統隔離弁	③	BD	E11-F058A	R H R A系停止時冷却試験可能逆止弁均圧弁	②	BD	E11-F058B	R H R B系停止時冷却試験可能逆止弁均圧弁	②	BD	E11-PT04	原子炉ヘッドスブレイ流量変換器	③		<p>【大阪】 記載表現の相違 女川審査実績の反映 設計方針の相違 プラント設計の違いによる相違</p> <p>【女川】 記載表現の相違 設計方針の相違 プラント設計の違いによる相違</p>
系統	設備	番号	溢水影響評価対象	スクリーンアウトの考え方																																																																																																																																					
非常用電源系	HA, 4Bディーゼル機関		○	—																																																																																																																																					
	HA, 4Bディーゼル発電機		○	—																																																																																																																																					
	HA, 4Bディーゼル発電機コントロールセンサ	400C-A, B	○	—																																																																																																																																					
	HA, 4Bディーゼル発電機補修装置	400C-A, B	○	—																																																																																																																																					
系統	機器番号	設備	理由*1																																																																																																																																						
BD	E11-F003	D/W LCVサブ第一隔離弁	②																																																																																																																																						
BD	E11-F103	D/W HCVサブ第一隔離弁	②																																																																																																																																						
BD	E11-8001A	残留熱除去系熱交換器（A）	①																																																																																																																																						
BD	E11-8001B	残留熱除去系熱交換器（B）	①																																																																																																																																						
BD	E11-0001A	残留熱除去系A系ストレーナ	①																																																																																																																																						
BD	E11-0001B	残留熱除去系B系ストレーナ	①																																																																																																																																						
BD	E11-0001C	残留熱除去系C系ストレーナ	①																																																																																																																																						
BD	E11-0PT009A	L P C I系A/L P C S注入ライン差圧伝送器	③																																																																																																																																						
BD	E11-0PT009B	L P C I系B・C注入ライン差圧伝送器	③																																																																																																																																						
BD	E11-F012A	R H R A系試験用調整弁	③																																																																																																																																						
BD	E11-F012B	R H R B系試験用調整弁	③																																																																																																																																						
BD	E11-F012C	R H R C系試験用調整弁	③																																																																																																																																						
BD	E11-F014A	R H R A系停止時冷却吸込弁	①																																																																																																																																						
BD	E11-F014B	R H R B系停止時冷却吸込弁	①																																																																																																																																						
BD	E11-F015A	R H R A系停止時冷却吸込第一隔離弁	②																																																																																																																																						
BD	E11-F015B	R H R B系停止時冷却吸込第一隔離弁	②																																																																																																																																						
BD	E11-F021	R H R ヘッドスブレイ注入隔離弁	③																																																																																																																																						
BD	E11-F044A	R H R A系L P C I注入試験可能逆止弁均圧弁	②																																																																																																																																						
BD	E11-F044B	R H R B系L P C I注入試験可能逆止弁均圧弁	②																																																																																																																																						
BD	E11-F044C	R H R C系L P C I注入試験可能逆止弁均圧弁	②																																																																																																																																						
BD	E11-F045A	R H R A系 R W連絡第一弁	③																																																																																																																																						
BD	E11-F045B	R H R B系 R W連絡第一弁	③																																																																																																																																						
BD	E11-F049A	R H R A系系統隔離弁	③																																																																																																																																						
BD	E11-F049B	R H R B系系統隔離弁	③																																																																																																																																						
BD	E11-F058A	R H R A系停止時冷却試験可能逆止弁均圧弁	②																																																																																																																																						
BD	E11-F058B	R H R B系停止時冷却試験可能逆止弁均圧弁	②																																																																																																																																						
BD	E11-PT04	原子炉ヘッドスブレイ流量変換器	③																																																																																																																																						

赤字：設備、運用又は体制の相違（設計方針の相違）
 青字：記載箇所又は記載内容の相違（記載方針の相違）
 緑字：記載表現、設備名称の相違（実質的な相違なし）

大阪発電所3/4号炉	女川原子力発電所2号炉	泊発電所3号炉	相違理由																																																																																																																
	<p>表2 溢水影響評価から対象外とした設備一覧 (21/24)</p> <table border="1" data-bbox="696 210 1279 981"> <thead> <tr> <th>系統</th> <th>機器番号</th> <th>設備</th> <th>理由^{※1}</th> </tr> </thead> <tbody> <tr><td>RHR</td><td>E11-PI001A</td><td>RHRポンプ(A) 入口圧力</td><td>㊸</td></tr> <tr><td>RHR</td><td>E11-PI001B</td><td>RHRポンプ(B) 入口圧力</td><td>㊸</td></tr> <tr><td>RHR</td><td>E11-PI001C</td><td>RHRポンプ(C) 入口圧力</td><td>㊸</td></tr> <tr><td>RHR</td><td>E11-PI004A</td><td>RHRポンプ(A) 出口圧力</td><td>㊸</td></tr> <tr><td>RHR</td><td>E11-PI004B</td><td>RHRポンプ(B) 出口圧力</td><td>㊸</td></tr> <tr><td>RHR</td><td>E11-PI004C</td><td>RHRポンプ(C) 出口圧力</td><td>㊸</td></tr> <tr><td>RHR</td><td>E11-PT005A</td><td>RHRポンプ(A) 出口圧力伝送器</td><td>㊸</td></tr> <tr><td>RHR</td><td>E11-PT005B</td><td>RHRポンプ(B) 出口圧力伝送器</td><td>㊸</td></tr> <tr><td>RHR</td><td>E11-PT005C</td><td>RHRポンプ(C) 出口圧力伝送器</td><td>㊸</td></tr> <tr><td>RHR</td><td>E11-PT013A</td><td>RHR A系入口圧力伝送器</td><td>㊸</td></tr> <tr><td>RHR</td><td>E11-PT013B</td><td>RHR B系入口圧力伝送器</td><td>㊸</td></tr> <tr><td>RHR</td><td>E11-TE007A</td><td>RHR熱交換器(A) 出口温度検出器</td><td>㊸</td></tr> <tr><td>RHR</td><td>E11-TE007B</td><td>RHR熱交換器(B) 出口温度検出器</td><td>㊸</td></tr> <tr><td>RHR</td><td>E11-TE010A</td><td>RHR熱交換器(A) 入口温度検出器</td><td>㊸</td></tr> <tr><td>RHR</td><td>E11-TE010B</td><td>RHR熱交換器(B) 入口温度検出器</td><td>㊸</td></tr> <tr><td>RSW</td><td>P45-D001A</td><td>原子炉補機冷却係水系ストレータ(A)</td><td>㊸</td></tr> <tr><td>RSW</td><td>P45-D001B</td><td>原子炉補機冷却係水系ストレータ(B)</td><td>㊸</td></tr> <tr><td>RSW</td><td>P45-D001C</td><td>原子炉補機冷却係水系ストレータ(C)</td><td>㊸</td></tr> <tr><td>RSW</td><td>P45-D001D</td><td>原子炉補機冷却係水系ストレータ(D)</td><td>㊸</td></tr> <tr><td>RSW</td><td>P45-4PI003A</td><td>R C W熱交換器(A) 管側差圧指示計</td><td>㊸</td></tr> <tr><td>RSW</td><td>P45-4PI003B</td><td>R C W熱交換器(B) 管側差圧指示計</td><td>㊸</td></tr> <tr><td>RSW</td><td>P45-4PI003C</td><td>R C W熱交換器(C) 管側差圧指示計</td><td>㊸</td></tr> <tr><td>RSW</td><td>P45-4PI003D</td><td>R C W熱交換器(D) 管側差圧指示計</td><td>㊸</td></tr> <tr><td>RSW</td><td>P45-PI001A</td><td>R S Wポンプ(A) 出口圧力指示計</td><td>㊸</td></tr> <tr><td>RSW</td><td>P45-PI001B</td><td>R S Wポンプ(B) 出口圧力指示計</td><td>㊸</td></tr> <tr><td>RSW</td><td>P45-PI001C</td><td>R S Wポンプ(C) 出口圧力指示計</td><td>㊸</td></tr> <tr><td>RSW</td><td>P45-PI001D</td><td>R S Wポンプ(D) 出口圧力指示計</td><td>㊸</td></tr> </tbody> </table> <p data-bbox="696 1045 1279 1109"> ※1 評価対象とした理由 ㊸ 溢水により機能を喪失しない ㊹ PCV内耐環境仕様設備 ㊺ 動作機能の喪失により安全機能に影響しない ㊻ 別の設備で代替される </p>	系統	機器番号	設備	理由 ^{※1}	RHR	E11-PI001A	RHRポンプ(A) 入口圧力	㊸	RHR	E11-PI001B	RHRポンプ(B) 入口圧力	㊸	RHR	E11-PI001C	RHRポンプ(C) 入口圧力	㊸	RHR	E11-PI004A	RHRポンプ(A) 出口圧力	㊸	RHR	E11-PI004B	RHRポンプ(B) 出口圧力	㊸	RHR	E11-PI004C	RHRポンプ(C) 出口圧力	㊸	RHR	E11-PT005A	RHRポンプ(A) 出口圧力伝送器	㊸	RHR	E11-PT005B	RHRポンプ(B) 出口圧力伝送器	㊸	RHR	E11-PT005C	RHRポンプ(C) 出口圧力伝送器	㊸	RHR	E11-PT013A	RHR A系入口圧力伝送器	㊸	RHR	E11-PT013B	RHR B系入口圧力伝送器	㊸	RHR	E11-TE007A	RHR熱交換器(A) 出口温度検出器	㊸	RHR	E11-TE007B	RHR熱交換器(B) 出口温度検出器	㊸	RHR	E11-TE010A	RHR熱交換器(A) 入口温度検出器	㊸	RHR	E11-TE010B	RHR熱交換器(B) 入口温度検出器	㊸	RSW	P45-D001A	原子炉補機冷却係水系ストレータ(A)	㊸	RSW	P45-D001B	原子炉補機冷却係水系ストレータ(B)	㊸	RSW	P45-D001C	原子炉補機冷却係水系ストレータ(C)	㊸	RSW	P45-D001D	原子炉補機冷却係水系ストレータ(D)	㊸	RSW	P45-4PI003A	R C W熱交換器(A) 管側差圧指示計	㊸	RSW	P45-4PI003B	R C W熱交換器(B) 管側差圧指示計	㊸	RSW	P45-4PI003C	R C W熱交換器(C) 管側差圧指示計	㊸	RSW	P45-4PI003D	R C W熱交換器(D) 管側差圧指示計	㊸	RSW	P45-PI001A	R S Wポンプ(A) 出口圧力指示計	㊸	RSW	P45-PI001B	R S Wポンプ(B) 出口圧力指示計	㊸	RSW	P45-PI001C	R S Wポンプ(C) 出口圧力指示計	㊸	RSW	P45-PI001D	R S Wポンプ(D) 出口圧力指示計	㊸		<p>【女川】</p> <p>記載表現の相違 設計方針の相違 プラント設計の違いによる相違</p>
系統	機器番号	設備	理由 ^{※1}																																																																																																																
RHR	E11-PI001A	RHRポンプ(A) 入口圧力	㊸																																																																																																																
RHR	E11-PI001B	RHRポンプ(B) 入口圧力	㊸																																																																																																																
RHR	E11-PI001C	RHRポンプ(C) 入口圧力	㊸																																																																																																																
RHR	E11-PI004A	RHRポンプ(A) 出口圧力	㊸																																																																																																																
RHR	E11-PI004B	RHRポンプ(B) 出口圧力	㊸																																																																																																																
RHR	E11-PI004C	RHRポンプ(C) 出口圧力	㊸																																																																																																																
RHR	E11-PT005A	RHRポンプ(A) 出口圧力伝送器	㊸																																																																																																																
RHR	E11-PT005B	RHRポンプ(B) 出口圧力伝送器	㊸																																																																																																																
RHR	E11-PT005C	RHRポンプ(C) 出口圧力伝送器	㊸																																																																																																																
RHR	E11-PT013A	RHR A系入口圧力伝送器	㊸																																																																																																																
RHR	E11-PT013B	RHR B系入口圧力伝送器	㊸																																																																																																																
RHR	E11-TE007A	RHR熱交換器(A) 出口温度検出器	㊸																																																																																																																
RHR	E11-TE007B	RHR熱交換器(B) 出口温度検出器	㊸																																																																																																																
RHR	E11-TE010A	RHR熱交換器(A) 入口温度検出器	㊸																																																																																																																
RHR	E11-TE010B	RHR熱交換器(B) 入口温度検出器	㊸																																																																																																																
RSW	P45-D001A	原子炉補機冷却係水系ストレータ(A)	㊸																																																																																																																
RSW	P45-D001B	原子炉補機冷却係水系ストレータ(B)	㊸																																																																																																																
RSW	P45-D001C	原子炉補機冷却係水系ストレータ(C)	㊸																																																																																																																
RSW	P45-D001D	原子炉補機冷却係水系ストレータ(D)	㊸																																																																																																																
RSW	P45-4PI003A	R C W熱交換器(A) 管側差圧指示計	㊸																																																																																																																
RSW	P45-4PI003B	R C W熱交換器(B) 管側差圧指示計	㊸																																																																																																																
RSW	P45-4PI003C	R C W熱交換器(C) 管側差圧指示計	㊸																																																																																																																
RSW	P45-4PI003D	R C W熱交換器(D) 管側差圧指示計	㊸																																																																																																																
RSW	P45-PI001A	R S Wポンプ(A) 出口圧力指示計	㊸																																																																																																																
RSW	P45-PI001B	R S Wポンプ(B) 出口圧力指示計	㊸																																																																																																																
RSW	P45-PI001C	R S Wポンプ(C) 出口圧力指示計	㊸																																																																																																																
RSW	P45-PI001D	R S Wポンプ(D) 出口圧力指示計	㊸																																																																																																																

赤字：設備、運用又は体制の相違（設計方針の相違）
 青字：記載箇所又は記載内容の相違（記載方針の相違）
 緑字：記載表現、設備名称の相違（実質的な相違なし）

大阪発電所3/4号炉	女川原子力発電所2号炉	泊発電所3号炉	相違理由																																																																																																																
	<p>表2 溢水影響評価から対象外とした設備一覧 (22/24)</p> <table border="1" data-bbox="696 209 1272 983"> <thead> <tr> <th>系統</th> <th>機器番号</th> <th>設備</th> <th>理由^{※1}</th> </tr> </thead> <tbody> <tr><td>ESW</td><td>P45-PT001A</td><td>R S Wポンプ (A) 出口圧力伝感器</td><td>㊸</td></tr> <tr><td>ESW</td><td>P45-PT001B</td><td>R S Wポンプ (B) 出口圧力伝感器</td><td>㊸</td></tr> <tr><td>ESW</td><td>P45-PT001C</td><td>R S Wポンプ (C) 出口圧力伝感器</td><td>㊸</td></tr> <tr><td>ESW</td><td>P45-PT001D</td><td>R S Wポンプ (D) 出口圧力伝感器</td><td>㊸</td></tr> <tr><td>ESW</td><td>P45-T1001A</td><td>R C W熱交換器 (A) 海水出口温度</td><td>㊸</td></tr> <tr><td>ESW</td><td>P45-T1001B</td><td>R C W熱交換器 (B) 海水出口温度</td><td>㊸</td></tr> <tr><td>ESW</td><td>P45-T1001C</td><td>R C W熱交換器 (C) 海水出口温度</td><td>㊸</td></tr> <tr><td>ESW</td><td>P45-T1001D</td><td>R C W熱交換器 (D) 海水出口温度</td><td>㊸</td></tr> <tr><td>SGTS</td><td>T46-4PT002A</td><td>空気乾燥装置 (A) デミスタ差圧指示計</td><td>㊸</td></tr> <tr><td>SGTS</td><td>T46-4PT002B</td><td>空気乾燥装置 (B) デミスタ差圧指示計</td><td>㊸</td></tr> <tr><td>SGTS</td><td>T46-4PT004</td><td>フィルタ装置中性能エアフィルタ差圧指示計</td><td>㊸</td></tr> <tr><td>SGTS</td><td>T46-4PT005</td><td>フィルタ装置前高性能エアフィルタ差圧指示計</td><td>㊸</td></tr> <tr><td>SGTS</td><td>T46-4PT010</td><td>フィルタ装置チャコールエアフィルタ差圧指示計</td><td>㊸</td></tr> <tr><td>SGTS</td><td>T46-4PT013</td><td>フィルタ装置後高性能エアフィルタ差圧指示計</td><td>㊸</td></tr> <tr><td>SGTS</td><td>T46-F401A</td><td>非常用ガス処理系入口弁 (A)</td><td>㊸</td></tr> <tr><td>SGTS</td><td>T46-F401B</td><td>非常用ガス処理系入口弁 (B)</td><td>㊸</td></tr> <tr><td>SLC</td><td>C41</td><td>ほう酸水注入系ポンプ潤滑油ポンプフィルタ</td><td>㊸</td></tr> <tr><td>SLC</td><td>C41-A001</td><td>ほう酸水注入系貯蔵タンク</td><td>㊸</td></tr> <tr><td>SLC</td><td>C41-A003A</td><td>ほう酸水注入系アキュムレータ (A)</td><td>㊸</td></tr> <tr><td>SLC</td><td>C41-A003B</td><td>ほう酸水注入系アキュムレータ (B)</td><td>㊸</td></tr> <tr><td>SLC</td><td>C41-B001</td><td>ほう酸水注入系貯蔵タンク加熱用ヒータ</td><td>㊸</td></tr> <tr><td>SLC</td><td>C41-B002</td><td>ほう酸水注入系貯蔵タンク保溫用ヒータ</td><td>㊸</td></tr> <tr><td>SLC</td><td>C41-LE001</td><td>ほう酸水注入系貯蔵タンク水位検出器</td><td>㊸</td></tr> <tr><td>SLC</td><td>C41-L1001</td><td>ほう酸水注入系貯蔵タンク水位指示計</td><td>㊸</td></tr> <tr><td>SLC</td><td>C41-L1001</td><td>ほう酸水注入系貯蔵タンク水位伝感器</td><td>㊸</td></tr> <tr><td>SLC</td><td>C41-PI010A</td><td>ほう酸水注入系ポンプ (A) 潤滑油圧力指示計</td><td>㊸</td></tr> <tr><td>SLC</td><td>C41-PI010B</td><td>ほう酸水注入系ポンプ (B) 潤滑油圧力指示計</td><td>㊸</td></tr> </tbody> </table> <p>※1 評価対象外とした理由 ㊸ 溢水により機能を喪失しない ㊹ PCI内耐環境仕様 ㊺ 動作機種の喪失により安全機能に影響しない ㊻ 別の設備で代替できる</p>	系統	機器番号	設備	理由 ^{※1}	ESW	P45-PT001A	R S Wポンプ (A) 出口圧力伝感器	㊸	ESW	P45-PT001B	R S Wポンプ (B) 出口圧力伝感器	㊸	ESW	P45-PT001C	R S Wポンプ (C) 出口圧力伝感器	㊸	ESW	P45-PT001D	R S Wポンプ (D) 出口圧力伝感器	㊸	ESW	P45-T1001A	R C W熱交換器 (A) 海水出口温度	㊸	ESW	P45-T1001B	R C W熱交換器 (B) 海水出口温度	㊸	ESW	P45-T1001C	R C W熱交換器 (C) 海水出口温度	㊸	ESW	P45-T1001D	R C W熱交換器 (D) 海水出口温度	㊸	SGTS	T46-4PT002A	空気乾燥装置 (A) デミスタ差圧指示計	㊸	SGTS	T46-4PT002B	空気乾燥装置 (B) デミスタ差圧指示計	㊸	SGTS	T46-4PT004	フィルタ装置中性能エアフィルタ差圧指示計	㊸	SGTS	T46-4PT005	フィルタ装置前高性能エアフィルタ差圧指示計	㊸	SGTS	T46-4PT010	フィルタ装置チャコールエアフィルタ差圧指示計	㊸	SGTS	T46-4PT013	フィルタ装置後高性能エアフィルタ差圧指示計	㊸	SGTS	T46-F401A	非常用ガス処理系入口弁 (A)	㊸	SGTS	T46-F401B	非常用ガス処理系入口弁 (B)	㊸	SLC	C41	ほう酸水注入系ポンプ潤滑油ポンプフィルタ	㊸	SLC	C41-A001	ほう酸水注入系貯蔵タンク	㊸	SLC	C41-A003A	ほう酸水注入系アキュムレータ (A)	㊸	SLC	C41-A003B	ほう酸水注入系アキュムレータ (B)	㊸	SLC	C41-B001	ほう酸水注入系貯蔵タンク加熱用ヒータ	㊸	SLC	C41-B002	ほう酸水注入系貯蔵タンク保溫用ヒータ	㊸	SLC	C41-LE001	ほう酸水注入系貯蔵タンク水位検出器	㊸	SLC	C41-L1001	ほう酸水注入系貯蔵タンク水位指示計	㊸	SLC	C41-L1001	ほう酸水注入系貯蔵タンク水位伝感器	㊸	SLC	C41-PI010A	ほう酸水注入系ポンプ (A) 潤滑油圧力指示計	㊸	SLC	C41-PI010B	ほう酸水注入系ポンプ (B) 潤滑油圧力指示計	㊸		<p>【女川】</p> <p>記載表現の相違 設計方針の相違 プラント設計の違いによる相違</p>
系統	機器番号	設備	理由 ^{※1}																																																																																																																
ESW	P45-PT001A	R S Wポンプ (A) 出口圧力伝感器	㊸																																																																																																																
ESW	P45-PT001B	R S Wポンプ (B) 出口圧力伝感器	㊸																																																																																																																
ESW	P45-PT001C	R S Wポンプ (C) 出口圧力伝感器	㊸																																																																																																																
ESW	P45-PT001D	R S Wポンプ (D) 出口圧力伝感器	㊸																																																																																																																
ESW	P45-T1001A	R C W熱交換器 (A) 海水出口温度	㊸																																																																																																																
ESW	P45-T1001B	R C W熱交換器 (B) 海水出口温度	㊸																																																																																																																
ESW	P45-T1001C	R C W熱交換器 (C) 海水出口温度	㊸																																																																																																																
ESW	P45-T1001D	R C W熱交換器 (D) 海水出口温度	㊸																																																																																																																
SGTS	T46-4PT002A	空気乾燥装置 (A) デミスタ差圧指示計	㊸																																																																																																																
SGTS	T46-4PT002B	空気乾燥装置 (B) デミスタ差圧指示計	㊸																																																																																																																
SGTS	T46-4PT004	フィルタ装置中性能エアフィルタ差圧指示計	㊸																																																																																																																
SGTS	T46-4PT005	フィルタ装置前高性能エアフィルタ差圧指示計	㊸																																																																																																																
SGTS	T46-4PT010	フィルタ装置チャコールエアフィルタ差圧指示計	㊸																																																																																																																
SGTS	T46-4PT013	フィルタ装置後高性能エアフィルタ差圧指示計	㊸																																																																																																																
SGTS	T46-F401A	非常用ガス処理系入口弁 (A)	㊸																																																																																																																
SGTS	T46-F401B	非常用ガス処理系入口弁 (B)	㊸																																																																																																																
SLC	C41	ほう酸水注入系ポンプ潤滑油ポンプフィルタ	㊸																																																																																																																
SLC	C41-A001	ほう酸水注入系貯蔵タンク	㊸																																																																																																																
SLC	C41-A003A	ほう酸水注入系アキュムレータ (A)	㊸																																																																																																																
SLC	C41-A003B	ほう酸水注入系アキュムレータ (B)	㊸																																																																																																																
SLC	C41-B001	ほう酸水注入系貯蔵タンク加熱用ヒータ	㊸																																																																																																																
SLC	C41-B002	ほう酸水注入系貯蔵タンク保溫用ヒータ	㊸																																																																																																																
SLC	C41-LE001	ほう酸水注入系貯蔵タンク水位検出器	㊸																																																																																																																
SLC	C41-L1001	ほう酸水注入系貯蔵タンク水位指示計	㊸																																																																																																																
SLC	C41-L1001	ほう酸水注入系貯蔵タンク水位伝感器	㊸																																																																																																																
SLC	C41-PI010A	ほう酸水注入系ポンプ (A) 潤滑油圧力指示計	㊸																																																																																																																
SLC	C41-PI010B	ほう酸水注入系ポンプ (B) 潤滑油圧力指示計	㊸																																																																																																																

赤字：設備、運用又は体制の相違（設計方針の相違）
 青字：記載箇所又は記載内容の相違（記載方針の相違）
 緑字：記載表現、設備名称の相違（実質的な相違なし）

大阪発電所3/4号炉	女川原子力発電所2号炉	泊発電所3号炉	相違理由																																																																																																																
	<p>表2 溢水影響評価から対象外とした設備一覧 (23/24)</p> <table border="1" data-bbox="698 212 1270 986"> <thead> <tr> <th>系統</th> <th>機器番号</th> <th>設備</th> <th>理由^{※1}</th> </tr> </thead> <tbody> <tr><td>SLC</td><td>C41-TE002</td><td>ほう酸水注入系貯蔵タンク温度検出器</td><td>③</td></tr> <tr><td>SLC</td><td>C41-TE003</td><td>ほう酸水注入系貯蔵タンク温度検出器</td><td>③</td></tr> <tr><td>SLC</td><td>C41-TE004</td><td>S L C貯蔵タンク保溫用ヒータシース表面温度検出器</td><td>③</td></tr> <tr><td>SLC</td><td>C41-TIS002</td><td>ほう酸水注入系貯蔵タンク温度指示計（接点付）</td><td>③</td></tr> <tr><td>SLC</td><td>C41-TIS003</td><td>ほう酸水注入系貯蔵タンク温度指示計（接点付）</td><td>③</td></tr> <tr><td>SLC</td><td>C41-TIS004</td><td>ほう酸水注入系貯蔵タンク保溫用ヒータシース表面温度</td><td>④</td></tr> <tr><td>SFTW</td><td>T11-TE001A</td><td>サブプレッションプール水温度（1.1°）</td><td>②</td></tr> <tr><td>SFTW</td><td>T11-TE001B</td><td>サブプレッションプール水温度（1.1°）</td><td>②</td></tr> <tr><td>SFTW</td><td>T11-TE002A</td><td>サブプレッションプール水温度（3.4°）</td><td>②</td></tr> <tr><td>SFTW</td><td>T11-TE002B</td><td>サブプレッションプール水温度（3.4°）</td><td>②</td></tr> <tr><td>SFTW</td><td>T11-TE003A</td><td>サブプレッションプール水温度（5.6°）</td><td>②</td></tr> <tr><td>SFTW</td><td>T11-TE003B</td><td>サブプレッションプール水温度（5.6°）</td><td>②</td></tr> <tr><td>SFTW</td><td>T11-TE004A</td><td>サブプレッションプール水温度（7.0°）</td><td>②</td></tr> <tr><td>SFTW</td><td>T11-TE004B</td><td>サブプレッションプール水温度（7.0°）</td><td>②</td></tr> <tr><td>SFTW</td><td>T11-TE005A</td><td>サブプレッションプール水温度（10.1°）</td><td>②</td></tr> <tr><td>SFTW</td><td>T11-TE005B</td><td>サブプレッションプール水温度（10.1°）</td><td>②</td></tr> <tr><td>SFTW</td><td>T11-TE006A</td><td>サブプレッションプール水温度（12.4°）</td><td>②</td></tr> <tr><td>SFTW</td><td>T11-TE006B</td><td>サブプレッションプール水温度（12.4°）</td><td>②</td></tr> <tr><td>SFTW</td><td>T11-TE007A</td><td>サブプレッションプール水温度（14.6°）</td><td>②</td></tr> <tr><td>SFTW</td><td>T11-TE007B</td><td>サブプレッションプール水温度（14.6°）</td><td>②</td></tr> <tr><td>SFTW</td><td>T11-TE008A</td><td>サブプレッションプール水温度（16.9°）</td><td>②</td></tr> <tr><td>SFTW</td><td>T11-TE008B</td><td>サブプレッションプール水温度（16.9°）</td><td>②</td></tr> <tr><td>SFTW</td><td>T11-TE009A</td><td>サブプレッションプール水温度（19.1°）</td><td>②</td></tr> <tr><td>SFTW</td><td>T11-TE009B</td><td>サブプレッションプール水温度（19.1°）</td><td>②</td></tr> <tr><td>SFTW</td><td>T11-TE010A</td><td>サブプレッションプール水温度（21.4°）</td><td>②</td></tr> <tr><td>SFTW</td><td>T11-TE010B</td><td>サブプレッションプール水温度（21.4°）</td><td>②</td></tr> <tr><td>SFTW</td><td>T11-TE011A</td><td>サブプレッションプール水温度（23.6°）</td><td>②</td></tr> </tbody> </table> <p>※1 評価対象外とした理由 ①溢水により機能を喪失しない ②PCV内耐腐蝕仕様の設備 ③動作機能の喪失により安全機能に影響しない ④他の設備で代替できる</p>	系統	機器番号	設備	理由 ^{※1}	SLC	C41-TE002	ほう酸水注入系貯蔵タンク温度検出器	③	SLC	C41-TE003	ほう酸水注入系貯蔵タンク温度検出器	③	SLC	C41-TE004	S L C貯蔵タンク保溫用ヒータシース表面温度検出器	③	SLC	C41-TIS002	ほう酸水注入系貯蔵タンク温度指示計（接点付）	③	SLC	C41-TIS003	ほう酸水注入系貯蔵タンク温度指示計（接点付）	③	SLC	C41-TIS004	ほう酸水注入系貯蔵タンク保溫用ヒータシース表面温度	④	SFTW	T11-TE001A	サブプレッションプール水温度（1.1°）	②	SFTW	T11-TE001B	サブプレッションプール水温度（1.1°）	②	SFTW	T11-TE002A	サブプレッションプール水温度（3.4°）	②	SFTW	T11-TE002B	サブプレッションプール水温度（3.4°）	②	SFTW	T11-TE003A	サブプレッションプール水温度（5.6°）	②	SFTW	T11-TE003B	サブプレッションプール水温度（5.6°）	②	SFTW	T11-TE004A	サブプレッションプール水温度（7.0°）	②	SFTW	T11-TE004B	サブプレッションプール水温度（7.0°）	②	SFTW	T11-TE005A	サブプレッションプール水温度（10.1°）	②	SFTW	T11-TE005B	サブプレッションプール水温度（10.1°）	②	SFTW	T11-TE006A	サブプレッションプール水温度（12.4°）	②	SFTW	T11-TE006B	サブプレッションプール水温度（12.4°）	②	SFTW	T11-TE007A	サブプレッションプール水温度（14.6°）	②	SFTW	T11-TE007B	サブプレッションプール水温度（14.6°）	②	SFTW	T11-TE008A	サブプレッションプール水温度（16.9°）	②	SFTW	T11-TE008B	サブプレッションプール水温度（16.9°）	②	SFTW	T11-TE009A	サブプレッションプール水温度（19.1°）	②	SFTW	T11-TE009B	サブプレッションプール水温度（19.1°）	②	SFTW	T11-TE010A	サブプレッションプール水温度（21.4°）	②	SFTW	T11-TE010B	サブプレッションプール水温度（21.4°）	②	SFTW	T11-TE011A	サブプレッションプール水温度（23.6°）	②		<p>【女川】 記載表現の相違 設計方針の相違 プラント設計の違いによる相違</p>
系統	機器番号	設備	理由 ^{※1}																																																																																																																
SLC	C41-TE002	ほう酸水注入系貯蔵タンク温度検出器	③																																																																																																																
SLC	C41-TE003	ほう酸水注入系貯蔵タンク温度検出器	③																																																																																																																
SLC	C41-TE004	S L C貯蔵タンク保溫用ヒータシース表面温度検出器	③																																																																																																																
SLC	C41-TIS002	ほう酸水注入系貯蔵タンク温度指示計（接点付）	③																																																																																																																
SLC	C41-TIS003	ほう酸水注入系貯蔵タンク温度指示計（接点付）	③																																																																																																																
SLC	C41-TIS004	ほう酸水注入系貯蔵タンク保溫用ヒータシース表面温度	④																																																																																																																
SFTW	T11-TE001A	サブプレッションプール水温度（1.1°）	②																																																																																																																
SFTW	T11-TE001B	サブプレッションプール水温度（1.1°）	②																																																																																																																
SFTW	T11-TE002A	サブプレッションプール水温度（3.4°）	②																																																																																																																
SFTW	T11-TE002B	サブプレッションプール水温度（3.4°）	②																																																																																																																
SFTW	T11-TE003A	サブプレッションプール水温度（5.6°）	②																																																																																																																
SFTW	T11-TE003B	サブプレッションプール水温度（5.6°）	②																																																																																																																
SFTW	T11-TE004A	サブプレッションプール水温度（7.0°）	②																																																																																																																
SFTW	T11-TE004B	サブプレッションプール水温度（7.0°）	②																																																																																																																
SFTW	T11-TE005A	サブプレッションプール水温度（10.1°）	②																																																																																																																
SFTW	T11-TE005B	サブプレッションプール水温度（10.1°）	②																																																																																																																
SFTW	T11-TE006A	サブプレッションプール水温度（12.4°）	②																																																																																																																
SFTW	T11-TE006B	サブプレッションプール水温度（12.4°）	②																																																																																																																
SFTW	T11-TE007A	サブプレッションプール水温度（14.6°）	②																																																																																																																
SFTW	T11-TE007B	サブプレッションプール水温度（14.6°）	②																																																																																																																
SFTW	T11-TE008A	サブプレッションプール水温度（16.9°）	②																																																																																																																
SFTW	T11-TE008B	サブプレッションプール水温度（16.9°）	②																																																																																																																
SFTW	T11-TE009A	サブプレッションプール水温度（19.1°）	②																																																																																																																
SFTW	T11-TE009B	サブプレッションプール水温度（19.1°）	②																																																																																																																
SFTW	T11-TE010A	サブプレッションプール水温度（21.4°）	②																																																																																																																
SFTW	T11-TE010B	サブプレッションプール水温度（21.4°）	②																																																																																																																
SFTW	T11-TE011A	サブプレッションプール水温度（23.6°）	②																																																																																																																

赤字：設備、運用又は体制の相違（設計方針の相違）
 青字：記載箇所又は記載内容の相違（記載方針の相違）
 緑字：記載表現、設備名称の相違（実質的な相違なし）

大阪発電所3/4号炉	女川原子力発電所2号炉	泊発電所3号炉	相違理由																																																																																
	<p>表2 溢水影響評価から対象外とした設備一覧 (24/24)</p> <table border="1" data-bbox="698 213 1270 769"> <thead> <tr> <th>系統</th> <th>機器番号</th> <th>設備</th> <th>理由^{※1}</th> </tr> </thead> <tbody> <tr><td>SPTM</td><td>T11-TE011D</td><td>サブプレッションプール水温度 (236°)</td><td>②</td></tr> <tr><td>SPTM</td><td>T11-TE012A</td><td>サブプレッションプール水温度 (259°)</td><td>②</td></tr> <tr><td>SPTM</td><td>T11-TE012B</td><td>サブプレッションプール水温度 (259°)</td><td>②</td></tr> <tr><td>SPTM</td><td>T11-TE013A</td><td>サブプレッションプール水温度 (281°)</td><td>②</td></tr> <tr><td>SPTM</td><td>T11-TE013B</td><td>サブプレッションプール水温度 (281°)</td><td>②</td></tr> <tr><td>SPTM</td><td>T11-TE014A</td><td>サブプレッションプール水温度 (304°)</td><td>②</td></tr> <tr><td>SPTM</td><td>T11-TE014B</td><td>サブプレッションプール水温度 (304°)</td><td>②</td></tr> <tr><td>SPTM</td><td>T11-TE015A</td><td>サブプレッションプール水温度 (326°)</td><td>②</td></tr> <tr><td>SPTM</td><td>T11-TE015B</td><td>サブプレッションプール水温度 (326°)</td><td>②</td></tr> <tr><td>SPTM</td><td>T11-TE016A</td><td>サブプレッションプール水温度 (349°)</td><td>②</td></tr> <tr><td>SPTM</td><td>T11-TE016B</td><td>サブプレッションプール水温度 (349°)</td><td>②</td></tr> <tr><td>TIP</td><td>CS1-F081A</td><td>TIPバルブアセンブリ (ボール弁A・爆発弁A)</td><td>③</td></tr> <tr><td>TIP</td><td>CS1-F081B</td><td>TIPバルブアセンブリ (ボール弁B・爆発弁B)</td><td>③</td></tr> <tr><td>TIP</td><td>CS1-F081C</td><td>TIPバルブアセンブリ (ボール弁C・爆発弁C)</td><td>③</td></tr> <tr><td>TIP</td><td>CS1-F081D</td><td>TIPバルブアセンブリ (ボール弁D・爆発弁D)</td><td>③</td></tr> <tr><td>TIP</td><td>CS1-F083</td><td>TIPバージョイント弁</td><td>③</td></tr> <tr><td>その他</td><td>-</td><td>手動弁一式</td><td>①</td></tr> <tr><td>その他</td><td>-</td><td>逆止弁一式</td><td>①</td></tr> <tr><td>その他</td><td>-</td><td>配管一式</td><td>①</td></tr> </tbody> </table> <p>※1 評価対象外とした理由 ① 溢水により機能を喪失しない ② 炉内圧力増大に感応しない ③ 動作機能の喪失により安全機能に影響しない ④ 他の設備で代替できる</p>	系統	機器番号	設備	理由 ^{※1}	SPTM	T11-TE011D	サブプレッションプール水温度 (236°)	②	SPTM	T11-TE012A	サブプレッションプール水温度 (259°)	②	SPTM	T11-TE012B	サブプレッションプール水温度 (259°)	②	SPTM	T11-TE013A	サブプレッションプール水温度 (281°)	②	SPTM	T11-TE013B	サブプレッションプール水温度 (281°)	②	SPTM	T11-TE014A	サブプレッションプール水温度 (304°)	②	SPTM	T11-TE014B	サブプレッションプール水温度 (304°)	②	SPTM	T11-TE015A	サブプレッションプール水温度 (326°)	②	SPTM	T11-TE015B	サブプレッションプール水温度 (326°)	②	SPTM	T11-TE016A	サブプレッションプール水温度 (349°)	②	SPTM	T11-TE016B	サブプレッションプール水温度 (349°)	②	TIP	CS1-F081A	TIPバルブアセンブリ (ボール弁A・爆発弁A)	③	TIP	CS1-F081B	TIPバルブアセンブリ (ボール弁B・爆発弁B)	③	TIP	CS1-F081C	TIPバルブアセンブリ (ボール弁C・爆発弁C)	③	TIP	CS1-F081D	TIPバルブアセンブリ (ボール弁D・爆発弁D)	③	TIP	CS1-F083	TIPバージョイント弁	③	その他	-	手動弁一式	①	その他	-	逆止弁一式	①	その他	-	配管一式	①		<p>【女川】 記載表現の相違 設計方針の相違 プラント設計の違いによる相違</p>
系統	機器番号	設備	理由 ^{※1}																																																																																
SPTM	T11-TE011D	サブプレッションプール水温度 (236°)	②																																																																																
SPTM	T11-TE012A	サブプレッションプール水温度 (259°)	②																																																																																
SPTM	T11-TE012B	サブプレッションプール水温度 (259°)	②																																																																																
SPTM	T11-TE013A	サブプレッションプール水温度 (281°)	②																																																																																
SPTM	T11-TE013B	サブプレッションプール水温度 (281°)	②																																																																																
SPTM	T11-TE014A	サブプレッションプール水温度 (304°)	②																																																																																
SPTM	T11-TE014B	サブプレッションプール水温度 (304°)	②																																																																																
SPTM	T11-TE015A	サブプレッションプール水温度 (326°)	②																																																																																
SPTM	T11-TE015B	サブプレッションプール水温度 (326°)	②																																																																																
SPTM	T11-TE016A	サブプレッションプール水温度 (349°)	②																																																																																
SPTM	T11-TE016B	サブプレッションプール水温度 (349°)	②																																																																																
TIP	CS1-F081A	TIPバルブアセンブリ (ボール弁A・爆発弁A)	③																																																																																
TIP	CS1-F081B	TIPバルブアセンブリ (ボール弁B・爆発弁B)	③																																																																																
TIP	CS1-F081C	TIPバルブアセンブリ (ボール弁C・爆発弁C)	③																																																																																
TIP	CS1-F081D	TIPバルブアセンブリ (ボール弁D・爆発弁D)	③																																																																																
TIP	CS1-F083	TIPバージョイント弁	③																																																																																
その他	-	手動弁一式	①																																																																																
その他	-	逆止弁一式	①																																																																																
その他	-	配管一式	①																																																																																

赤字：設備、運用又は体制の相違（設計方針の相違）
 青字：記載箇所又は記載内容の相違（記載方針の相違）
 緑字：記載表現、設備名称の相違（実質的な相違なし）

第9条 溢水による損傷の防止等（別添1 添付資料7）

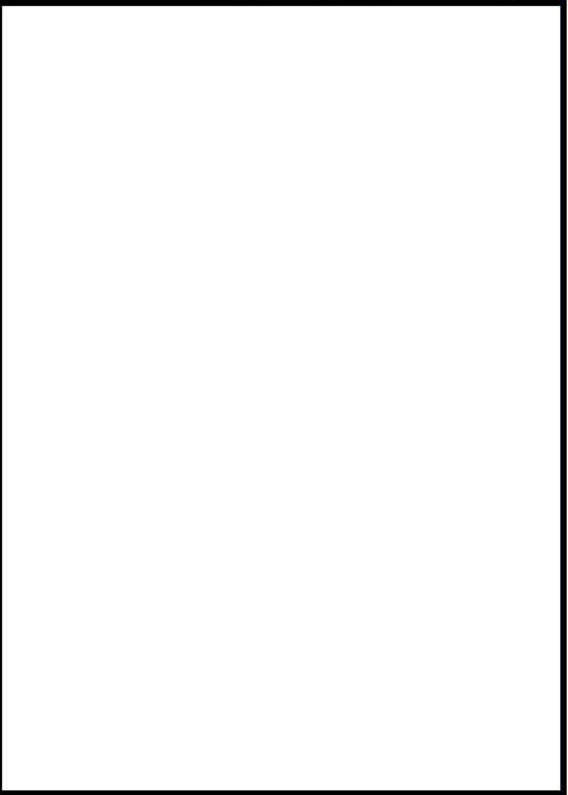
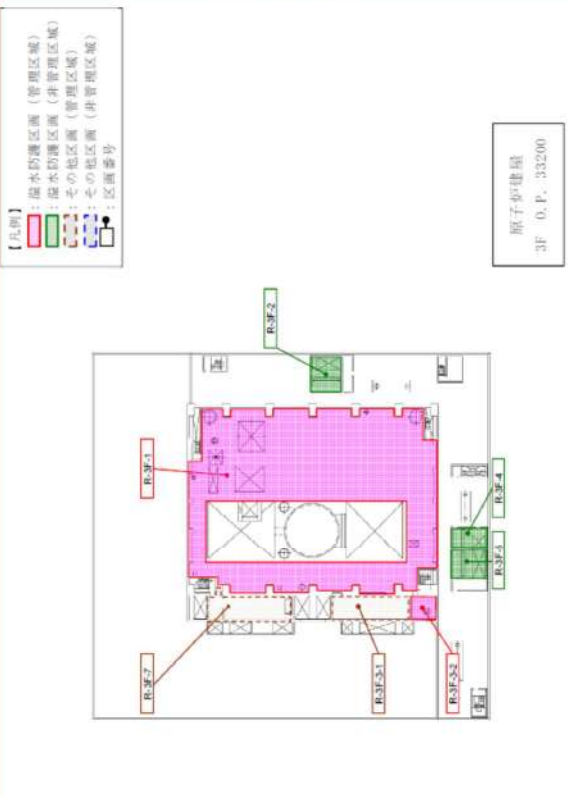
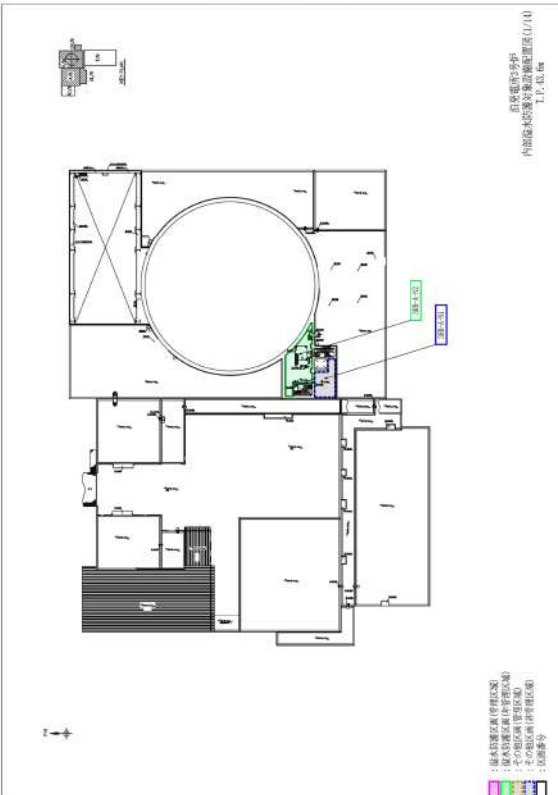

大阪発電所3/4号炉	女川原子力発電所2号炉	泊発電所3号炉	相違理由
添付資料 1.3-1	添付資料 7	添付資料 7	
溢水防護区画の設定	溢水防護区画図	溢水防護区画図	
 <p data-bbox="114 1053 680 1093">特組みの範囲は機密に係る事項ですので公開することはできません。</p>	 <p data-bbox="705 263 817 510">【凡例】 溢水防護区画（管理区域） 溢水防護区画（非管理区域） その他区画（管理区域） その他区画（非管理区域） ；：区画番号</p> <p data-bbox="1198 375 1265 510">原子力発電所 3F 0.P. 33200</p>	 <p data-bbox="1294 263 1850 406">内部給水配管管線設置位置図(1/10) L.P. 43. 4m</p> <p data-bbox="1294 917 1850 1061">溢水防護区画(管理区域) 溢水防護区画(非管理区域) その他区画(管理区域) その他区画(非管理区域) ；：区画番号</p>	<p data-bbox="1868 183 2136 231">【大阪】 記載表現の相違</p> <p data-bbox="1868 247 2136 343">【女川・大阪】 設計方針の相違 プラント構成及び機器配置の相違</p>

赤字：設備、運用又は体制の相違（設計方針の相違）
 青字：記載箇所又は記載内容の相違（記載方針の相違）
 緑字：記載表現、設備名称の相違（実質的な相違なし）

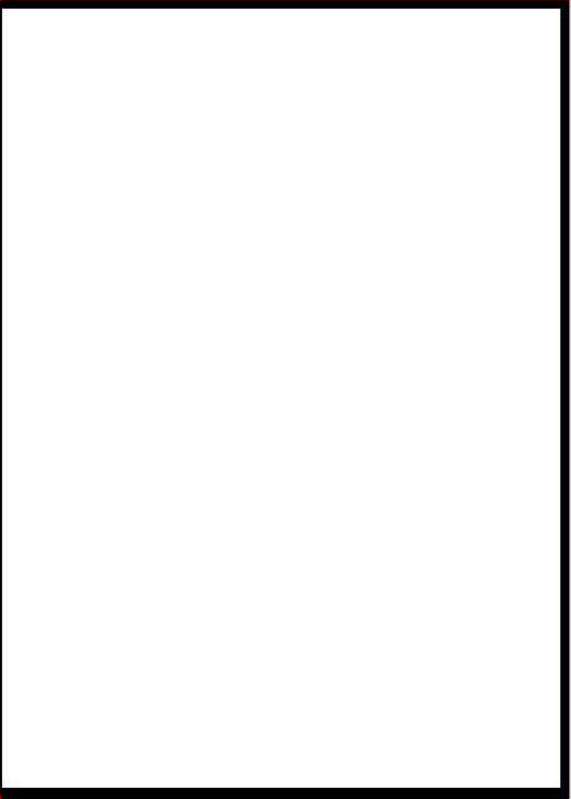
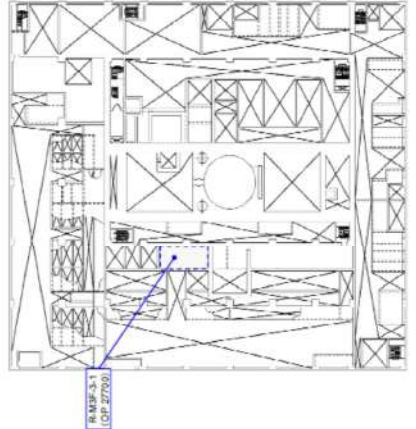
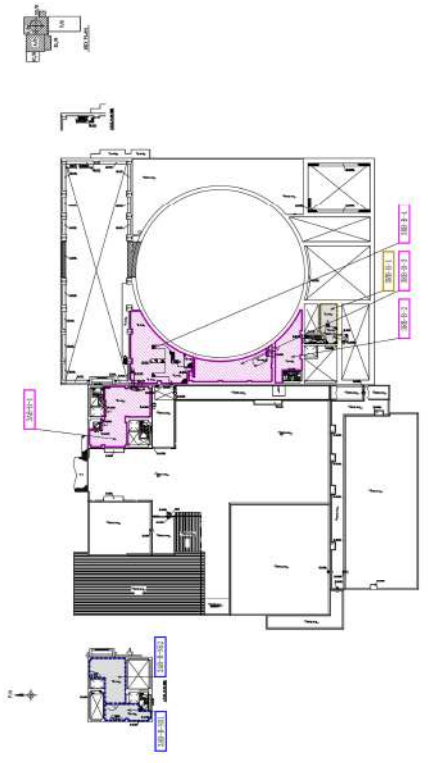
第9条 溢水による損傷の防止等（別添1添付資料7）

大阪発電所3/4号炉	女川原子力発電所2号炉	泊発電所3号炉	相違理由
 <p data-bbox="257 997 672 1021">枠組みの範囲は機密に係る事項ですので公開することはできません。</p>	<p data-bbox="705 199 817 454">【凡例】 ■：基本防護区域（管理区域） ■：基本防護区域（非管理区域） ■：その他区域（管理区域） ■：その他区域（非管理区域） ■：区域番号</p> <p data-bbox="1198 327 1265 470">原子炉建屋 M3F</p>  <p data-bbox="862 933 907 981">RAM3F-S1 OP-27202</p>	 <p data-bbox="1803 183 1848 343">図例番号の付与 内部基本防護対象設備位置図(11) T.P.49.3a</p> <p data-bbox="1780 853 1848 981">■：基本防護区域（管理区域） ■：基本防護区域（非管理区域） ■：その他区域（管理区域） ■：その他区域（非管理区域） ■：区域番号</p>	<p data-bbox="1870 183 1982 207">【女川・大阪】</p> <p data-bbox="1870 215 2004 239">設計方針の相違</p> <p data-bbox="1870 247 2128 271">プラント構成及び機器配置の相違</p>

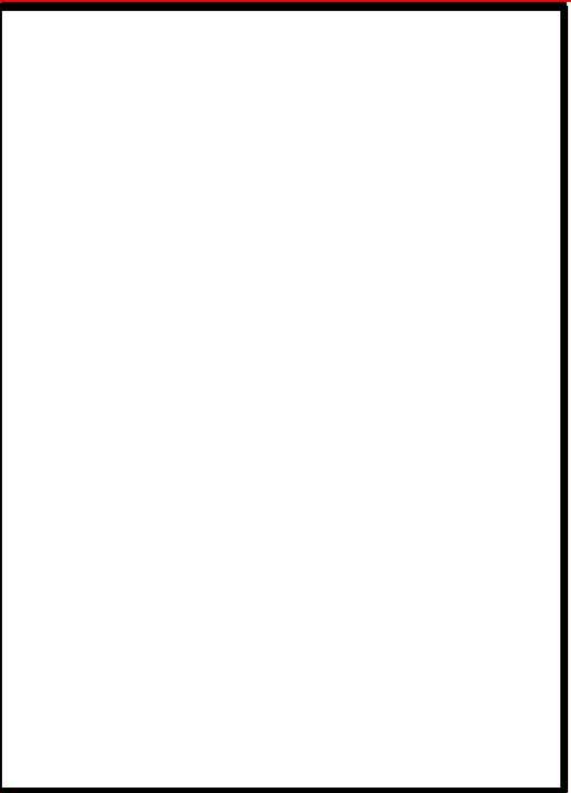
赤字：設備、運用又は体制の相違 (設計方針の相違)
 青字：記載箇所又は記載内容の相違 (記載方針の相違)
 緑字：記載表現、設備名称の相違 (実質的な相違なし)

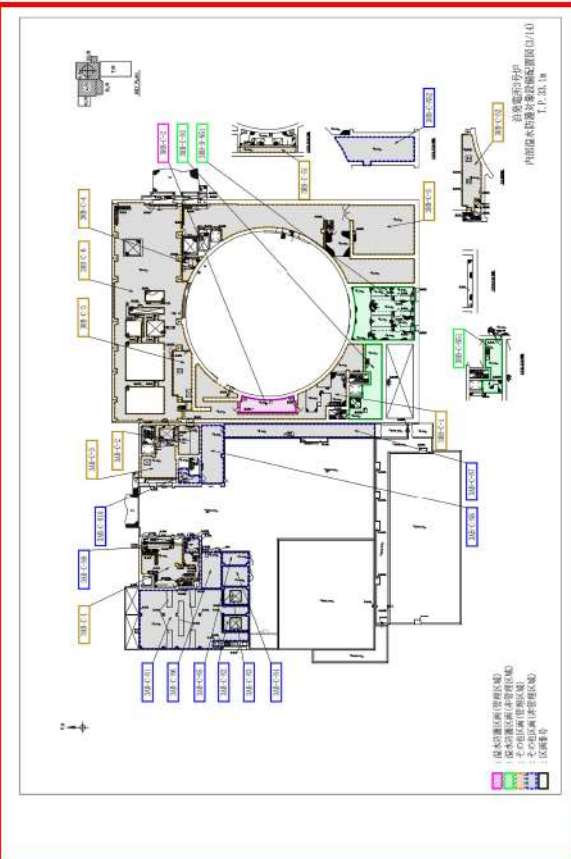
大阪発電所3/4号炉	女川原子力発電所2号炉	泊発電所3号炉	相違理由
 <p data-bbox="257 989 672 1021">作組みの範囲は機密に係る事項ですので公開することはできません。</p>			<p data-bbox="1874 177 1982 199">【女川・大阪】</p> <p data-bbox="1874 215 1993 237">設計方針の相違</p> <p data-bbox="1874 247 2130 269">プラント構成及び機器配置の相違</p>

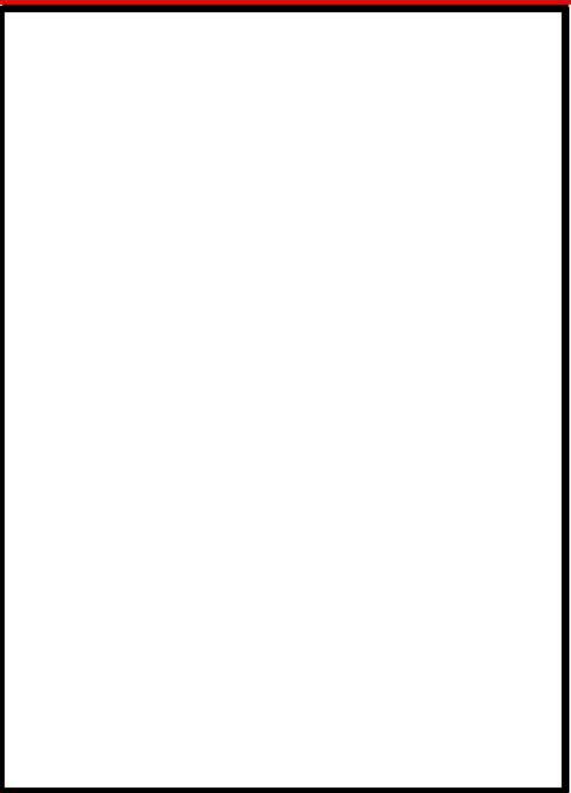
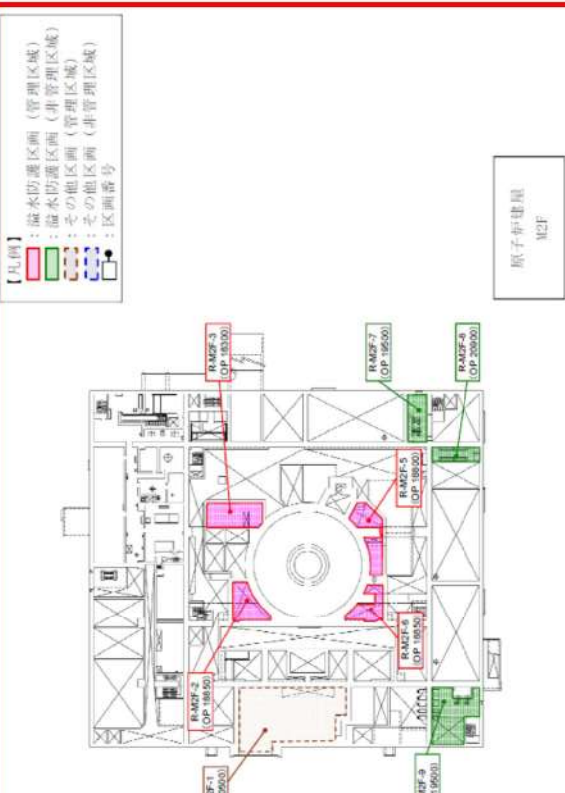
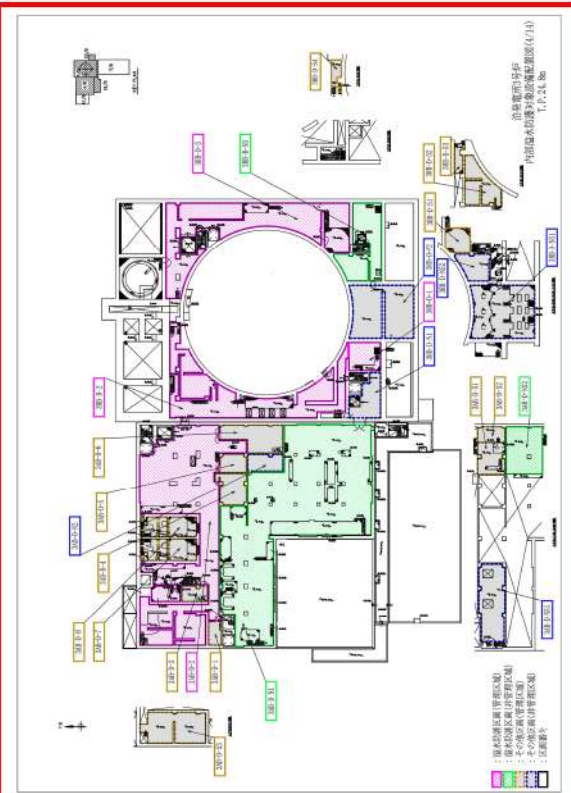

赤字：設備、運用又は体制の相違（設計方針の相違）
 青字：記載箇所又は記載内容の相違（記載方針の相違）
 緑字：記載表現、設備名称の相違（実質的な相違なし）

大阪発電所3/4号炉	女川原子力発電所2号炉	泊発電所3号炉	相違理由
 <p data-bbox="114 981 683 1029">※組みの範囲は機密に係る事項ですので公開することはできません。</p>	 <p data-bbox="703 177 817 478">【凡例】 ■：溢水防護区域（管理区域） ■：溢水防護区域（非管理区域） ■：その他区域（管理区域） ■：その他区域（非管理区域） ■：区域番号</p> <p data-bbox="1187 335 1265 478">原子炉建屋 M2F</p>	 <p data-bbox="1747 177 1848 319">泊発電所3号炉 内部溢水の発生集積区域(注) 17.2A No.</p> <p data-bbox="1747 845 1848 973">■：溢水防護区域(管理区域) ■：溢水防護区域(非管理区域) ■：その他区域(管理区域) ■：その他区域(非管理区域) ■：区域番号</p>	<p data-bbox="1868 177 1982 199">【女川・大阪】</p> <p data-bbox="1868 215 2136 263">設計方針の相違 プラント構成及び機器配置の相違</p>

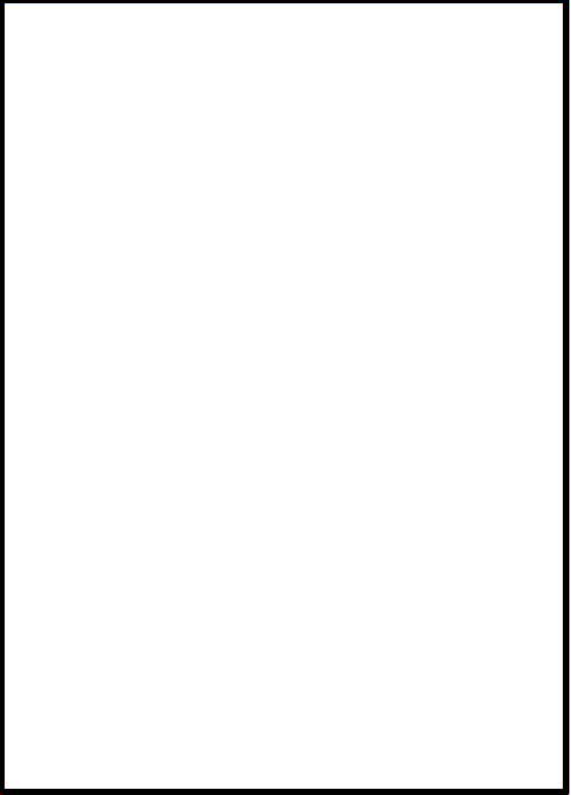
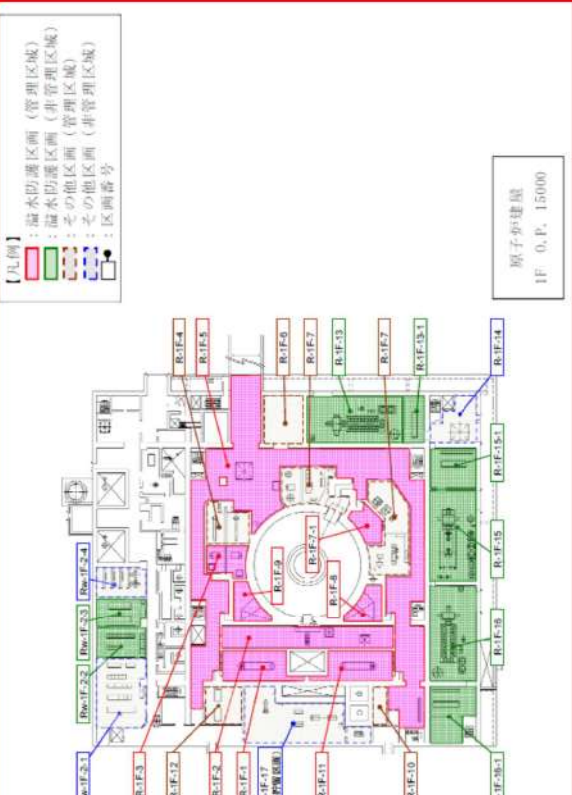
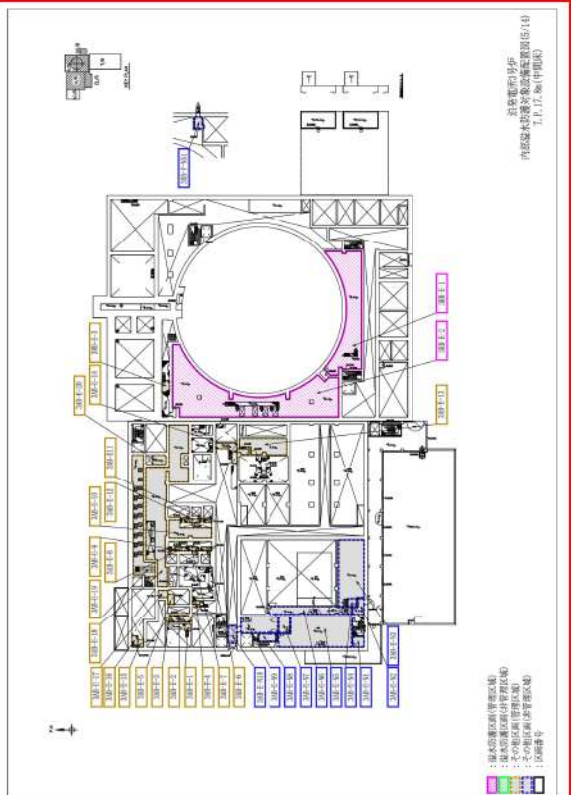
赤字：設備、運用又は体制の相違 (設計方針の相違)
 青字：記載箇所又は記載内容の相違 (記載方針の相違)
 緑字：記載表現、設備名称の相違 (実質的な相違なし)

大阪発電所3/4号炉	女川原子力発電所2号炉	泊発電所3号炉	相違理由
 <p data-bbox="257 991 674 1018">特組みの範囲は機密に係る事項ですので公開することはできません。</p>	 <p data-bbox="703 199 824 470">【凡例】 赤：基本防護区域 (管理区域) 緑：溢水防護区域 (非管理区域) 青：その他区域 (管理区域) 黄：その他区域 (非管理区域) 白：区域番号</p> <p data-bbox="1189 343 1256 470">原子力発電所 1F 0. P. 15000</p>	 <p data-bbox="1771 183 1839 343">泊発電所3号炉 内部基本防護区域(管理区域)510 1F.17.08(中間層)</p> <p data-bbox="1771 847 1839 975">基本防護区域(管理区域) 溢水防護区域(非管理区域) その他区域(管理区域) その他区域(非管理区域) 区域番号</p>	<p data-bbox="1874 177 1989 199">【女川・大阪】</p> <p data-bbox="1874 215 1995 237">設計方針の相違</p> <p data-bbox="1874 247 2130 269">プラント構成及び機器配置の相違</p>

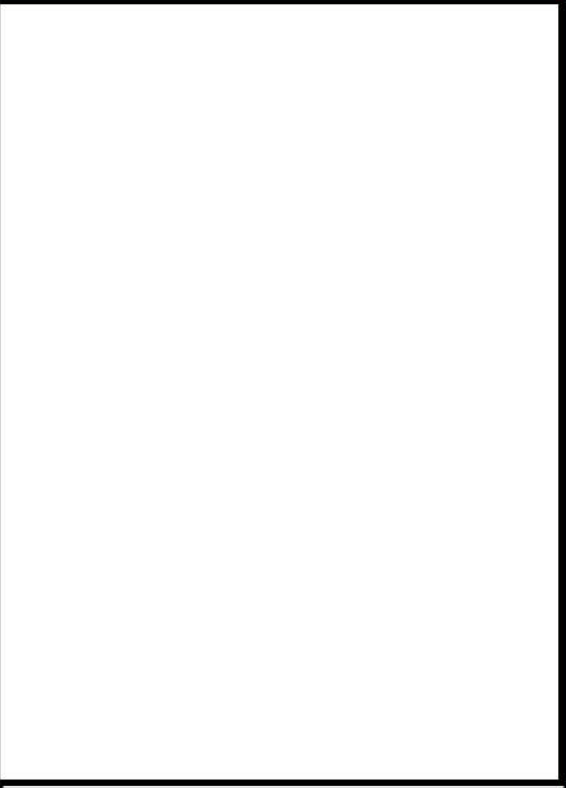
赤字：設備、運用又は体制の相違（設計方針の相違）
 青字：記載箇所又は記載内容の相違（記載方針の相違）
 緑字：記載表現、設備名称の相違（実質的な相違なし）

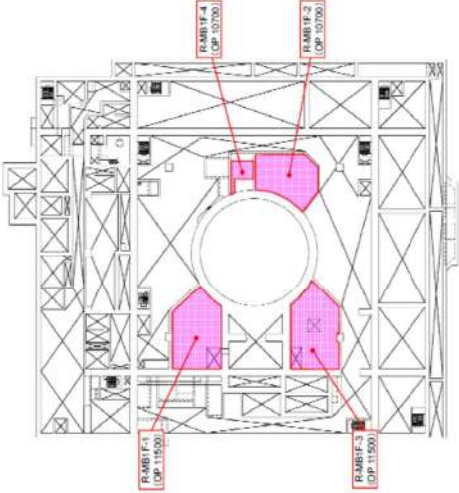
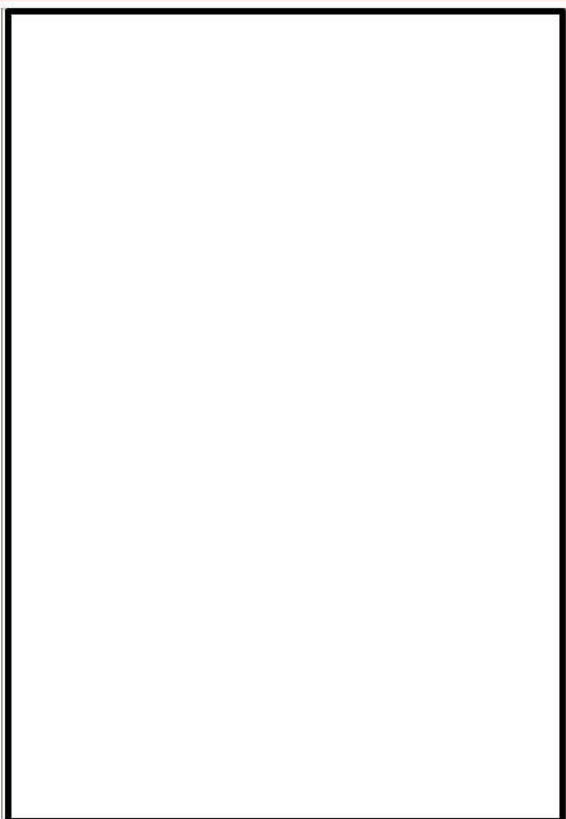
大阪発電所3/4号炉	女川原子力発電所2号炉	泊発電所3号炉	相違理由
 <p data-bbox="116 989 680 1021">  枠組みの範囲は機密に係る事項ですので公開することはできません。 </p>	<div data-bbox="707 197 824 478" style="border: 1px solid black; padding: 5px;"> <p>【凡例】</p> <ul style="list-style-type: none"> ：溢水防護区域（管理区域） ：溢水防護区域（非管理区域） ：その他区域（管理区域） ：その他区域（非管理区域） ：区画番号 </div> <div data-bbox="757 507 1214 1002" style="text-align: center;">  </div>	 <p data-bbox="1290 1040 1854 1072"> 枠組みの内容は機密情報に属しますので公開できません。 </p>	<p>【女川・大阪】</p> <p>設計方針の相違</p> <p>プラント構成及び機器配置の相違</p>

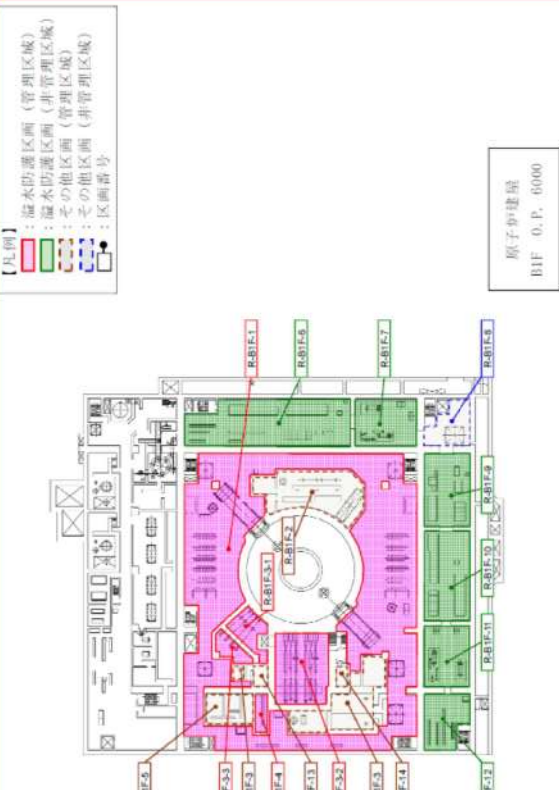
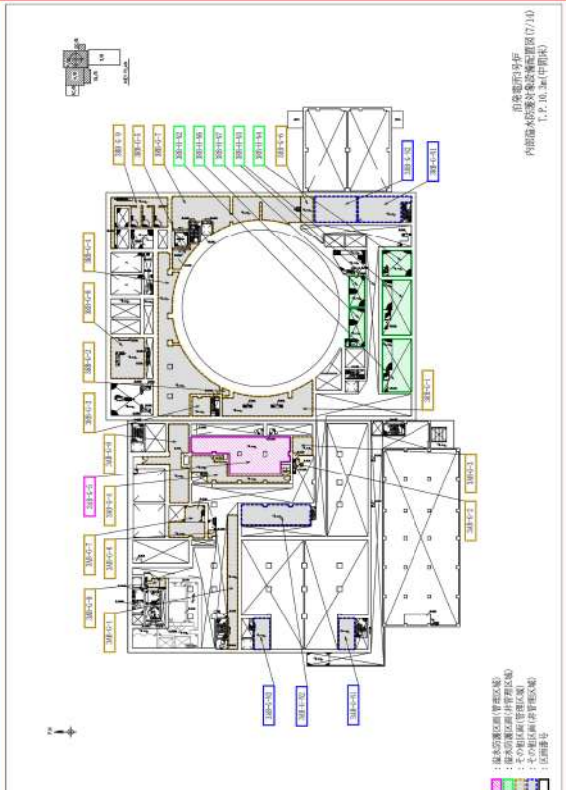

赤字：設備、運用又は体制の相違（設計方針の相違）
 青字：記載箇所又は記載内容の相違（記載方針の相違）
 緑字：記載表現、設備名称の相違（実質的な相違なし）

大阪発電所3/4号炉	女川原子力発電所2号炉	泊発電所3号炉	相違理由
 <p data-bbox="264 991 674 1011">枠組みの範囲は機密に係る事項ですので公開することはできません。</p>	 <p data-bbox="707 411 734 459">【凡例】</p> <ul style="list-style-type: none"> ■：溢水防護区域（管理区域） ■：溢水防護区域（非管理区域） ■：その他区域（管理区域） ■：その他区域（非管理区域） ○：区域番号 <p data-bbox="1205 341 1263 469">原子炉建屋 B1F 0.P. 6000</p>	 <p data-bbox="1778 858 1836 979">■：溢水防護区域（管理区域） ■：溢水防護区域（非管理区域） ■：その他区域（管理区域） ■：その他区域（非管理区域） ○：区域番号</p> <p data-bbox="1800 188 1836 341">泊発電所3号炉 外部設備の対称配置位置図(7/10) 1.P.10.3a(中間版)</p>	<p data-bbox="1872 180 1989 201">【女川・大阪】</p> <p data-bbox="1872 217 1995 237">設計方針の相違</p> <p data-bbox="1872 248 2134 269">プラント構成及び機器配置の相違</p>

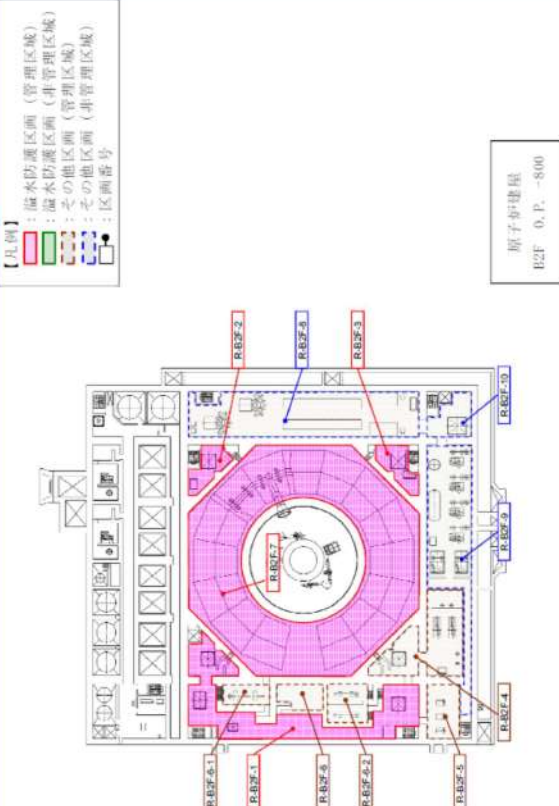
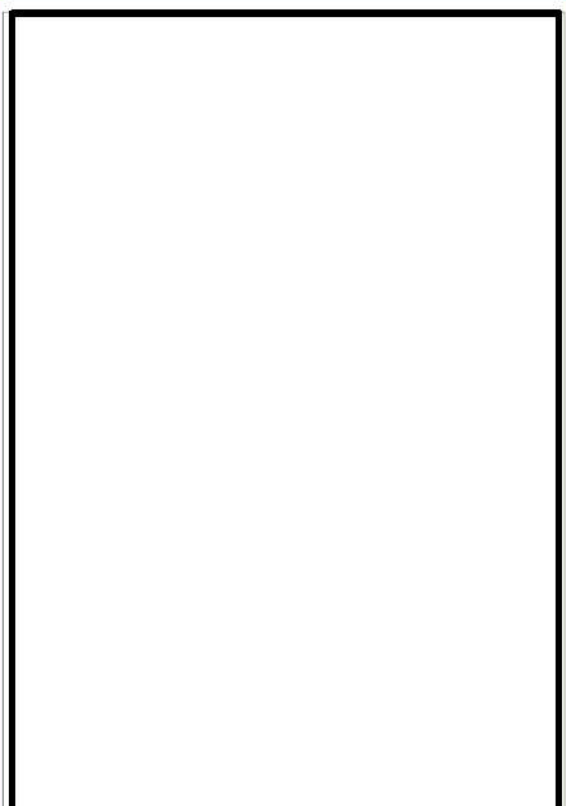
赤字：設備、運用又は体制の相違（設計方針の相違）
 青字：記載箇所又は記載内容の相違（記載方針の相違）
 緑字：記載表現、設備名称の相違（実質的な相違なし）

大阪発電所3/4号炉	女川原子力発電所2号炉	泊発電所3号炉	相違理由
 <p data-bbox="116 1008 680 1034">枠囲みの範囲は機密に係る事項ですので公開することはできません。</p>	 <p data-bbox="707 1008 1263 1034">枠囲みの内容は機密情報に属しますので公開できません。</p>	 <p data-bbox="1290 1008 1854 1034">枠囲みの内容は機密情報に属しますので公開できません。</p>	<p data-bbox="1872 185 2134 210">【女川・大阪】</p> <p data-bbox="1872 217 2134 242">設計方針の相違</p> <p data-bbox="1872 248 2134 274">プラント構成及び機器配置の相違</p>

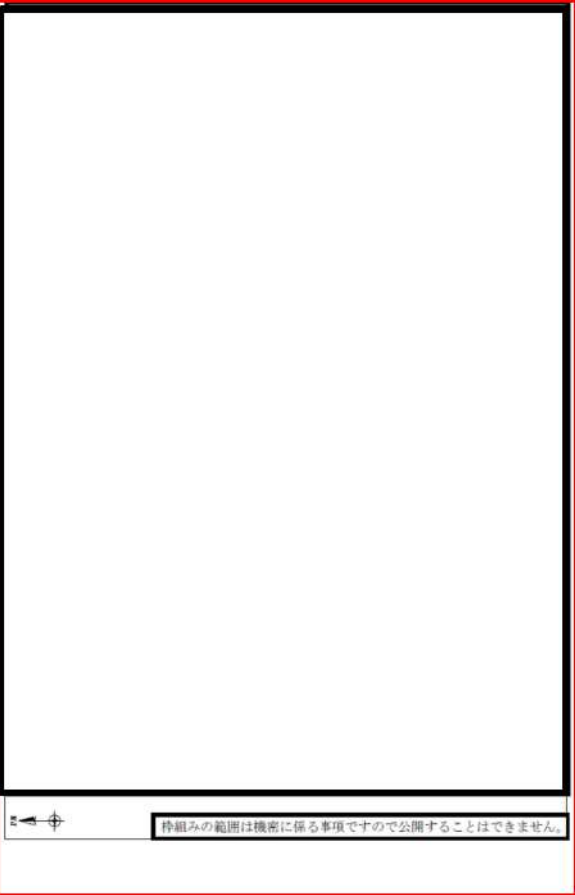
赤字：設備、運用又は体制の相違 (設計方針の相違)
 青字：記載箇所又は記載内容の相違 (記載方針の相違)
 緑字：記載表現、設備名称の相違 (実質的な相違なし)

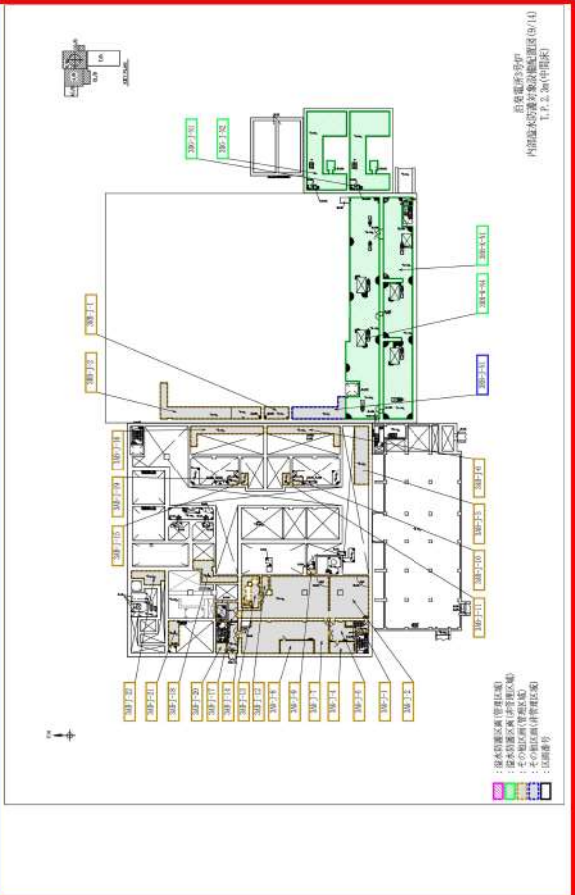
大阪発電所3/4号炉	女川原子力発電所2号炉	泊発電所3号炉	相違理由
 <p data-bbox="264 994 678 1018">枠組みの範囲は機密に係る事項ですので公開することはできません。</p>	 <p data-bbox="701 411 824 467">【凡例】 ■：溢水防護区域 (管理区域) ■：溢水防護区域 (非管理区域) ■：その他区域 (管理区域) ■：その他区域 (非管理区域) ■：区域番号</p> <p data-bbox="1193 336 1256 467">原子炉建屋 E3F 0. P. -8100</p>	 <p data-bbox="1776 188 1839 336">島根電力株式会社 泊発電所3号炉 外部保安設備対象施設配置図(6/11) T.P. 2.2m(中間室)</p> <p data-bbox="1776 850 1839 975">■：溢水防護区域 (管理区域) ■：溢水防護区域 (非管理区域) ■：その他区域 (管理区域) ■：その他区域 (非管理区域) ■：区域番号</p>	<p data-bbox="1874 180 1989 204">【女川・大阪】</p> <p data-bbox="1874 217 1995 240">設計方針の相違</p> <p data-bbox="1874 248 2136 272">プラント構成及び機器配置の相違</p>

赤字：設備、運用又は体制の相違（設計方針の相違）
 青字：記載箇所又は記載内容の相違（記載方針の相違）
 緑字：記載表現、設備名称の相違（実質的な相違なし）

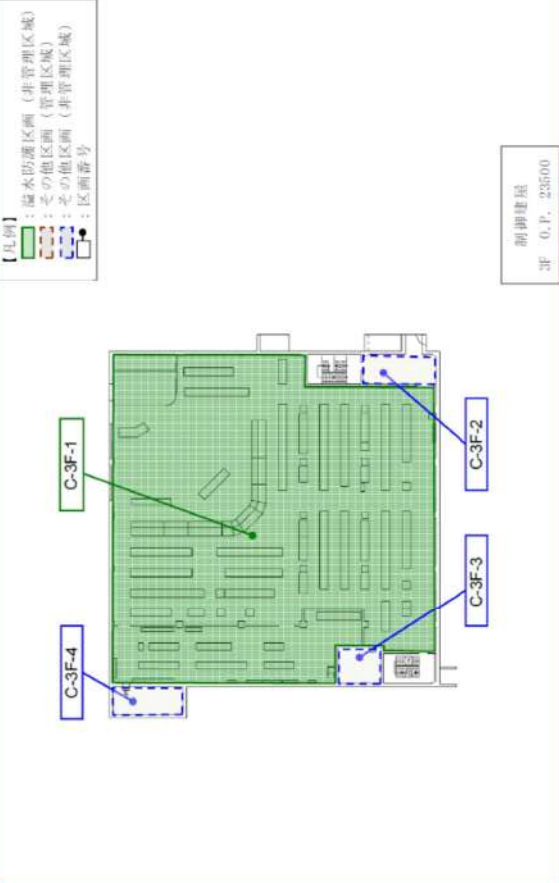
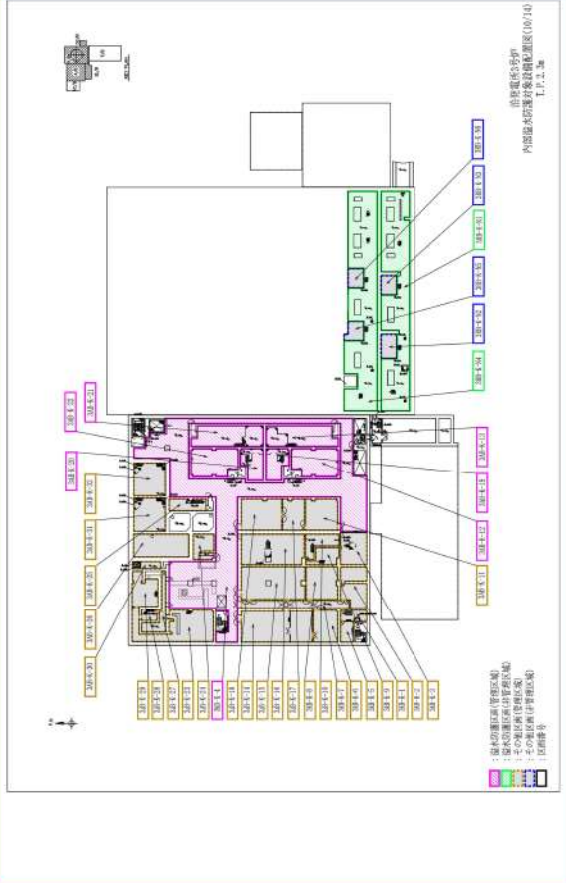
大阪発電所3/4号炉	女川原子力発電所2号炉	泊発電所3号炉	相違理由
 <p data-bbox="264 1011 680 1037">枠組みの範囲は機密に係る事項ですので公開することはできません。</p>			<p data-bbox="1872 178 1989 201">【女川・大阪】</p> <p data-bbox="1872 213 1998 236">設計方針の相違</p> <p data-bbox="1872 248 2132 271">プラント構成及び機器配置の相違</p>

赤字：設備、運用又は体制の相違（設計方針の相違）
 青字：記載箇所又は記載内容の相違（記載方針の相違）
 緑字：記載表現、設備名称の相違（実質的な相違なし）

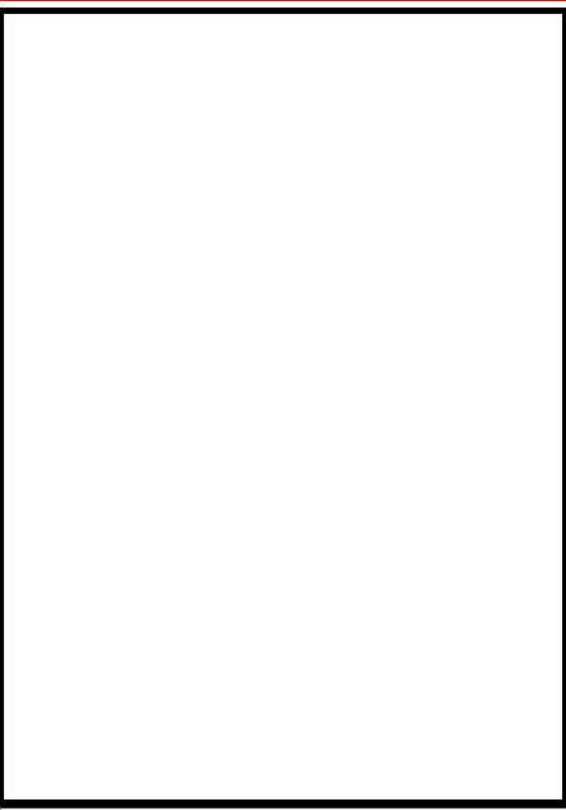
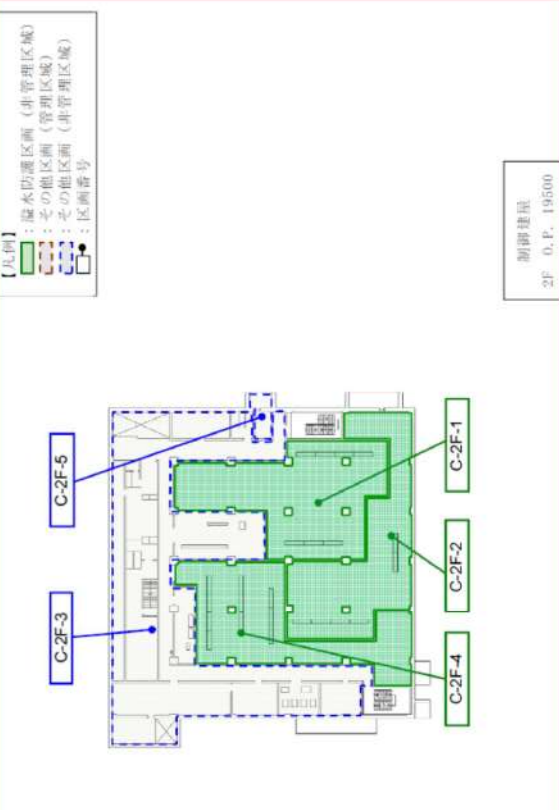
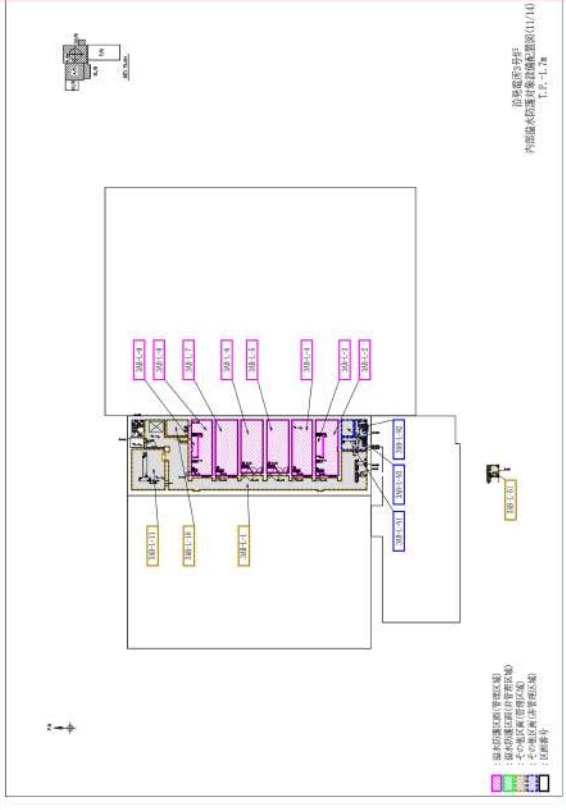
大阪発電所3/4号炉	女川原子力発電所2号炉	泊発電所3号炉	相違理由
 <p data-bbox="264 1013 680 1037">枠組みの範囲は機密に係る事項ですので公開することはできません。</p>	 <p data-bbox="707 199 801 478">【凡例】 ■：溢水防護区域（非管理区域） ■：その他区域（管理区域） ■：その他区域（非管理区域） ○：区域番号</p> <p data-bbox="1209 343 1263 486">制御建屋 2F 0, P, 19500</p>	 <p data-bbox="1769 183 1854 343">泊発電所3号炉 外部溢水防護対象機器配置図(1/10) T.F. 1.7</p> <p data-bbox="1769 853 1854 981">溢水防護区域(管理区域) 溢水防護区域(非管理区域) その他区域(管理区域) その他区域(非管理区域) 区域番号</p>	<p data-bbox="1872 183 1989 199">【女川・大阪】</p> <p data-bbox="1872 215 1993 231">設計方針の相違</p> <p data-bbox="1872 247 2134 263">プラント構成及び機器配置の相違</p>

赤字：設備、運用又は体制の相違（設計方針の相違）
 青字：記載箇所又は記載内容の相違（記載方針の相違）
 緑字：記載表現、設備名称の相違（実質的な相違なし）

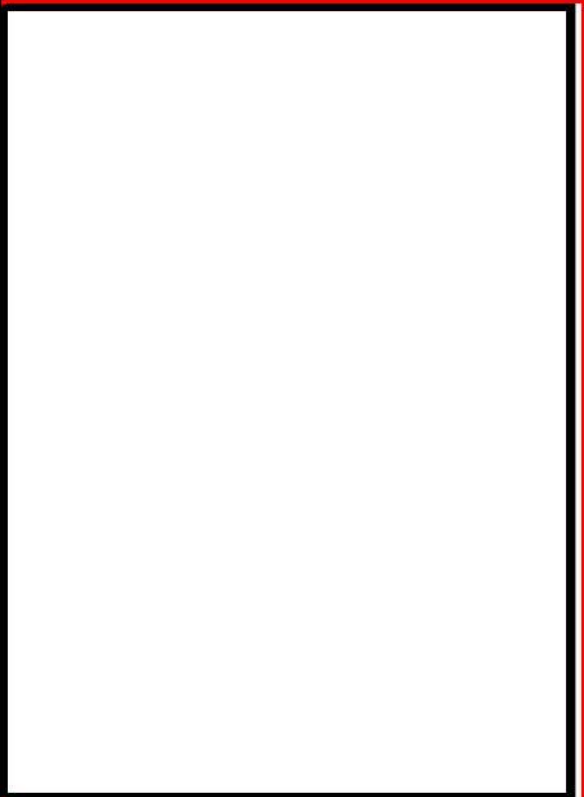
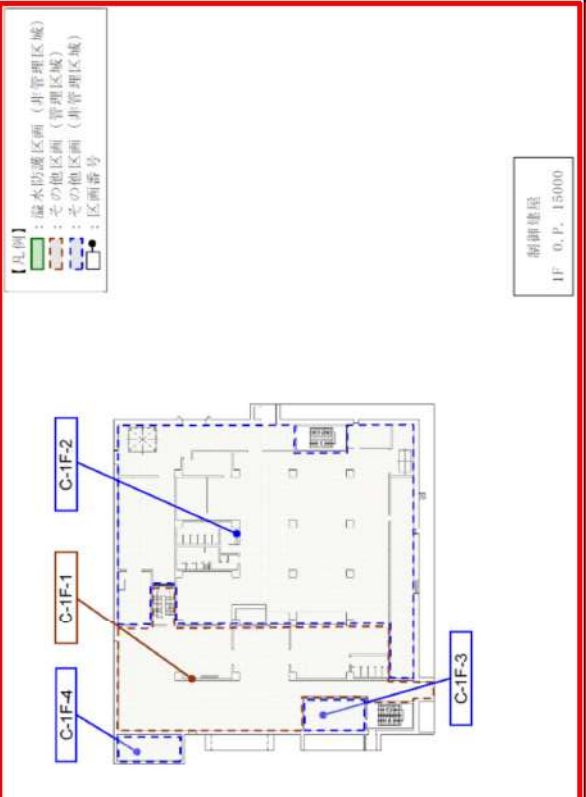
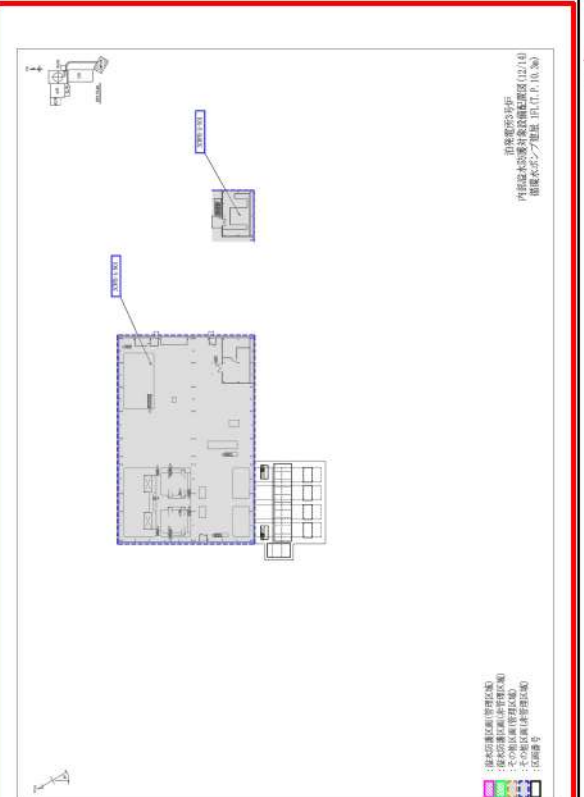
大阪発電所3/4号炉	女川原子力発電所2号炉	泊発電所3号炉	相違理由
 <p data-bbox="257 997 672 1021">枠組みの範囲は機密に係る事項ですので公開することはできません。</p>	 <p data-bbox="705 183 795 454">【凡例】 ■：基本防護区域（非管理区域） ■：その他区域（管理区域） ■：その他区域（非管理区域） ■：区域番号</p> <p data-bbox="1209 335 1265 470">制御建屋 IF 0.P. 15000</p>	 <p data-bbox="1769 223 1848 375">泊発電所3号炉 非管理区域及び管理区域（注1） 管理区域の位置（注2）</p> <p data-bbox="1769 853 1848 973">非管理区域（注1） 基本防護区域（注2） その他区域（注3） その他区域（注4） 区域番号</p>	<p data-bbox="1870 175 1982 199">【女川・大阪】</p> <p data-bbox="1870 215 1993 239">設計方針の相違</p> <p data-bbox="1870 247 2128 271">プラント構成及び機器配置の相違</p>

赤字：設備、運用又は体制の相違（設計方針の相違）
 青字：記載箇所又は記載内容の相違（記載方針の相違）
 緑字：記載表現、設備名称の相違（実質的な相違なし）

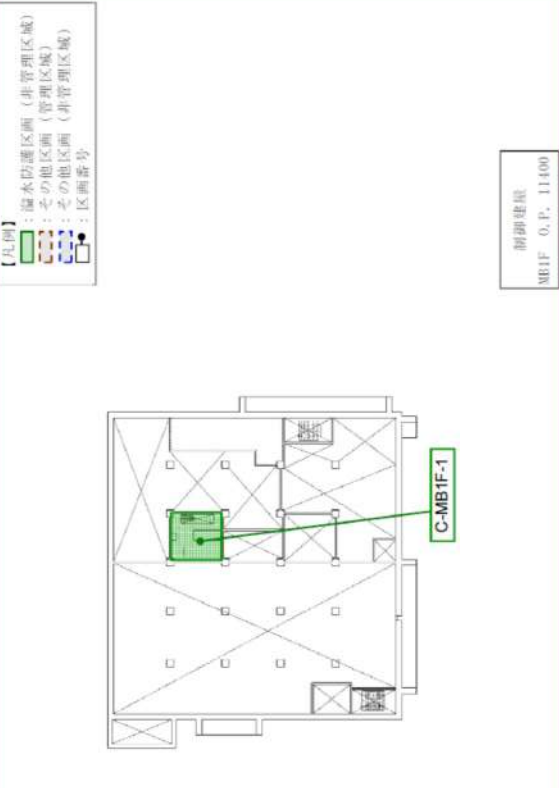
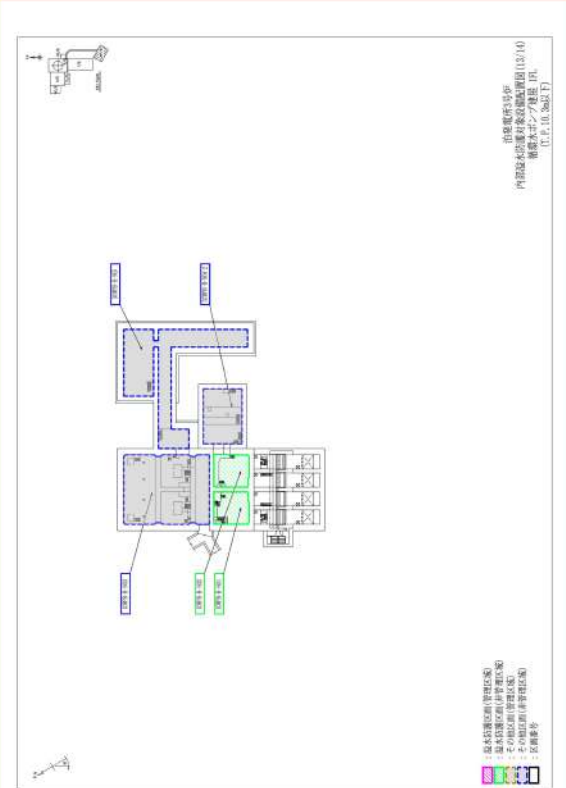
大阪発電所3/4号炉	女川原子力発電所2号炉	泊発電所3号炉	相違理由
 <p data-bbox="116 986 680 1018"> 枠組みの範囲は機密に係る事項ですので公開することはできません。 </p>	 <p data-bbox="707 197 801 472"> 【凡例】 ■：漏水防護区域（非管理区域） ■：その他区域（管理区域） ■：その他区域（非管理区域） ■：区域番号 </p> <p data-bbox="1205 338 1263 478"> 制御室 MB1F 0. P. 11.100 </p>	 <p data-bbox="1765 226 1845 379"> 泊発電所3号炉 内部保安対策実施計画(03/10) 機密本システム取扱手順書 (U.P.10.3682 F) </p> <p data-bbox="1765 852 1845 976"> ■：基本防護区域(管理区域) ■：基本防護区域(非管理区域) ■：その他区域(管理区域) ■：その他区域(非管理区域) ■：区域番号 </p>	<p data-bbox="1872 178 1989 201">【女川・大阪】</p> <p data-bbox="1872 213 1998 236">設計方針の相違</p> <p data-bbox="1872 248 2134 271">プラント構成及び機器配置の相違</p>

赤字：設備、運用又は体制の相違（設計方針の相違）
 青字：記載箇所又は記載内容の相違（記載方針の相違）
 緑字：記載表現、設備名称の相違（実質的な相違なし）

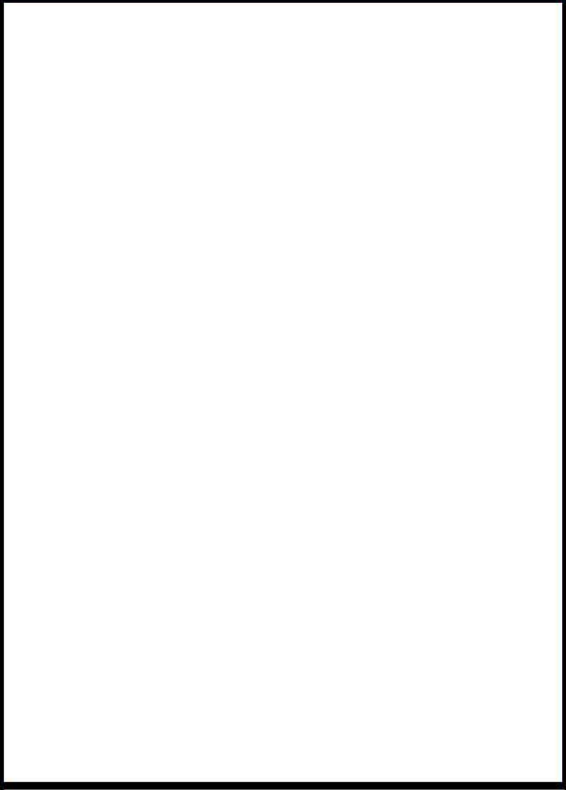
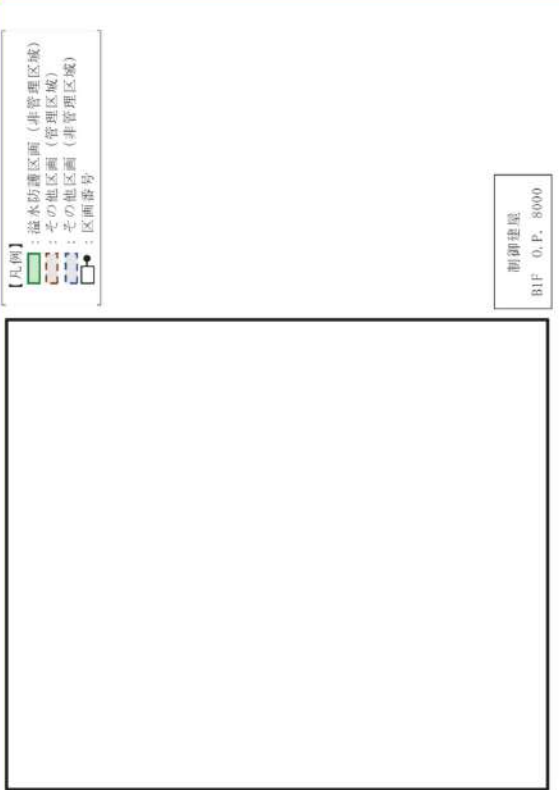
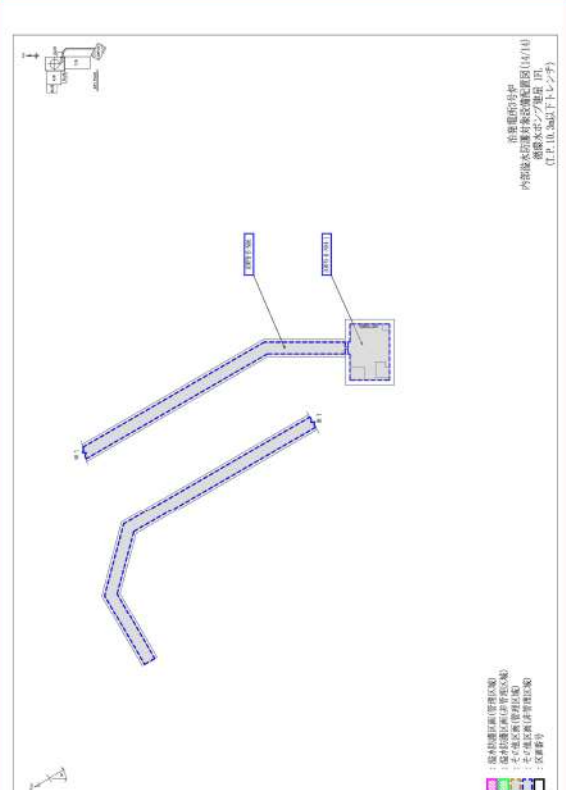
大阪発電所3/4号炉	女川原子力発電所2号炉	泊発電所3号炉	相違理由
 <p data-bbox="116 981 680 1021">枠組みの範囲は機密に係る事項ですので公開することはできません。</p>	 <p data-bbox="707 207 806 478">【凡例】 溢水防護区画（非管理区域） その他区画（管理区域） その他区画（非管理区域） 区画番号</p> <p data-bbox="1198 359 1254 486">制御建屋 BIF 0. P. 8000</p> <p data-bbox="772 981 1254 1021">枠組みの内容は防護上の観点から公開できません。</p>	 <p data-bbox="1290 207 1854 367"> 泊発電所3号炉 内部配水防室好水設備設置区画(0101) 設備名: BIF 0.P. 8000 (注: 図面は上下左右対称) </p> <p data-bbox="1758 853 1854 973"> 溢水防護区画(管理区域) 溢水防護区画(非管理区域) その他区画(管理区域) その他区画(非管理区域) 区画番号 </p>	<p data-bbox="1872 180 2134 263">【女川・大阪】 設計方針の相違 プラント構成及び機器配置の相違</p>

赤字：設備、運用又は体制の相違（設計方針の相違）
 青字：記載箇所又は記載内容の相違（記載方針の相違）
 緑字：記載表現、設備名称の相違（実質的な相違なし）

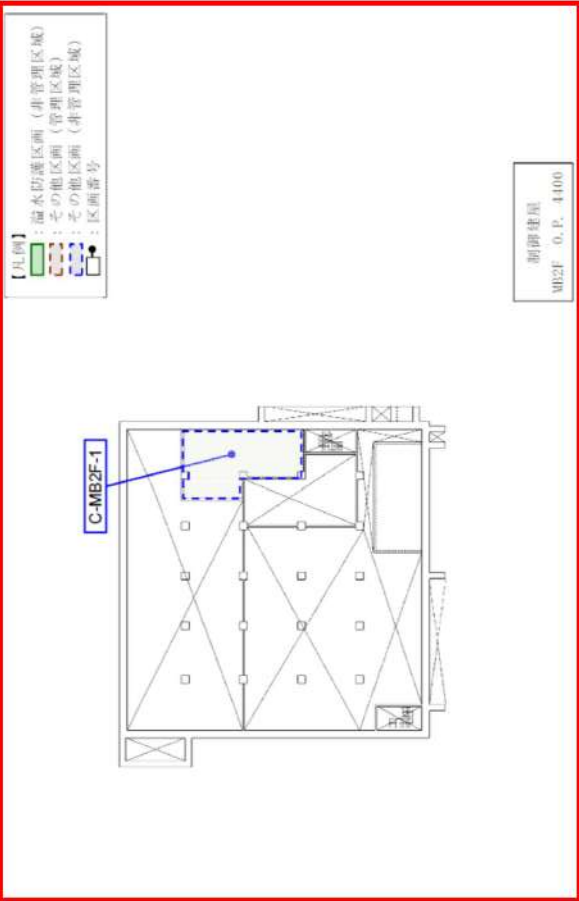
大阪発電所3/4号炉	女川原子力発電所2号炉	泊発電所3号炉	相違理由
			<p>【女川】 <u>設計方針の相違</u> プラント構成及び機器配置の相違</p>

赤字：設備、運用又は体制の相違（設計方針の相違）
 青字：記載箇所又は記載内容の相違（記載方針の相違）
 緑字：記載表現、設備名称の相違（実質的な相違なし）

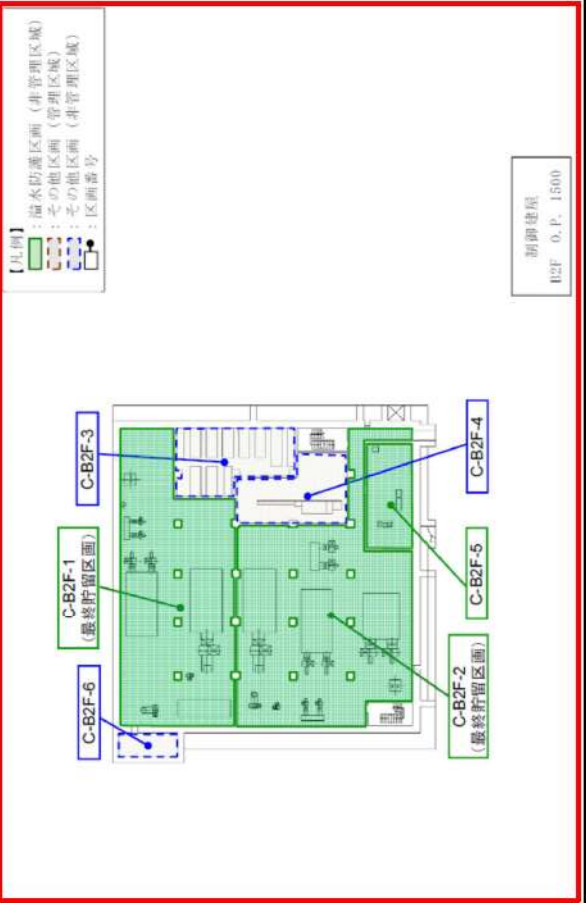
大阪発電所3/4号炉	女川原子力発電所2号炉	泊発電所3号炉	相違理由
			<p>【女川】 設計方針の相違 プラント構成及び機器配置の相違</p>

赤字：設備、運用又は体制の相違（設計方針の相違）
 青字：記載箇所又は記載内容の相違（記載方針の相違）
 緑字：記載表現、設備名称の相違（実質的な相違なし）

大阪発電所3/4号炉	女川原子力発電所2号炉	泊発電所3号炉	相違理由
	<div data-bbox="698 199 795 478" style="border: 1px solid black; padding: 5px;"> <p>【凡例】</p> <p>■：溢水防護区画（非管理区域）</p> <p>□：その他区画（非管理区域）</p> <p>●：区画番号</p> </div> <div data-bbox="1227 347 1261 478" style="border: 1px solid black; padding: 5px; text-align: center;"> <p>揚水ポンプ室</p> </div> <div data-bbox="698 494 1261 981" style="border: 1px solid black; height: 300px; margin: 10px 0;"> </div> <div data-bbox="768 997 1261 1029" style="border: 1px solid black; padding: 5px; text-align: center;"> <p>枠囲みの内容は防護上の観点から公開できません。</p> </div>		<p>【女川】</p> <p>設計方針の相違</p> <p>プラント構成及び機器配置の相違</p>

赤字：設備、運用又は体制の相違（設計方針の相違）
 青字：記載箇所又は記載内容の相違（記載方針の相違）
 緑字：記載表現、設備名称の相違（実質的な相違なし）

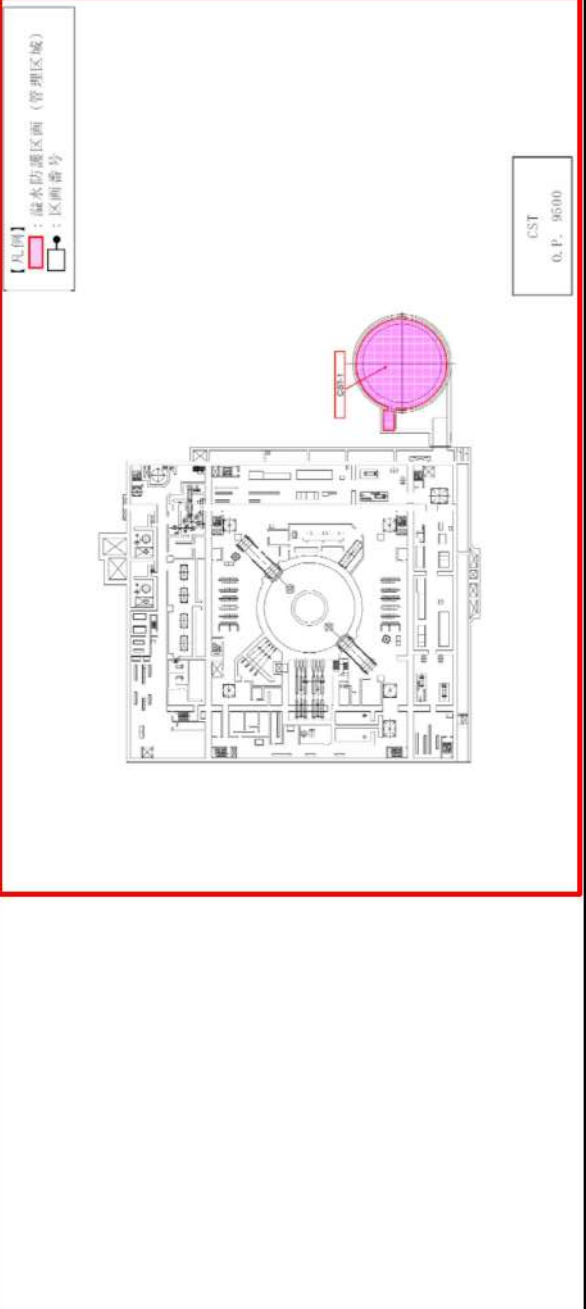
大阪発電所3/4号炉	女川原子力発電所2号炉	泊発電所3号炉	相違理由
			<p>【女川】 設計方針の相違 プラント構成及び機器配置の相違</p>

赤字：設備、運用又は体制の相違（設計方針の相違）
 青字：記載箇所又は記載内容の相違（記載方針の相違）
 緑字：記載表現、設備名称の相違（実質的な相違なし）

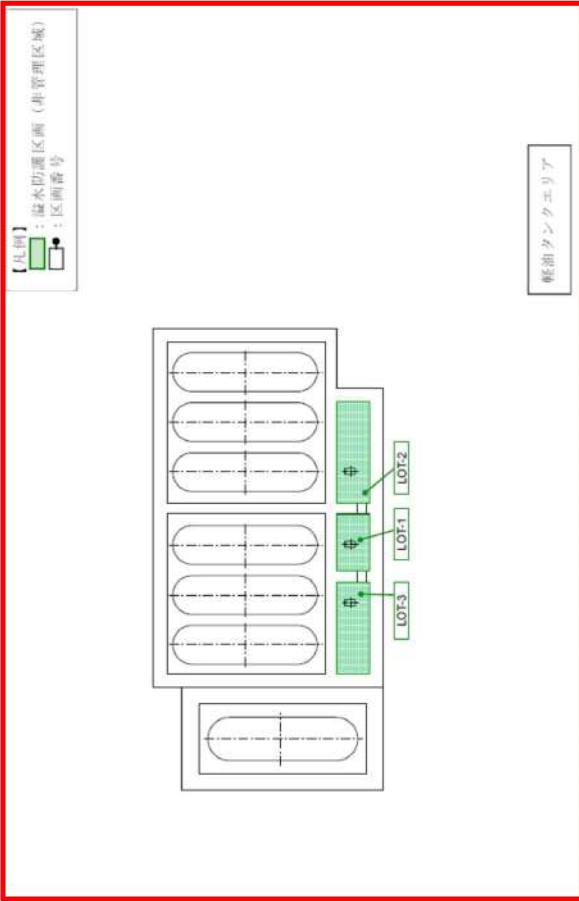
大阪発電所3/4号炉	女川原子力発電所2号炉	泊発電所3号炉	相違理由
			<p>【女川】 設計方針の相違 プラント構成及び機器配置の相違</p>

赤字：設備、運用又は体制の相違 (設計方針の相違)
 青字：記載箇所又は記載内容の相違 (記載方針の相違)
 緑字：記載表現、設備名称の相違 (実質的な相違なし)

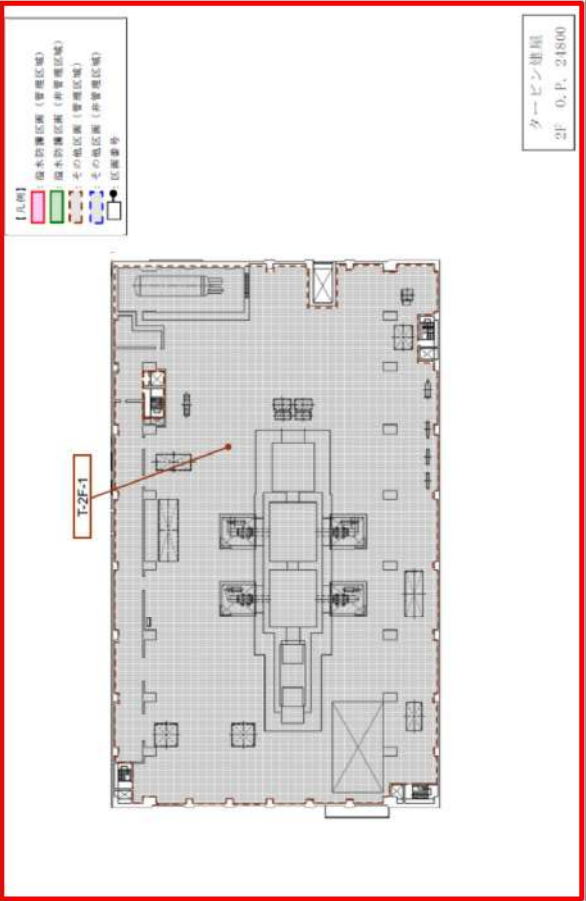
大阪発電所3/4号炉	女川原子力発電所2号炉	泊発電所3号炉	相違理由
			<p>【女川】 設計方針の相違 プラント構成及び機器配置の相違</p>

赤字：設備、運用又は体制の相違（設計方針の相違）
 青字：記載箇所又は記載内容の相違（記載方針の相違）
 緑字：記載表現、設備名称の相違（実質的な相違なし）

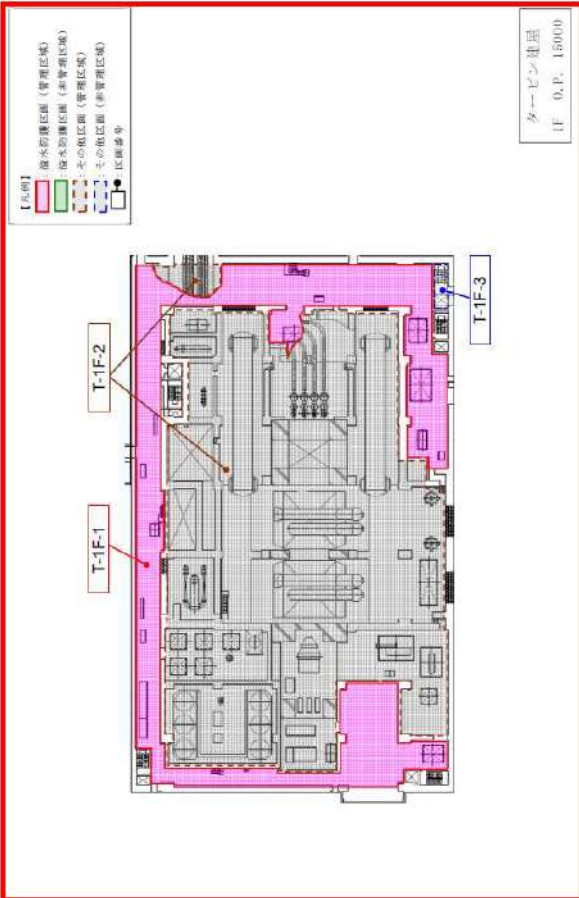
大阪発電所3/4号炉	女川原子力発電所2号炉	泊発電所3号炉	相違理由
			<p>【女川】</p> <p>設計方針の相違</p> <p>プラント構成及び機器配置の相違</p>

赤字：設備、運用又は体制の相違（設計方針の相違）
 青字：記載箇所又は記載内容の相違（記載方針の相違）
 緑字：記載表現、設備名称の相違（実質的な相違なし）

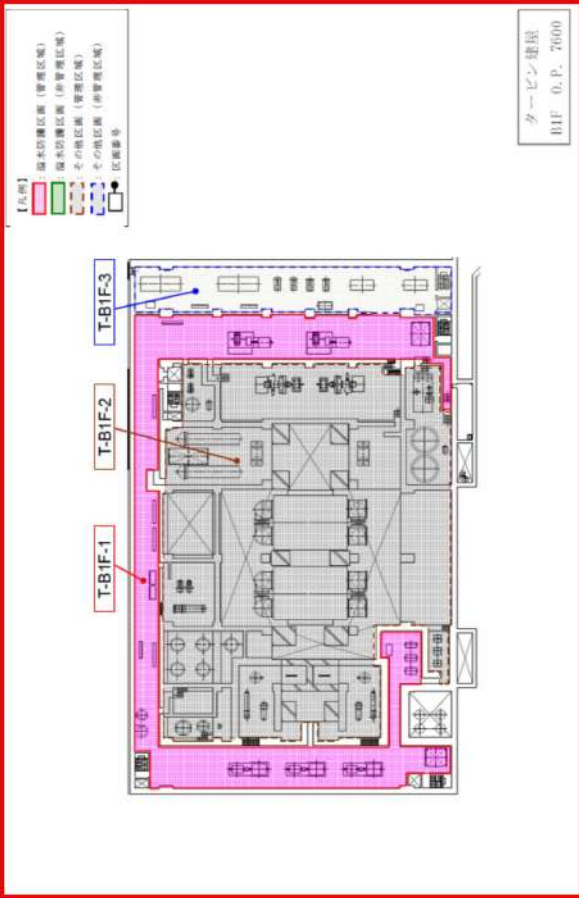
大阪発電所3/4号炉	女川原子力発電所2号炉	泊発電所3号炉	相違理由
			<p>【女川】 設計方針の相違 プラント構成及び機器配置の相違</p>

赤字：設備、運用又は体制の相違（設計方針の相違）
 青字：記載箇所又は記載内容の相違（記載方針の相違）
 緑字：記載表現、設備名称の相違（実質的な相違なし）

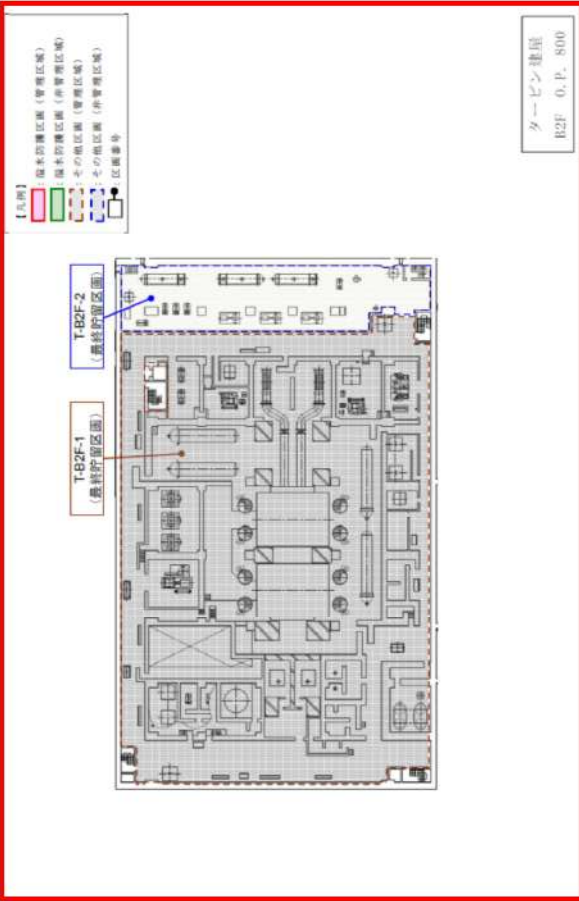
大阪発電所3/4号炉	女川原子力発電所2号炉	泊発電所3号炉	相違理由
			<p>【女川】</p> <p>設計方針の相違</p> <p>プラント構成及び機器配置の相違</p>

赤字：設備、運用又は体制の相違（設計方針の相違）
 青字：記載箇所又は記載内容の相違（記載方針の相違）
 緑字：記載表現、設備名称の相違（実質的な相違なし）

大阪発電所3/4号炉	女川原子力発電所2号炉	泊発電所3号炉	相違理由																															
<p>17 滞留面積の精緻化に伴う没水影響評価について</p> <p>1. はじめに</p> <p>前回の現場調査以降、火災防護設備、重大事故等対処設備、多様性拡張設備等の追加設置に伴い没水影響評価に用いる滞留面積の減少があることから、今回、滞留面積の精緻化を図り没水影響評価について再評価を実施した。</p> <p>2. 没水影響評価</p> <p>没水影響評価に用いる滞留面積の精緻化に伴う没水影響評価の変更については、ゆらぎも含め溢水水位の上昇はわずかであり、防護対象設備が機能喪失しないことを確認した。</p> <p>没水評価結果の例を表1に示す。</p> <p>表1 滞留面積を精緻化の伴う没水影響評価について（例）</p> <table border="1" data-bbox="129 726 654 949"> <thead> <tr> <th colspan="8">原子炉周辺建屋 E.L.+10.0m 非管理区域 3EB-N12A 自動スプリンクラー</th> </tr> <tr> <th></th> <th>① 溢水量 [m³]</th> <th>② 滞留面積 [m²]</th> <th>床勾配 [m]</th> <th>③ 溢水水位 [m]</th> <th>防護対象設備</th> <th>④ 機能喪失高さ [m]</th> <th>⑤ 影響評価</th> <th>⑥ 判定</th> </tr> </thead> <tbody> <tr> <td>変更前</td> <td>21.6</td> <td>165.7</td> <td>0.00</td> <td>0.131</td> <td rowspan="2">3A、3B 制御用空気圧縮機制御盤 (3IAC-A、B)</td> <td rowspan="2">0.44</td> <td rowspan="2">③<④</td> <td rowspan="2">○</td> </tr> <tr> <td>変更後</td> <td></td> <td>71.8</td> <td>0.00</td> <td>0.301</td> </tr> </tbody> </table>	原子炉周辺建屋 E.L.+10.0m 非管理区域 3EB-N12A 自動スプリンクラー									① 溢水量 [m ³]	② 滞留面積 [m ²]	床勾配 [m]	③ 溢水水位 [m]	防護対象設備	④ 機能喪失高さ [m]	⑤ 影響評価	⑥ 判定	変更前	21.6	165.7	0.00	0.131	3A、3B 制御用空気圧縮機制御盤 (3IAC-A、B)	0.44	③<④	○	変更後		71.8	0.00	0.301	<p>添付資料8</p> <p>滞留面積の算出について</p> <p>1. 滞留面積の算出要領</p> <p>滞留面積については、没水影響評価結果に与える影響が大きいため、以下のような条件にて算出することを基本とし、評価における保守性を確保する。</p>	<p>添付資料8</p> <p>滞留面積の算出について</p> <p>1. 滞留面積の算出要領</p> <p>滞留面積については、没水影響評価結果に与える影響が大きいため、以下のような条件にて算出することとし、評価における保守性を確保する。</p> <p>(1) 算出方法</p> <p>a. 滞留面積の算出エリアを設定し、その内側の面積を算出する。(以下「全面積」という)</p> <p>b. エリア内側にあるコンクリート基礎、柱、ピット、スロープ、床開口等、欠損となるコンクリート構造物の面積を算出する。(以下「基礎等欠損面積」という)</p> <p>c. 常設機器、現場資機材、床貫通部等、滞留面積の欠損となるものの面積を現場調査により算出する。(以下「現場調査欠損面積」という)</p> <p>d. 上記 a. で算出した面積より、b. 及び c. の欠損面積を差し引く。この結果を没水評価に用いる滞留面積とする。</p>	<p>【大阪】</p> <p><u>記載方針の相違</u></p> <p>大阪は没水評価実施後に追加設置した設備等による滞留面積の減少分を精緻化して没水評価の再評価を実施していることを説明しているが、滞留面積の算出方法は泊と同様であり、欠損面積を現場実測している。</p> <p>【女川】</p> <p><u>設計方針の相違</u></p> <p>泊は全エリアに対して同様の算出方法としていることから「基本」という記載はしていない。</p> <p>【女川・大阪】</p> <p><u>記載方針の相違</u></p> <p>泊は滞留面積の算出過程が明確となるよう、最初に算出方法を記載する構成としている。</p> <p>【女川】</p> <p><u>設計方針の相違</u></p> <p>泊は滞留面積の算出エリアの面積及びエリア内にある基礎等のコンクリート構造物は建築図面より算出し、評価に用いる滞留面積が現場の実態に即した精緻なものとなるよう、常設機器等の欠損面積を現場実測により算出している。</p> <p>(大阪3/4号炉、美浜3号炉、高浜1/2/3/4号炉と同様)</p>
原子炉周辺建屋 E.L.+10.0m 非管理区域 3EB-N12A 自動スプリンクラー																																		
	① 溢水量 [m ³]	② 滞留面積 [m ²]	床勾配 [m]	③ 溢水水位 [m]	防護対象設備	④ 機能喪失高さ [m]	⑤ 影響評価	⑥ 判定																										
変更前	21.6	165.7	0.00	0.131	3A、3B 制御用空気圧縮機制御盤 (3IAC-A、B)	0.44	③<④	○																										
変更後		71.8	0.00	0.301																														

赤字：設備、運用又は体制の相違（設計方針の相違）
 青字：記載箇所又は記載内容の相違（記載方針の相違）
 緑字：記載表現、設備名称の相違（実質的な相違なし）

大阪発電所3/4号炉	女川原子力発電所2号炉	泊発電所3号炉	相違理由
	<p>(1) インプット</p> <p>a. 原則として、床躯体図を用いて躯体寸法を読み取り、手計算にて床面積を算出する。</p> <p>b. 一部形状が複雑なエリアは計算が複雑となることから、CADデータを使用し床面積を算出する。</p> <p>(2) 算出範囲</p> <p>a. 壁、柱等で囲まれた範囲を単位区画として面積を算出する。(図1参照)</p> <p>b. アクセス開口及び迷路部等は床面積から除く。(図1参照)</p> <p>c. サンプ等、基準床面より掘り込んでいる部分については、有効な床面積として算出する。(図2参照)</p>	<p>(2) インプット</p> <p>a. 全面積及び基礎等欠損面積は、建築図（コンクリート形状図）を用いて躯体寸法を読み取り、手計算にて床面積を算出する。</p> <p>b. 現場調査欠損面積は、現場調査により対象となる機器等の寸法を実測し、欠損面積を算出する。</p> <p>(3) 算出範囲</p> <p>a. 壁、柱等で囲まれた範囲を単位区画として面積を算出する。(図1参照)</p> <p>b. コンクリート基礎、柱、ビット、スロープ、床開口は床面積から除く。(図1参照)</p>	<p>【女川】</p> <p><u>設計方針の相違</u></p> <p>泊は全エリアに対して同様の算出方法としていることから「原則」という記載はしていない。</p> <p><u>記載表現の相違</u></p> <p>【女川】</p> <p><u>設計方針の相違</u></p> <p>泊は滞留面積の算出エリアの面積及びエリア内にある基礎等のコンクリート構造物は建築図面より算出し、評価に用いる滞留面積が現場の実態に即した精緻なものとなるよう、常設機器等の欠損面積を現場実測により算出している。</p> <p>(大阪3/4号炉、美浜3号炉、高浜1/2/3/4号炉と同様)</p> <p>【女川】</p> <p><u>記載表現の相違</u></p> <p><u>設計方針の相違</u></p> <ul style="list-style-type: none"> 泊では迷路部も床面積として算出している。(大阪3/4号炉、美浜3号炉、高浜1/2/3/4号炉と同様) また、ビットは欠損面積として扱っており、有効な床面積として含んでいない。(大阪3/4号炉、美浜3号炉、高浜1/2/3/4号炉と同様)

赤字：設備、運用又は体制の相違（設計方針の相違）
 青字：記載箇所又は記載内容の相違（記載方針の相違）
 緑字：記載表現、設備名称の相違（実質的な相違なし）



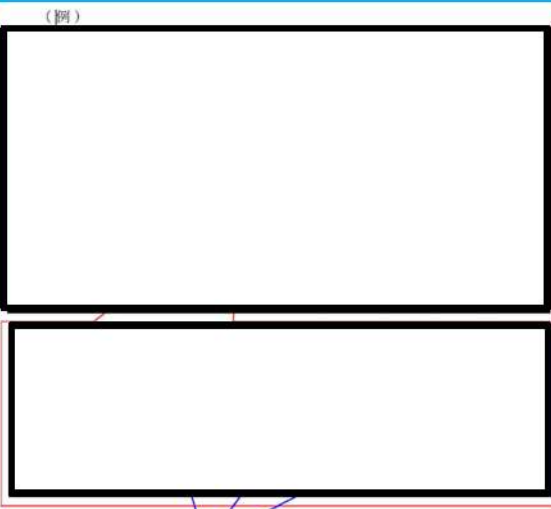
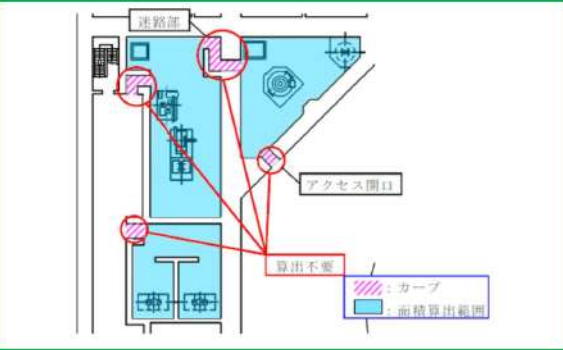
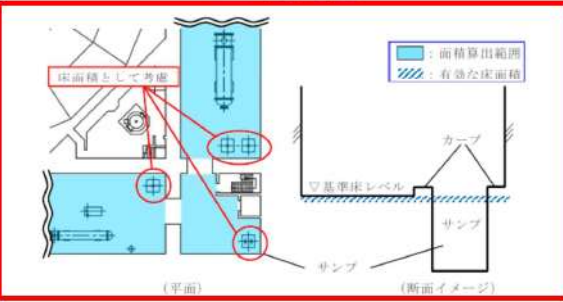
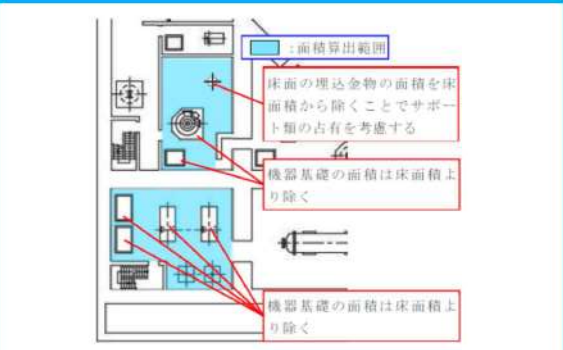
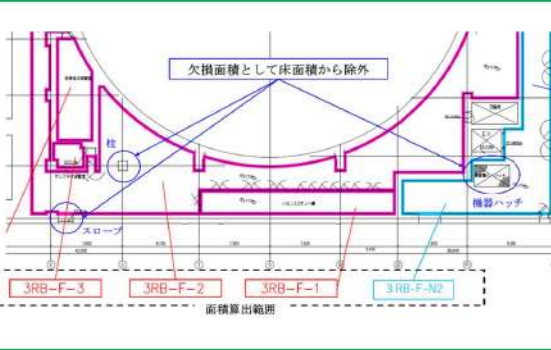

大阪発電所3/4号炉	女川原子力発電所2号炉	泊発電所3号炉	相違理由																																																																																																																																																																								
	<p>(3) 通常評価</p> <p>没水評価を実施する際は、原則として、算出した床面積の値に0.7倍した値を使用する。基準床面より盛り上がっている部分（機器基礎、床ハッチ、スロープ、ランプ周りのカーブ、サポート類等）は0.7の係数に含まれるものとする。ただし、床面積に対して機器基礎の占有率が30%以上となる区画は、占有率に応じた係数を使用する。機器基礎の占有率に応じた係数使用区画について表1に示す。</p> <p style="text-align: center;">表1 機器基礎の占有率に応じた係数使用区画</p> <table border="1" data-bbox="696 518 1272 906"> <thead> <tr> <th>No.</th> <th>区画番号</th> <th>棟屋</th> <th>フロア</th> <th>床面積 [㎡]</th> <th>機器基礎面積 [㎡]</th> <th>機器基礎の占有率 [%]</th> <th>使用する係数</th> <th>エリア名称</th> </tr> </thead> <tbody> <tr><td>1</td><td>R-B1F-12</td><td>R/B</td><td>B1F</td><td>102.6</td><td>33.5</td><td>33.0</td><td>0.65</td><td>区分II非常用MCC室</td></tr> <tr><td>2</td><td>R-1F-15</td><td>R/B</td><td>1F</td><td>200.9</td><td>65.2</td><td>33.0</td><td>0.65</td><td>D/G (MPCS) 室</td></tr> <tr><td>3</td><td>R-2F-2-2</td><td>R/B</td><td>2F</td><td>50.4</td><td>15.7</td><td>32.0</td><td>0.65</td><td>FCS 西結合装置 (A) 室</td></tr> <tr><td>4</td><td>R-2F-2-3</td><td>R/B</td><td>2F</td><td>50.4</td><td>15.7</td><td>32.0</td><td>0.65</td><td>FCS 西結合装置 (B) 室</td></tr> <tr><td>5</td><td>R-2F-2-5</td><td>R/B</td><td>2F</td><td>14.5</td><td>5.3</td><td>37.0</td><td>0.6</td><td>CAMS フック (A) 室</td></tr> <tr><td>6</td><td>R-2F-2-6</td><td>R/B</td><td>2F</td><td>14.5</td><td>5.3</td><td>37.0</td><td>0.6</td><td>CAMS フック (B) 室</td></tr> <tr><td>7</td><td>R-2F-13-1</td><td>R/B</td><td>2F</td><td>33.1</td><td>11.6</td><td>36.0</td><td>0.6</td><td>D/G (A) 非常用送風機室</td></tr> <tr><td>8</td><td>R-2F-17</td><td>R/B</td><td>2F</td><td>27.4</td><td>10.2</td><td>38.0</td><td>0.6</td><td>燃料デイトンク (A) 室</td></tr> <tr><td>9</td><td>R-2F-18</td><td>R/B</td><td>2F</td><td>32.1</td><td>10.2</td><td>32.0</td><td>0.65</td><td>燃料デイトンク (B) 室</td></tr> <tr><td>10</td><td>R-2F-19</td><td>R/B</td><td>2F</td><td>27.7</td><td>9.1</td><td>33.0</td><td>0.65</td><td>燃料デイトンク (MPCS) 室</td></tr> <tr><td>11</td><td>C-B2F-3</td><td>C/B</td><td>B2F</td><td>113.7</td><td>57.9</td><td>51.0</td><td>0.45</td><td>DC250V バッテリー室</td></tr> <tr><td>12</td><td>C-B1F-2</td><td>C/B</td><td>B1F</td><td>44.4</td><td>13.7</td><td>31.0</td><td>0.65</td><td>DC125V バッテリー室 (A)</td></tr> <tr><td>13</td><td>C-B1F-4</td><td>C/B</td><td>B1F</td><td>70.3</td><td>28.0</td><td>40.0</td><td>0.55</td><td>DC125V バッテリー室 (B)</td></tr> <tr><td>14</td><td>C-B1F-5</td><td>C/B</td><td>B1F</td><td>211.8</td><td>62.1</td><td>30.0</td><td>0.65</td><td>計測制御電機室 (B)</td></tr> <tr><td>15</td><td>C-B1F-6-1</td><td>C/B</td><td>B1F</td><td>32.5</td><td>10.1</td><td>32.0</td><td>0.65</td><td>ISS 盤室</td></tr> </tbody> </table> <p>(4) 詳細評価</p> <p>最終的な溢水の滞留先となる最地下階の共通エリアや、復水器室等の機器の占有率が大きいエリアについては、詳細に算出した面積を使用する。(図3参照)</p> <p>対象とする区画は表2のとおり。</p> <p style="text-align: center;">表2 詳細に面積を算出した区画</p> <table border="1" data-bbox="696 1201 1272 1385"> <thead> <tr> <th>No.</th> <th>区画番号</th> <th>床面積 [㎡]</th> <th>機器基礎面積 [㎡]</th> <th>埋込金物面積 [㎡]</th> <th>合計面積 [㎡]</th> </tr> </thead> <tbody> <tr><td>1</td><td>R-B3F-1</td><td>156.7</td><td>0.4</td><td>1.0</td><td>155.3</td></tr> <tr><td>2</td><td>R-B3F-12</td><td>70.8</td><td>0</td><td>0</td><td>70.8</td></tr> <tr><td>3</td><td>復水器室[※]</td><td>1621.5</td><td>286.0</td><td>73.0</td><td>1262.5</td></tr> </tbody> </table> <p>※ 復水器室は T-B2F-1 の面積に含め、没水評価で使用している。</p>	No.	区画番号	棟屋	フロア	床面積 [㎡]	機器基礎面積 [㎡]	機器基礎の占有率 [%]	使用する係数	エリア名称	1	R-B1F-12	R/B	B1F	102.6	33.5	33.0	0.65	区分II非常用MCC室	2	R-1F-15	R/B	1F	200.9	65.2	33.0	0.65	D/G (MPCS) 室	3	R-2F-2-2	R/B	2F	50.4	15.7	32.0	0.65	FCS 西結合装置 (A) 室	4	R-2F-2-3	R/B	2F	50.4	15.7	32.0	0.65	FCS 西結合装置 (B) 室	5	R-2F-2-5	R/B	2F	14.5	5.3	37.0	0.6	CAMS フック (A) 室	6	R-2F-2-6	R/B	2F	14.5	5.3	37.0	0.6	CAMS フック (B) 室	7	R-2F-13-1	R/B	2F	33.1	11.6	36.0	0.6	D/G (A) 非常用送風機室	8	R-2F-17	R/B	2F	27.4	10.2	38.0	0.6	燃料デイトンク (A) 室	9	R-2F-18	R/B	2F	32.1	10.2	32.0	0.65	燃料デイトンク (B) 室	10	R-2F-19	R/B	2F	27.7	9.1	33.0	0.65	燃料デイトンク (MPCS) 室	11	C-B2F-3	C/B	B2F	113.7	57.9	51.0	0.45	DC250V バッテリー室	12	C-B1F-2	C/B	B1F	44.4	13.7	31.0	0.65	DC125V バッテリー室 (A)	13	C-B1F-4	C/B	B1F	70.3	28.0	40.0	0.55	DC125V バッテリー室 (B)	14	C-B1F-5	C/B	B1F	211.8	62.1	30.0	0.65	計測制御電機室 (B)	15	C-B1F-6-1	C/B	B1F	32.5	10.1	32.0	0.65	ISS 盤室	No.	区画番号	床面積 [㎡]	機器基礎面積 [㎡]	埋込金物面積 [㎡]	合計面積 [㎡]	1	R-B3F-1	156.7	0.4	1.0	155.3	2	R-B3F-12	70.8	0	0	70.8	3	復水器室 [※]	1621.5	286.0	73.0	1262.5	<p>(4) 現場調査欠損面積の算出</p> <p>現場調査欠損面積は、現場実測により算出した欠損面積に対し、すべてのエリアにおいて一律に25%の割り増しを行う。現場調査による欠損面積の対象外とした0.01㎡未満の機器は割り増しに含まれるものとする。</p> <p>現場調査欠損面積の現場実測の例を図2に示す。</p>	<p>【女川】</p> <p><u>記載表現の相違</u> <u>設計方針の相違</u></p> <p>・女川は床面積に対する機器等の占有率に応じて通常評価又は詳細評価を実施しているのに対し、泊は全エリアに対して同様の算出方法としている。</p> <p>・また、女川は滞留面積の算出時に係数を乗じることで保守性を確保しているのに対し、泊は全区画の欠損面積を一律に25%割り増しすることで保守性を確保している。</p> <p>【女川】</p> <p><u>設計方針の相違</u></p> <p>同上</p>
No.	区画番号	棟屋	フロア	床面積 [㎡]	機器基礎面積 [㎡]	機器基礎の占有率 [%]	使用する係数	エリア名称																																																																																																																																																																			
1	R-B1F-12	R/B	B1F	102.6	33.5	33.0	0.65	区分II非常用MCC室																																																																																																																																																																			
2	R-1F-15	R/B	1F	200.9	65.2	33.0	0.65	D/G (MPCS) 室																																																																																																																																																																			
3	R-2F-2-2	R/B	2F	50.4	15.7	32.0	0.65	FCS 西結合装置 (A) 室																																																																																																																																																																			
4	R-2F-2-3	R/B	2F	50.4	15.7	32.0	0.65	FCS 西結合装置 (B) 室																																																																																																																																																																			
5	R-2F-2-5	R/B	2F	14.5	5.3	37.0	0.6	CAMS フック (A) 室																																																																																																																																																																			
6	R-2F-2-6	R/B	2F	14.5	5.3	37.0	0.6	CAMS フック (B) 室																																																																																																																																																																			
7	R-2F-13-1	R/B	2F	33.1	11.6	36.0	0.6	D/G (A) 非常用送風機室																																																																																																																																																																			
8	R-2F-17	R/B	2F	27.4	10.2	38.0	0.6	燃料デイトンク (A) 室																																																																																																																																																																			
9	R-2F-18	R/B	2F	32.1	10.2	32.0	0.65	燃料デイトンク (B) 室																																																																																																																																																																			
10	R-2F-19	R/B	2F	27.7	9.1	33.0	0.65	燃料デイトンク (MPCS) 室																																																																																																																																																																			
11	C-B2F-3	C/B	B2F	113.7	57.9	51.0	0.45	DC250V バッテリー室																																																																																																																																																																			
12	C-B1F-2	C/B	B1F	44.4	13.7	31.0	0.65	DC125V バッテリー室 (A)																																																																																																																																																																			
13	C-B1F-4	C/B	B1F	70.3	28.0	40.0	0.55	DC125V バッテリー室 (B)																																																																																																																																																																			
14	C-B1F-5	C/B	B1F	211.8	62.1	30.0	0.65	計測制御電機室 (B)																																																																																																																																																																			
15	C-B1F-6-1	C/B	B1F	32.5	10.1	32.0	0.65	ISS 盤室																																																																																																																																																																			
No.	区画番号	床面積 [㎡]	機器基礎面積 [㎡]	埋込金物面積 [㎡]	合計面積 [㎡]																																																																																																																																																																						
1	R-B3F-1	156.7	0.4	1.0	155.3																																																																																																																																																																						
2	R-B3F-12	70.8	0	0	70.8																																																																																																																																																																						
3	復水器室 [※]	1621.5	286.0	73.0	1262.5																																																																																																																																																																						

赤字：設備、運用又は体制の相違（設計方針の相違）
 青字：記載箇所又は記載内容の相違（記載方針の相違）
 緑字：記載表現、設備名称の相違（実質的な相違なし）

大阪発電所3/4号炉	女川原子力発電所2号炉	泊発電所3号炉	相違理由
<p>9 スロープ部の滞留面積の考え方について</p> <p>大阪発電所の現場にあるスロープ部の考え方については、図1のとおり、スロープ部全面及びフロアレベルよりも高い床面は、滞留面積から除いて評価している。</p>  <p>（例）</p> <p>3号炉 E.L.+26.0m 北側通路部には、勾配が76cmのスロープがあるため、スロープ部全面及びフロアレベルよりも高い床面は、滞留面積から除いている。</p> <p>図1 スロープ部の滞留面積の考え方</p> <p>枠囲みの範囲は機密に係る事項のため、公開できません。</p>	<p>（5）数値処理</p> <p>面積の算出は「m²」単位で行い、小数第2位を切り捨てる。（床面積算出後に切り捨てを実施し、更に0.7倍後に切り捨てる。）</p>  <p>図1 面積算出範囲</p>  <p>図2 掘り込み部の扱い （例：最地下階サンプ）</p>  <p>図3 詳細に床面積を算出する場合の算出範囲（例）</p>	<p>（5）数値処理</p> <p>面積の算出は「m²」単位で行い、小数第2位を切り捨てる。</p>  <p>図1 面積算出範囲</p>	<p>【女川】 設計方針の相違 泊では最終的な滞留面積算出時に切り捨て処理を行っている。</p> <p>【大阪】 記載方針の相違 女川審査実績の反映</p> <p>【女川】 記載表現の相違 建屋構成の違いによる</p> <p>【女川】 設計方針の相違 泊ではビットは欠損面積として扱っており、有効な床面積として含んでいない。</p> <p>【女川】 記載方針の相違 泊ではすべてのエリアに対して同様の算出方法により滞留面積を算出していることから、女川のように「通常評価」と「詳細評価」の区別は無いが、機器基礎を床面積から除外していることは同様である。</p>

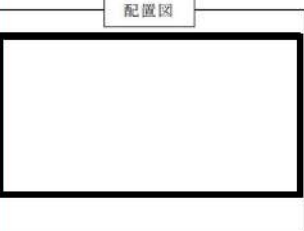
赤字：設備、運用又は体制の相違（設計方針の相違）
 青字：記載箇所又は記載内容の相違（記載方針の相違）
 緑字：記載表現、設備名称の相違（実質的な相違なし）

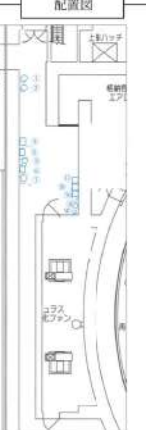
第9条 溢水による損傷の防止等（別添1 添付資料8）

大阪発電所3/4号炉	女川原子力発電所2号炉	泊発電所3号炉	相違理由																																																																																																																																																																																						
<p>(17 滞留面積の精緻化に伴う没水影響評価について)</p> <p>(例) 大災防護設備(盤)</p> <p>大阪3号炉 床面積精緻化に伴う対象物の調査結果</p> <table border="1" data-bbox="152 359 672 582"> <caption>管理表</caption> <thead> <tr> <th rowspan="2">番号</th> <th rowspan="2">対象物 種類</th> <th colspan="2">測定寸法(mm)</th> <th rowspan="2">欠損面積 (m²)</th> <th rowspan="2">備考</th> </tr> <tr> <th>形状 縦</th> <th>横</th> </tr> </thead> <tbody> <tr> <td>033 ①</td> <td>土台</td> <td>650mm</td> <td>410mm</td> <td>0.267m²</td> <td>盤1種</td> </tr> <tr> <td>033 ②</td> <td>土台</td> <td>650mm</td> <td>410mm</td> <td>0.267m²</td> <td>盤1種</td> </tr> <tr> <td>033 ③</td> <td>土台</td> <td>650mm</td> <td>410mm</td> <td>0.267m²</td> <td>盤1種</td> </tr> <tr> <td>033 ④</td> <td>土台</td> <td>650mm</td> <td>410mm</td> <td>0.267m²</td> <td>盤1種</td> </tr> <tr> <td>034 ①</td> <td>土台</td> <td>650mm</td> <td>410mm</td> <td>0.267m²</td> <td>盤1種</td> </tr> <tr> <td>034 ②</td> <td>土台</td> <td>650mm</td> <td>410mm</td> <td>0.267m²</td> <td>盤1種</td> </tr> </tbody> </table> <p>配置図</p>  <p>写真</p>  <p>No. 33①～④</p> <p>No. 34①～②</p>	番号	対象物 種類	測定寸法(mm)		欠損面積 (m ²)	備考	形状 縦	横	033 ①	土台	650mm	410mm	0.267m ²	盤1種	033 ②	土台	650mm	410mm	0.267m ²	盤1種	033 ③	土台	650mm	410mm	0.267m ²	盤1種	033 ④	土台	650mm	410mm	0.267m ²	盤1種	034 ①	土台	650mm	410mm	0.267m ²	盤1種	034 ②	土台	650mm	410mm	0.267m ²	盤1種		<p>(例) 原子炉建屋 33.1m 3RB-C-1_通路, エアロック室①</p> <table border="1" data-bbox="1288 263 1848 550"> <caption>管理表</caption> <thead> <tr> <th rowspan="2">No.</th> <th rowspan="2">設備名称</th> <th colspan="2">形状</th> <th colspan="2">寸法</th> <th colspan="2">材質</th> <th rowspan="2">床面積</th> <th rowspan="2">床高</th> <th rowspan="2">床面</th> </tr> <tr> <th>縦</th> <th>横</th> <th>縦</th> <th>横</th> <th>材質</th> <th>寸法</th> </tr> </thead> <tbody> <tr> <td>1</td> <td>床</td> <td>300</td> <td>300</td> <td>0.09</td> <td>0.09</td> <td>鉄板</td> <td>鉄板</td> <td>0</td> <td>0</td> <td>0</td> </tr> <tr> <td>2</td> <td>床</td> <td>300</td> <td>300</td> <td>0.09</td> <td>0.09</td> <td>鉄板</td> <td>鉄板</td> <td>0</td> <td>0</td> <td>0</td> </tr> <tr> <td>3</td> <td>床</td> <td>300</td> <td>300</td> <td>0.09</td> <td>0.09</td> <td>鉄板</td> <td>鉄板</td> <td>0</td> <td>0</td> <td>0</td> </tr> <tr> <td>4</td> <td>床</td> <td>300</td> <td>300</td> <td>0.09</td> <td>0.09</td> <td>鉄板</td> <td>鉄板</td> <td>0</td> <td>0</td> <td>0</td> </tr> <tr> <td>5</td> <td>床</td> <td>300</td> <td>300</td> <td>0.09</td> <td>0.09</td> <td>鉄板</td> <td>鉄板</td> <td>0</td> <td>0</td> <td>0</td> </tr> <tr> <td>6</td> <td>床</td> <td>300</td> <td>300</td> <td>0.09</td> <td>0.09</td> <td>鉄板</td> <td>鉄板</td> <td>0</td> <td>0</td> <td>0</td> </tr> <tr> <td>7</td> <td>床</td> <td>300</td> <td>300</td> <td>0.09</td> <td>0.09</td> <td>鉄板</td> <td>鉄板</td> <td>0</td> <td>0</td> <td>0</td> </tr> <tr> <td>8</td> <td>床</td> <td>300</td> <td>300</td> <td>0.09</td> <td>0.09</td> <td>鉄板</td> <td>鉄板</td> <td>0</td> <td>0</td> <td>0</td> </tr> <tr> <td>9</td> <td>床</td> <td>300</td> <td>300</td> <td>0.09</td> <td>0.09</td> <td>鉄板</td> <td>鉄板</td> <td>0</td> <td>0</td> <td>0</td> </tr> <tr> <td>10</td> <td>床</td> <td>300</td> <td>300</td> <td>0.09</td> <td>0.09</td> <td>鉄板</td> <td>鉄板</td> <td>0</td> <td>0</td> <td>0</td> </tr> <tr> <td>11</td> <td>床</td> <td>300</td> <td>300</td> <td>0.09</td> <td>0.09</td> <td>鉄板</td> <td>鉄板</td> <td>0</td> <td>0</td> <td>0</td> </tr> </tbody> </table> <p>配置図</p>  <p>写真</p>  <p>No. 1, 2</p> <p>No. 3</p> <p>No. 4</p> <p>No. 5</p> <p>No. 6</p> <p>No. 7</p>	No.	設備名称	形状		寸法		材質		床面積	床高	床面	縦	横	縦	横	材質	寸法	1	床	300	300	0.09	0.09	鉄板	鉄板	0	0	0	2	床	300	300	0.09	0.09	鉄板	鉄板	0	0	0	3	床	300	300	0.09	0.09	鉄板	鉄板	0	0	0	4	床	300	300	0.09	0.09	鉄板	鉄板	0	0	0	5	床	300	300	0.09	0.09	鉄板	鉄板	0	0	0	6	床	300	300	0.09	0.09	鉄板	鉄板	0	0	0	7	床	300	300	0.09	0.09	鉄板	鉄板	0	0	0	8	床	300	300	0.09	0.09	鉄板	鉄板	0	0	0	9	床	300	300	0.09	0.09	鉄板	鉄板	0	0	0	10	床	300	300	0.09	0.09	鉄板	鉄板	0	0	0	11	床	300	300	0.09	0.09	鉄板	鉄板	0	0	0	<p>【女川】 記載方針の相違 泊では常設機器等の欠損面積を現場実測により算出していることから、現場実測の例を図2に示している。</p> <p>【大阪】 記載表現の相違</p>
番号			対象物 種類	測定寸法(mm)			欠損面積 (m ²)	備考																																																																																																																																																																																	
	形状 縦	横																																																																																																																																																																																							
033 ①	土台	650mm	410mm	0.267m ²	盤1種																																																																																																																																																																																				
033 ②	土台	650mm	410mm	0.267m ²	盤1種																																																																																																																																																																																				
033 ③	土台	650mm	410mm	0.267m ²	盤1種																																																																																																																																																																																				
033 ④	土台	650mm	410mm	0.267m ²	盤1種																																																																																																																																																																																				
034 ①	土台	650mm	410mm	0.267m ²	盤1種																																																																																																																																																																																				
034 ②	土台	650mm	410mm	0.267m ²	盤1種																																																																																																																																																																																				
No.	設備名称	形状		寸法		材質		床面積	床高	床面																																																																																																																																																																															
		縦	横	縦	横	材質	寸法																																																																																																																																																																																		
1	床	300	300	0.09	0.09	鉄板	鉄板	0	0	0																																																																																																																																																																															
2	床	300	300	0.09	0.09	鉄板	鉄板	0	0	0																																																																																																																																																																															
3	床	300	300	0.09	0.09	鉄板	鉄板	0	0	0																																																																																																																																																																															
4	床	300	300	0.09	0.09	鉄板	鉄板	0	0	0																																																																																																																																																																															
5	床	300	300	0.09	0.09	鉄板	鉄板	0	0	0																																																																																																																																																																															
6	床	300	300	0.09	0.09	鉄板	鉄板	0	0	0																																																																																																																																																																															
7	床	300	300	0.09	0.09	鉄板	鉄板	0	0	0																																																																																																																																																																															
8	床	300	300	0.09	0.09	鉄板	鉄板	0	0	0																																																																																																																																																																															
9	床	300	300	0.09	0.09	鉄板	鉄板	0	0	0																																																																																																																																																																															
10	床	300	300	0.09	0.09	鉄板	鉄板	0	0	0																																																																																																																																																																															
11	床	300	300	0.09	0.09	鉄板	鉄板	0	0	0																																																																																																																																																																															
<p>図1 滞留面積精緻化に伴う資料について</p> <p>枠囲みの範囲は機密に係る事項のため、公開できません。</p>		<p>図2 床面積欠損対象物の測定結果例</p>																																																																																																																																																																																							

泊発電所3号炉 D B基準適合性 比較表

第9条 溢水による損傷の防止等 (別添1 添付資料9)

赤字：設備、運用又は体制の相違（設計方針の相違）
 青字：記載箇所又は記載内容の相違（記載方針の相違）
 緑字：記載表現、設備名称の相違（実質的な相違なし）

大阪発電所3/4号炉						女川原子力発電所2号炉						泊発電所3号炉						相違理由													
添付資料 1.3-3						添付資料9						添付資料9						【大阪】 記載表現の相違 ・女川審査実績の反映により表の名称が異なる。 ・また、表中の記載表現も一部異なるが、「号炉」以外の記載情報量に差異はない。 【女川】 記載表現の相違 設備名称の相違													
溢水影響評価で止水を期待できる設備 表1 止水を期待できる設備						表1 溢水影響評価において止水を期待できる設備(1/5)						表1 溢水影響評価において止水を期待できる設備 (1/2)																			
号炉	設置場所	設置高さ	対象		新設 既設	箇所数	設置エリア	フロア	対象 (区画番号)	種類	区分	箇所数	設置エリア	フロア	対象 (区画番号)	種類	区分		箇所数												
3号炉	原子炉 周辺建屋 (管理区域)	E.L. + 3.5m	逆流 防止 弁	機器ドレン 逆止弁	既設	2	原子炉建屋 原子炉棟	B3F	RCTC タービンポンプ室 (R-B3F-2)	水密扉	既設 (改造)	1	原子炉建屋	T.P. 2.3m	3V-W-500 (3-T/D AFWPT 排気管温水ビット行きドレン管逆止弁) (-)	逆止弁	新設	1													
				逆止弁	新設	10			FPMW ポンプ室 (R-B3F-8)	水密扉	新設	1				3V-W-501 (3-T/D AFWPT リーク管温水ビット行きドレン管逆止弁) (-)	逆止弁	新設	1												
				ペント逆止弁	新設	1				逆流防止 フジ絲	新設	5					3V-W-502 (3-R/B 非管理区域ドレン管定流ビット行きドレン管逆止弁) (-)	逆止弁	新設	1											
			目皿逆止弁	新設	11	RHR ポンプ(C)室 (R-B3F-7)			水密扉		既設 (改造)	1				3V-W-503 (3-主蒸気管室ドレン管定流ビット行きドレン管逆止弁) (-)		逆止弁	新設	1											
			サンブタンク*	既設	1				RHR ポンプ(B)室 (R-B3F-6)	水密扉	既設	1					T.P. 4.35m	水密扉 No. 69 (3RB-K-N4)	水密扉	新設	1										
			E.L. + 10.0m	逆流 防止 弁	機器ドレン 逆止弁	既設				3	HPCS ポンプ室 (R-B3F-5)	水密扉				既設			1	T.P. 10.3m	水密扉 No. 93 (3RB-H-N1)	水密扉	新設	1							
		目皿逆止弁			新設	9			LPCS ポンプ室 (R-B3F-4)	水密扉		既設			1	水密扉 No. 154 (3RB-H-N1)	水密扉	新設	1												
		水密扉			新設	14				RHR ポンプ(A)室 (R-B3F-3)	水密扉	既設			1		止水板 No. A (3RB-H-N5)	止水板	新設	1											
		E.L. + 17.1m	堰	新設	1	T.P. 17.8m			水密扉 No. 140 (3RB-F-N2)		水密扉	新設			1	止水板 DG-A (3RB-H-N1)		止水板	新設	1											
										E.L. + 26.0m	堰	新設			2		共通エリア・ハッチ (HR-207) (R-B2F-1)	堰	新設	1	DG-A 出入り口堰 (3DG-H-N2)	堰	既設	1							
						E.L. + 3.5m			逆流 防止 弁							機器ドレン 逆止弁						既設	2	MUWC ポンプ室 (R-B2F-5)	堰	新設	1	DG-B 出入り口堰 (3DG-H-N1)	堰	既設	1
		目皿逆止弁	新設	11	RCTC MCC室 (R-B1F-4)					堰	新設	1			水密扉 No. 155 (3RB-F-N2)	水密扉	新設	1													
4号炉	原子炉 周辺建屋 (管理区域)	E.L. + 10.0m	水密扉	新設		1	B2F	共通エリア・ハッチ (HR-307) (R-B1F-1)	堰				新設	1		T.P. 24.8m	水密扉 No. 156 (3RB-D-N3)	水密扉	新設	1											
					E.L. + 17.1m					堰	新設	1			MS トンネル室 (R-B1F-3-2)			堰	新設	1	T.P. 29.4m	水密扉 No. 157 (3RB-D-N3)	水密扉	新設	1						
																							E.L. + 22.0m	堰	新設	1	R-02)北東階段室	堰	新設	1	T.P. 29.9m
		E.L. + 26.0m	堰	新設		2																									
					RHR 熱交換器室(A)室 (R-1F-1)					水密扉	新設	1			33.1m (区画境界②) 堰 (-)			堰	既設	1											
		FPC ポンプ室 (R-1F-3)	堰	新設		1															33.1m (区画境界③) 堰 (-)	堰	既設	1							
R-01)北西階段室	堰				新設		1	33.1m (区画境界④) 堰 (-)	堰	既設	1																				
		R-01)北西階段室	堰	新設		1						水密扉 No. 147 (3RB-H-1)	水密扉	新設	1																

※サンブタンクについては、水頭圧にて強度評価を実施した。

赤字：設備、運用又は体制の相違（設計方針の相違）
 青字：記載箇所又は記載内容の相違（記載方針の相違）
 緑字：記載表現、設備名称の相違（実質的な相違なし）

大阪発電所3/4号炉	女川原子力発電所2号炉	泊発電所3号炉	相違理由																																																																																																																																																																																																					
	<p>表1 溢水影響評価において止水を期待できる設備(2/5)</p> <table border="1"> <thead> <tr> <th>設置エリア</th> <th>フロア</th> <th>対象 (区画番号)</th> <th>種類</th> <th>区分</th> <th>箇所数</th> </tr> </thead> <tbody> <tr> <td rowspan="20">原子炉建屋 原子炉棟</td> <td rowspan="10">1F</td> <td>(R-02)北東階段室</td> <td>堰</td> <td>新設</td> <td>1</td> </tr> <tr> <td>バルブ室(A) (R-1F-9)</td> <td>堰</td> <td>新設</td> <td>1</td> </tr> <tr> <td>バルブ室(B) (R-1F-8)</td> <td>堰</td> <td>新設</td> <td>1</td> </tr> <tr> <td>R/B大物搬入用小扉</td> <td>水密扉</td> <td>新設</td> <td>1</td> </tr> <tr> <td>T/B連絡通路(東側)</td> <td>水密扉</td> <td>新設</td> <td>1</td> </tr> <tr> <td>T/B連絡通路(西側)</td> <td>水密扉</td> <td>新設</td> <td>1</td> </tr> <tr> <td>R/B大物搬入用扉</td> <td>水密扉</td> <td>新設</td> <td>1</td> </tr> <tr> <td rowspan="10">2F</td> <td>SGTSヒータユニット(A)室 (R-2F-1-2)</td> <td>水密扉</td> <td>新設</td> <td>1</td> </tr> <tr> <td>(R-01)北西階段室</td> <td>堰</td> <td>新設</td> <td>1</td> </tr> <tr> <td>CAMSラック(A)室 (R-2F-2-5)</td> <td>堰</td> <td>新設</td> <td>1</td> </tr> <tr> <td>CAMSラック(B)室 (R-2F-2-6)</td> <td>堰</td> <td>新設</td> <td>1</td> </tr> <tr> <td>SGTSヒータユニット(A)室 (R-2F-1-2)</td> <td>堰</td> <td>新設</td> <td>1</td> </tr> <tr> <td>SGTSヒータユニット(B)室 (R-2F-1-3)</td> <td>堰</td> <td>新設</td> <td>1</td> </tr> <tr> <td>(R-02)北東階段室</td> <td>堰</td> <td>新設</td> <td>1</td> </tr> <tr> <td>SGTSフィルタユニット室 (R-2F-1-1)</td> <td>堰</td> <td>新設</td> <td>1</td> </tr> <tr> <td>FCS再結合装置(A)室 (R-2F-2-2)</td> <td>堰</td> <td>新設</td> <td>1</td> </tr> <tr> <td>FCS再結合装置(B)室 (R-2F-2-3)</td> <td>堰</td> <td>新設</td> <td>1</td> </tr> <tr> <td rowspan="3">原子炉建屋 付属棟</td> <td rowspan="3">B3F</td> <td>RCW熱交換器(A)(C)室 (R-B3F-11)</td> <td>水密扉</td> <td>既設 (改造)</td> <td>1</td> </tr> <tr> <td>RCW熱交換器(B)(D)室 (R-B3F-14)</td> <td>水密扉</td> <td>既設</td> <td>1</td> </tr> <tr> <td>HPCW熱交換器室 (R-B3F-13)</td> <td>水密扉</td> <td>既設 (改造)</td> <td>1</td> </tr> </tbody> </table>	設置エリア	フロア	対象 (区画番号)	種類	区分	箇所数	原子炉建屋 原子炉棟	1F	(R-02)北東階段室	堰	新設	1	バルブ室(A) (R-1F-9)	堰	新設	1	バルブ室(B) (R-1F-8)	堰	新設	1	R/B大物搬入用小扉	水密扉	新設	1	T/B連絡通路(東側)	水密扉	新設	1	T/B連絡通路(西側)	水密扉	新設	1	R/B大物搬入用扉	水密扉	新設	1	2F	SGTSヒータユニット(A)室 (R-2F-1-2)	水密扉	新設	1	(R-01)北西階段室	堰	新設	1	CAMSラック(A)室 (R-2F-2-5)	堰	新設	1	CAMSラック(B)室 (R-2F-2-6)	堰	新設	1	SGTSヒータユニット(A)室 (R-2F-1-2)	堰	新設	1	SGTSヒータユニット(B)室 (R-2F-1-3)	堰	新設	1	(R-02)北東階段室	堰	新設	1	SGTSフィルタユニット室 (R-2F-1-1)	堰	新設	1	FCS再結合装置(A)室 (R-2F-2-2)	堰	新設	1	FCS再結合装置(B)室 (R-2F-2-3)	堰	新設	1	原子炉建屋 付属棟	B3F	RCW熱交換器(A)(C)室 (R-B3F-11)	水密扉	既設 (改造)	1	RCW熱交換器(B)(D)室 (R-B3F-14)	水密扉	既設	1	HPCW熱交換器室 (R-B3F-13)	水密扉	既設 (改造)	1	<p>表1 溢水影響評価において止水を期待できる設備(2/2)</p> <table border="1"> <thead> <tr> <th>設置エリア</th> <th>フロア</th> <th>対象(区画番号)</th> <th>種類</th> <th>区分</th> <th>箇所数</th> </tr> </thead> <tbody> <tr> <td rowspan="20">原子炉補助 建屋</td> <td rowspan="2">T.P.-3.7m</td> <td>湧水ビット開口部ハッチ(3AB-L-N1)</td> <td>ハッチ</td> <td>新設</td> <td>1</td> </tr> <tr> <td>3V-FD-106(3-湧水ビットポンプ室フロアドレン目皿(SA-001)逆止弁) (3AB-L-N1)</td> <td>逆止弁</td> <td>新設</td> <td>1</td> </tr> <tr> <td rowspan="2">T.P.2.8m</td> <td>水密扉No.68(-)</td> <td>水密扉</td> <td>新設</td> <td>1</td> </tr> <tr> <td>止水板2.8-A(-)</td> <td>止水板</td> <td>新設</td> <td>1</td> </tr> <tr> <td rowspan="2">T.P.6.3m</td> <td>水密扉No.73(3AB-K-4)</td> <td>水密扉</td> <td>新設</td> <td>1</td> </tr> <tr> <td>水密扉No.77(3AB-H-1)</td> <td>水密扉</td> <td>新設</td> <td>1</td> </tr> <tr> <td rowspan="10">T.P.10.3m</td> <td>水密扉No.78(3AB-H-S4)</td> <td>水密扉</td> <td>新設</td> <td>1</td> </tr> <tr> <td>水密扉No.87(-)</td> <td>水密扉</td> <td>新設</td> <td>1</td> </tr> <tr> <td>水密扉No.85(3AB-H-N2)</td> <td>水密扉</td> <td>新設</td> <td>1</td> </tr> <tr> <td>管理区域出入り口堰(-)</td> <td>堰</td> <td>既設</td> <td>1</td> </tr> <tr> <td>10.3m(A-D階段前機器ハッチ廻り)堰 (3AB-K-4)</td> <td>堰</td> <td>既設</td> <td>1</td> </tr> <tr> <td>止水板No.80(3AB-H-M6)</td> <td>止水板</td> <td>新設</td> <td>1</td> </tr> <tr> <td>止水板No.81(3AB-H-M6)</td> <td>止水板</td> <td>新設</td> <td>1</td> </tr> <tr> <td>止水板No.82(3AB-H-N1)</td> <td>止水板</td> <td>新設</td> <td>1</td> </tr> <tr> <td>水密扉No.141(3AB-F-N7)</td> <td>水密扉</td> <td>新設</td> <td>1</td> </tr> <tr> <td>水密扉No.142(-)</td> <td>水密扉</td> <td>新設</td> <td>1</td> </tr> <tr> <td rowspan="4">T.P.17.8m</td> <td>水密扉No.143(3AB-F-N7)</td> <td>水密扉</td> <td>新設</td> <td>1</td> </tr> <tr> <td>A-安全系計装盤室(西側)通路(仮称) (3AB-F-N13)</td> <td>止水板^①</td> <td>新設</td> <td>1</td> </tr> <tr> <td>A-安全系計装盤室(東側)通路(仮称) (3AB-F-N13)</td> <td>止水板^①</td> <td>新設</td> <td>1</td> </tr> <tr> <td>B-安全系計装盤室(西側)通路(仮称) (3AB-F-N2)</td> <td>止水板^①</td> <td>新設</td> <td>1</td> </tr> <tr> <td rowspan="3">T.P.21.2m</td> <td>B-安全系計装盤室(東側)通路(仮称) (3AB-F-N2)</td> <td>止水板^①</td> <td>新設</td> <td>1</td> </tr> <tr> <td>水密扉No.144(3AB-F-N7)</td> <td>水密扉</td> <td>新設</td> <td>1</td> </tr> <tr> <td>T.P.33.1m</td> <td>33.5m(区画境界)堰(-)</td> <td>堰</td> <td>既設</td> <td>1</td> </tr> </tbody> </table> <p>※1 現状の基本設計段階にて想定しているものであり、今後詳細設計等を精査するに伴い変更が生じる可能性がある。</p>	設置エリア	フロア	対象(区画番号)	種類	区分	箇所数	原子炉補助 建屋	T.P.-3.7m	湧水ビット開口部ハッチ(3AB-L-N1)	ハッチ	新設	1	3V-FD-106(3-湧水ビットポンプ室フロアドレン目皿(SA-001)逆止弁) (3AB-L-N1)	逆止弁	新設	1	T.P.2.8m	水密扉No.68(-)	水密扉	新設	1	止水板2.8-A(-)	止水板	新設	1	T.P.6.3m	水密扉No.73(3AB-K-4)	水密扉	新設	1	水密扉No.77(3AB-H-1)	水密扉	新設	1	T.P.10.3m	水密扉No.78(3AB-H-S4)	水密扉	新設	1	水密扉No.87(-)	水密扉	新設	1	水密扉No.85(3AB-H-N2)	水密扉	新設	1	管理区域出入り口堰(-)	堰	既設	1	10.3m(A-D階段前機器ハッチ廻り)堰 (3AB-K-4)	堰	既設	1	止水板No.80(3AB-H-M6)	止水板	新設	1	止水板No.81(3AB-H-M6)	止水板	新設	1	止水板No.82(3AB-H-N1)	止水板	新設	1	水密扉No.141(3AB-F-N7)	水密扉	新設	1	水密扉No.142(-)	水密扉	新設	1	T.P.17.8m	水密扉No.143(3AB-F-N7)	水密扉	新設	1	A-安全系計装盤室(西側)通路(仮称) (3AB-F-N13)	止水板 ^①	新設	1	A-安全系計装盤室(東側)通路(仮称) (3AB-F-N13)	止水板 ^①	新設	1	B-安全系計装盤室(西側)通路(仮称) (3AB-F-N2)	止水板 ^①	新設	1	T.P.21.2m	B-安全系計装盤室(東側)通路(仮称) (3AB-F-N2)	止水板 ^①	新設	1	水密扉No.144(3AB-F-N7)	水密扉	新設	1	T.P.33.1m	33.5m(区画境界)堰(-)	堰	既設	1	<p>【女川】</p> <p>設備名称の相違</p> <p>記載表現の相違</p>
設置エリア	フロア	対象 (区画番号)	種類	区分	箇所数																																																																																																																																																																																																			
原子炉建屋 原子炉棟	1F	(R-02)北東階段室	堰	新設	1																																																																																																																																																																																																			
		バルブ室(A) (R-1F-9)	堰	新設	1																																																																																																																																																																																																			
		バルブ室(B) (R-1F-8)	堰	新設	1																																																																																																																																																																																																			
		R/B大物搬入用小扉	水密扉	新設	1																																																																																																																																																																																																			
		T/B連絡通路(東側)	水密扉	新設	1																																																																																																																																																																																																			
		T/B連絡通路(西側)	水密扉	新設	1																																																																																																																																																																																																			
		R/B大物搬入用扉	水密扉	新設	1																																																																																																																																																																																																			
		2F	SGTSヒータユニット(A)室 (R-2F-1-2)	水密扉	新設	1																																																																																																																																																																																																		
			(R-01)北西階段室	堰	新設	1																																																																																																																																																																																																		
			CAMSラック(A)室 (R-2F-2-5)	堰	新設	1																																																																																																																																																																																																		
	CAMSラック(B)室 (R-2F-2-6)		堰	新設	1																																																																																																																																																																																																			
	SGTSヒータユニット(A)室 (R-2F-1-2)		堰	新設	1																																																																																																																																																																																																			
	SGTSヒータユニット(B)室 (R-2F-1-3)		堰	新設	1																																																																																																																																																																																																			
	(R-02)北東階段室		堰	新設	1																																																																																																																																																																																																			
	SGTSフィルタユニット室 (R-2F-1-1)		堰	新設	1																																																																																																																																																																																																			
	FCS再結合装置(A)室 (R-2F-2-2)		堰	新設	1																																																																																																																																																																																																			
	FCS再結合装置(B)室 (R-2F-2-3)		堰	新設	1																																																																																																																																																																																																			
	原子炉建屋 付属棟	B3F	RCW熱交換器(A)(C)室 (R-B3F-11)	水密扉	既設 (改造)	1																																																																																																																																																																																																		
			RCW熱交換器(B)(D)室 (R-B3F-14)	水密扉	既設	1																																																																																																																																																																																																		
			HPCW熱交換器室 (R-B3F-13)	水密扉	既設 (改造)	1																																																																																																																																																																																																		
設置エリア	フロア	対象(区画番号)	種類	区分	箇所数																																																																																																																																																																																																			
原子炉補助 建屋	T.P.-3.7m	湧水ビット開口部ハッチ(3AB-L-N1)	ハッチ	新設	1																																																																																																																																																																																																			
		3V-FD-106(3-湧水ビットポンプ室フロアドレン目皿(SA-001)逆止弁) (3AB-L-N1)	逆止弁	新設	1																																																																																																																																																																																																			
	T.P.2.8m	水密扉No.68(-)	水密扉	新設	1																																																																																																																																																																																																			
		止水板2.8-A(-)	止水板	新設	1																																																																																																																																																																																																			
	T.P.6.3m	水密扉No.73(3AB-K-4)	水密扉	新設	1																																																																																																																																																																																																			
		水密扉No.77(3AB-H-1)	水密扉	新設	1																																																																																																																																																																																																			
	T.P.10.3m	水密扉No.78(3AB-H-S4)	水密扉	新設	1																																																																																																																																																																																																			
		水密扉No.87(-)	水密扉	新設	1																																																																																																																																																																																																			
		水密扉No.85(3AB-H-N2)	水密扉	新設	1																																																																																																																																																																																																			
		管理区域出入り口堰(-)	堰	既設	1																																																																																																																																																																																																			
		10.3m(A-D階段前機器ハッチ廻り)堰 (3AB-K-4)	堰	既設	1																																																																																																																																																																																																			
		止水板No.80(3AB-H-M6)	止水板	新設	1																																																																																																																																																																																																			
		止水板No.81(3AB-H-M6)	止水板	新設	1																																																																																																																																																																																																			
		止水板No.82(3AB-H-N1)	止水板	新設	1																																																																																																																																																																																																			
		水密扉No.141(3AB-F-N7)	水密扉	新設	1																																																																																																																																																																																																			
		水密扉No.142(-)	水密扉	新設	1																																																																																																																																																																																																			
	T.P.17.8m	水密扉No.143(3AB-F-N7)	水密扉	新設	1																																																																																																																																																																																																			
		A-安全系計装盤室(西側)通路(仮称) (3AB-F-N13)	止水板 ^①	新設	1																																																																																																																																																																																																			
		A-安全系計装盤室(東側)通路(仮称) (3AB-F-N13)	止水板 ^①	新設	1																																																																																																																																																																																																			
		B-安全系計装盤室(西側)通路(仮称) (3AB-F-N2)	止水板 ^①	新設	1																																																																																																																																																																																																			
T.P.21.2m	B-安全系計装盤室(東側)通路(仮称) (3AB-F-N2)	止水板 ^①	新設	1																																																																																																																																																																																																				
	水密扉No.144(3AB-F-N7)	水密扉	新設	1																																																																																																																																																																																																				
	T.P.33.1m	33.5m(区画境界)堰(-)	堰	既設	1																																																																																																																																																																																																			

赤字：設備、運用又は体制の相違（設計方針の相違）
 青字：記載箇所又は記載内容の相違（記載方針の相違）
 緑字：記載表現、設備名称の相違（実質的な相違なし）

大阪発電所3/4号炉	女川原子力発電所2号炉						泊発電所3号炉	相違理由																																																																																									
表1 溢水影響評価において止水を期待できる設備(3/5)																																																																																																	
<table border="1"> <thead> <tr> <th data-bbox="703 218 792 253">設置エリア</th> <th data-bbox="799 218 853 253">フロア</th> <th data-bbox="860 218 1070 253">対象 (区画番号)</th> <th data-bbox="1077 218 1131 253">種類</th> <th data-bbox="1137 218 1191 253">区分</th> <th data-bbox="1198 218 1274 253">箇所数</th> </tr> </thead> <tbody> <tr> <td data-bbox="703 258 792 810" rowspan="16">原子力建屋 付属棟</td> <td data-bbox="799 258 853 336" rowspan="2">R2F</td> <td data-bbox="860 258 1070 293">静止型PLRポンプ電源装置室 (R-R2F-8)</td> <td data-bbox="1077 258 1131 293">堰</td> <td data-bbox="1137 258 1191 293">新設</td> <td data-bbox="1198 258 1274 293">1</td> </tr> <tr> <td data-bbox="860 298 1070 336">IA, SA室及び通路 (R-R2F-9)</td> <td data-bbox="1077 298 1131 336">堰</td> <td data-bbox="1137 298 1191 336">新設</td> <td data-bbox="1198 298 1274 336">1</td> </tr> <tr> <td data-bbox="799 341 853 419" rowspan="3">B1F</td> <td data-bbox="860 341 1070 376">区分II非常用電気品室 (R-B1F-10)</td> <td data-bbox="1077 341 1131 376">水密扉</td> <td data-bbox="1137 341 1191 376">新設</td> <td data-bbox="1198 341 1274 376">1</td> </tr> <tr> <td data-bbox="860 381 1070 419">D/G補機(A)室 (R-B1F-7)</td> <td data-bbox="1077 381 1131 419">堰</td> <td data-bbox="1137 381 1191 419">新設</td> <td data-bbox="1198 381 1274 419">1</td> </tr> <tr> <td data-bbox="860 424 1070 462">区分IIIPCS電気品室 (R-B1F-9)</td> <td data-bbox="1077 424 1131 462">堰</td> <td data-bbox="1137 424 1191 462">新設</td> <td data-bbox="1198 424 1274 462">1</td> </tr> <tr> <td data-bbox="799 467 853 625" rowspan="4">1F</td> <td data-bbox="860 467 1070 505">D/G(II)PCS室 (R-1F-15)</td> <td data-bbox="1077 467 1131 505">水密扉</td> <td data-bbox="1137 467 1191 505">新設</td> <td data-bbox="1198 467 1274 505">1</td> </tr> <tr> <td data-bbox="860 510 1070 549">区分I非常用D/G制御室 (R-1F-13-1)</td> <td data-bbox="1077 510 1131 549">堰</td> <td data-bbox="1137 510 1191 549">新設</td> <td data-bbox="1198 510 1274 549">1</td> </tr> <tr> <td data-bbox="860 553 1070 592">区分III非常用D/G制御室 (R-1F-15-1)</td> <td data-bbox="1077 553 1131 592">堰</td> <td data-bbox="1137 553 1191 592">新設</td> <td data-bbox="1198 553 1274 592">1</td> </tr> <tr> <td data-bbox="860 596 1070 635">HWH熱交換器・ポンプ室 (R-1F-17)</td> <td data-bbox="1077 596 1131 635">水密扉</td> <td data-bbox="1137 596 1191 635">新設</td> <td data-bbox="1198 596 1274 635">1</td> </tr> <tr> <td data-bbox="799 630 853 810" rowspan="4">2F</td> <td data-bbox="860 630 1070 668">HECW冷凍機(B)(D)室 (R-2F-4)</td> <td data-bbox="1077 630 1131 668">水密扉</td> <td data-bbox="1137 630 1191 668">新設</td> <td data-bbox="1198 630 1274 668">1</td> </tr> <tr> <td data-bbox="860 673 1070 711">2F通路(O.P.23600) (R-2F-16-1)</td> <td data-bbox="1077 673 1131 711">水密扉</td> <td data-bbox="1137 673 1191 711">新設</td> <td data-bbox="1198 673 1274 711">1</td> </tr> <tr> <td data-bbox="860 716 1070 754">原子力補機(A)室送風機室 (R-2F-6)</td> <td data-bbox="1077 716 1131 754">堰</td> <td data-bbox="1137 716 1191 754">新設</td> <td data-bbox="1198 716 1274 754">1</td> </tr> <tr> <td data-bbox="860 759 1070 798">原子力補機(B)室 送風機室及び送風機エリア (R-2F-8)</td> <td data-bbox="1077 759 1131 798">堰</td> <td data-bbox="1137 759 1191 798">新設</td> <td data-bbox="1198 759 1274 798">2</td> </tr> <tr> <td data-bbox="703 815 792 1018" rowspan="6">原子力建屋 付属棟 (廃棄物処 理エリア)</td> <td data-bbox="799 815 853 834">R3F</td> <td data-bbox="860 815 1070 834">2T-1トレンチ</td> <td data-bbox="1077 815 1131 834">水密扉</td> <td data-bbox="1137 815 1191 834">新設</td> <td data-bbox="1198 815 1274 834">1</td> </tr> <tr> <td data-bbox="799 839 853 1018" rowspan="5">1F</td> <td data-bbox="860 839 1070 861">主排気ダクト連絡トレンチ</td> <td data-bbox="1077 839 1131 861">水密扉</td> <td data-bbox="1137 839 1191 861">新設</td> <td data-bbox="1198 839 1274 861">1</td> </tr> <tr> <td data-bbox="860 866 1070 888">1F共通エリア(大物搬入用扉)</td> <td data-bbox="1077 866 1131 888">水密扉</td> <td data-bbox="1137 866 1191 888">新設</td> <td data-bbox="1198 866 1274 888">1</td> </tr> <tr> <td data-bbox="860 893 1070 916">1F共通エリア (Rw-1F-1)</td> <td data-bbox="1077 893 1131 916">水密扉</td> <td data-bbox="1137 893 1191 916">新設</td> <td data-bbox="1198 893 1274 916">1</td> </tr> <tr> <td data-bbox="860 920 1070 943">Rw制御室扉</td> <td data-bbox="1077 920 1131 943">水密扉</td> <td data-bbox="1137 920 1191 943">新設</td> <td data-bbox="1198 920 1274 943">1</td> </tr> <tr> <td data-bbox="860 948 1070 970">Rw制御室送風機室 (Rw-1F-2-4)</td> <td data-bbox="1077 948 1131 970">水密扉</td> <td data-bbox="1137 948 1191 970">新設</td> <td data-bbox="1198 948 1274 970">1</td> </tr> </tbody> </table>								設置エリア	フロア	対象 (区画番号)	種類	区分	箇所数	原子力建屋 付属棟	R2F	静止型PLRポンプ電源装置室 (R-R2F-8)	堰	新設	1	IA, SA室及び通路 (R-R2F-9)	堰	新設	1	B1F	区分II非常用電気品室 (R-B1F-10)	水密扉	新設	1	D/G補機(A)室 (R-B1F-7)	堰	新設	1	区分IIIPCS電気品室 (R-B1F-9)	堰	新設	1	1F	D/G(II)PCS室 (R-1F-15)	水密扉	新設	1	区分I非常用D/G制御室 (R-1F-13-1)	堰	新設	1	区分III非常用D/G制御室 (R-1F-15-1)	堰	新設	1	HWH熱交換器・ポンプ室 (R-1F-17)	水密扉	新設	1	2F	HECW冷凍機(B)(D)室 (R-2F-4)	水密扉	新設	1	2F通路(O.P.23600) (R-2F-16-1)	水密扉	新設	1	原子力補機(A)室送風機室 (R-2F-6)	堰	新設	1	原子力補機(B)室 送風機室及び送風機エリア (R-2F-8)	堰	新設	2	原子力建屋 付属棟 (廃棄物処 理エリア)	R3F	2T-1トレンチ	水密扉	新設	1	1F	主排気ダクト連絡トレンチ	水密扉	新設	1	1F共通エリア(大物搬入用扉)	水密扉	新設	1	1F共通エリア (Rw-1F-1)	水密扉	新設	1	Rw制御室扉	水密扉	新設	1	Rw制御室送風機室 (Rw-1F-2-4)	水密扉	新設	1
設置エリア	フロア	対象 (区画番号)	種類	区分	箇所数																																																																																												
原子力建屋 付属棟	R2F	静止型PLRポンプ電源装置室 (R-R2F-8)	堰	新設	1																																																																																												
		IA, SA室及び通路 (R-R2F-9)	堰	新設	1																																																																																												
	B1F	区分II非常用電気品室 (R-B1F-10)	水密扉	新設	1																																																																																												
		D/G補機(A)室 (R-B1F-7)	堰	新設	1																																																																																												
		区分IIIPCS電気品室 (R-B1F-9)	堰	新設	1																																																																																												
	1F	D/G(II)PCS室 (R-1F-15)	水密扉	新設	1																																																																																												
		区分I非常用D/G制御室 (R-1F-13-1)	堰	新設	1																																																																																												
		区分III非常用D/G制御室 (R-1F-15-1)	堰	新設	1																																																																																												
		HWH熱交換器・ポンプ室 (R-1F-17)	水密扉	新設	1																																																																																												
	2F	HECW冷凍機(B)(D)室 (R-2F-4)	水密扉	新設	1																																																																																												
		2F通路(O.P.23600) (R-2F-16-1)	水密扉	新設	1																																																																																												
		原子力補機(A)室送風機室 (R-2F-6)	堰	新設	1																																																																																												
		原子力補機(B)室 送風機室及び送風機エリア (R-2F-8)	堰	新設	2																																																																																												
	原子力建屋 付属棟 (廃棄物処 理エリア)	R3F	2T-1トレンチ	水密扉	新設	1																																																																																											
		1F	主排気ダクト連絡トレンチ	水密扉	新設	1																																																																																											
			1F共通エリア(大物搬入用扉)	水密扉	新設	1																																																																																											
1F共通エリア (Rw-1F-1)			水密扉	新設	1																																																																																												
Rw制御室扉			水密扉	新設	1																																																																																												
Rw制御室送風機室 (Rw-1F-2-4)			水密扉	新設	1																																																																																												

赤字：設備、運用又は体制の相違（設計方針の相違）
 青字：記載箇所又は記載内容の相違（記載方針の相違）
 緑字：記載表現、設備名称の相違（実質的な相違なし）

大阪発電所3/4号炉	女川原子力発電所2号炉					泊発電所3号炉	相違理由																																																																																		
	表1 溢水影響評価において止水を期待できる設備(4/5)						【女川】 設備名称の相違 記載表現の相違																																																																																		
	<table border="1"> <thead> <tr> <th>設置エリア</th> <th>フロア</th> <th>対象 (区画番号)</th> <th>種類</th> <th>区分</th> <th>箇所数</th> </tr> </thead> <tbody> <tr> <td rowspan="18">制御建屋</td> <td rowspan="5">B2F</td> <td>制御建屋空調機械(B)室南側 (C-B2F-2)</td> <td>水密扉</td> <td>既設</td> <td>1</td> </tr> <tr> <td>制御建屋空調機械(B)室北側 (C-B2F-2)</td> <td>水密扉</td> <td>既設</td> <td>1</td> </tr> <tr> <td>制御建屋空調機械(B)室 【250V 直流主母線盤室境界】 (C-B2F-2)</td> <td>水密扉</td> <td>既設 (改造)</td> <td>1</td> </tr> <tr> <td>T/B 連絡通路扉</td> <td>水密扉</td> <td>新設</td> <td>1</td> </tr> <tr> <td>1号C/B 連絡通路</td> <td>水密扉</td> <td>新設</td> <td>1</td> </tr> <tr> <td>1S1 室 (C-B2F-5)</td> <td>水密扉</td> <td>新設</td> <td>1</td> </tr> <tr> <td rowspan="4">B1F</td> <td>計測制御電源室(A) 【計測制御電源室(B)境界】 (C-B1F-3)</td> <td>水密扉</td> <td>新設</td> <td>1</td> </tr> <tr> <td>計測制御電源室(A) 【常用及び共通M/C、P/C室境界】 (C-B1F-3)</td> <td>水密扉</td> <td>新設</td> <td>1</td> </tr> <tr> <td>常用及び共通M/C、P/C室 【BSS 盤室境界】 (C-B1F-1)</td> <td>水密扉</td> <td>新設</td> <td>1</td> </tr> <tr> <td>計測制御電源室(B) (C-B1F-5)</td> <td>水密扉</td> <td>新設</td> <td>1</td> </tr> <tr> <td rowspan="5">1F</td> <td>T/B 連絡通路扉</td> <td>水密扉</td> <td>新設</td> <td>1</td> </tr> <tr> <td>1F 入退域エリア (管理区域) (C-1F-1)</td> <td>水密扉</td> <td>新設</td> <td>1</td> </tr> <tr> <td>1F 入退域エリア (管理区域へ ヘルメット置場) (C-1F-1)</td> <td>水密扉</td> <td>新設</td> <td>1</td> </tr> <tr> <td>1号C/B 連絡通路</td> <td>水密扉</td> <td>新設</td> <td>2</td> </tr> <tr> <td>補助ボイラー建屋連絡通路</td> <td>水密扉</td> <td>新設</td> <td>1</td> </tr> <tr> <td rowspan="2">2F</td> <td>1号C/B 連絡通路</td> <td>水密扉</td> <td>新設</td> <td>1</td> </tr> <tr> <td>区分-1 ケーブル処理室 (C-2F-1)</td> <td>扉</td> <td>新設</td> <td>1</td> </tr> <tr> <td rowspan="2">3F</td> <td>常用系ケーブル処理室 (C-2F-4)</td> <td>扉</td> <td>新設</td> <td>2</td> </tr> <tr> <td>1号MCR 境界</td> <td>水密扉</td> <td>新設</td> <td>1</td> </tr> </tbody> </table>	設置エリア	フロア	対象 (区画番号)	種類	区分		箇所数	制御建屋	B2F	制御建屋空調機械(B)室南側 (C-B2F-2)	水密扉	既設	1	制御建屋空調機械(B)室北側 (C-B2F-2)	水密扉	既設	1	制御建屋空調機械(B)室 【250V 直流主母線盤室境界】 (C-B2F-2)	水密扉	既設 (改造)	1	T/B 連絡通路扉	水密扉	新設	1	1号C/B 連絡通路	水密扉	新設	1	1S1 室 (C-B2F-5)	水密扉	新設	1	B1F	計測制御電源室(A) 【計測制御電源室(B)境界】 (C-B1F-3)	水密扉	新設	1	計測制御電源室(A) 【常用及び共通M/C、P/C室境界】 (C-B1F-3)	水密扉	新設	1	常用及び共通M/C、P/C室 【BSS 盤室境界】 (C-B1F-1)	水密扉	新設	1	計測制御電源室(B) (C-B1F-5)	水密扉	新設	1	1F	T/B 連絡通路扉	水密扉	新設	1	1F 入退域エリア (管理区域) (C-1F-1)	水密扉	新設	1	1F 入退域エリア (管理区域へ ヘルメット置場) (C-1F-1)	水密扉	新設	1	1号C/B 連絡通路	水密扉	新設	2	補助ボイラー建屋連絡通路	水密扉	新設	1	2F	1号C/B 連絡通路	水密扉	新設	1	区分-1 ケーブル処理室 (C-2F-1)	扉	新設	1	3F	常用系ケーブル処理室 (C-2F-4)	扉	新設	2	1号MCR 境界	水密扉	新設
設置エリア	フロア	対象 (区画番号)	種類	区分	箇所数																																																																																				
制御建屋	B2F	制御建屋空調機械(B)室南側 (C-B2F-2)	水密扉	既設	1																																																																																				
		制御建屋空調機械(B)室北側 (C-B2F-2)	水密扉	既設	1																																																																																				
		制御建屋空調機械(B)室 【250V 直流主母線盤室境界】 (C-B2F-2)	水密扉	既設 (改造)	1																																																																																				
		T/B 連絡通路扉	水密扉	新設	1																																																																																				
		1号C/B 連絡通路	水密扉	新設	1																																																																																				
	1S1 室 (C-B2F-5)	水密扉	新設	1																																																																																					
	B1F	計測制御電源室(A) 【計測制御電源室(B)境界】 (C-B1F-3)	水密扉	新設	1																																																																																				
		計測制御電源室(A) 【常用及び共通M/C、P/C室境界】 (C-B1F-3)	水密扉	新設	1																																																																																				
		常用及び共通M/C、P/C室 【BSS 盤室境界】 (C-B1F-1)	水密扉	新設	1																																																																																				
		計測制御電源室(B) (C-B1F-5)	水密扉	新設	1																																																																																				
	1F	T/B 連絡通路扉	水密扉	新設	1																																																																																				
		1F 入退域エリア (管理区域) (C-1F-1)	水密扉	新設	1																																																																																				
		1F 入退域エリア (管理区域へ ヘルメット置場) (C-1F-1)	水密扉	新設	1																																																																																				
		1号C/B 連絡通路	水密扉	新設	2																																																																																				
		補助ボイラー建屋連絡通路	水密扉	新設	1																																																																																				
	2F	1号C/B 連絡通路	水密扉	新設	1																																																																																				
		区分-1 ケーブル処理室 (C-2F-1)	扉	新設	1																																																																																				
	3F	常用系ケーブル処理室 (C-2F-4)	扉	新設	2																																																																																				
1号MCR 境界		水密扉	新設	1																																																																																					

赤字：設備、運用又は体制の相違（設計方針の相違）
 青字：記載箇所又は記載内容の相違（記載方針の相違）
 緑字：記載表現、設備名称の相違（実質的な相違なし）



大阪発電所3/4号炉	女川原子力発電所2号炉	泊発電所3号炉	相違理由																																																																									
	<p>表1 溢水影響評価において止水を期待できる設備(5/5)</p> <table border="1"> <thead> <tr> <th>設置エリア</th> <th>フロア</th> <th>対象 (区画番号)</th> <th>種類</th> <th>区分</th> <th>箇所数</th> </tr> </thead> <tbody> <tr> <td rowspan="5">タービン 建屋</td> <td>B2F</td> <td>B2F エリア (T-B2F-1)</td> <td>止水壁</td> <td>既設 (改造)</td> <td>1</td> </tr> <tr> <td>B1F</td> <td>B1F エリア (T-B1F-1)</td> <td>堰</td> <td>新設</td> <td>1</td> </tr> <tr> <td rowspan="3">1F</td> <td>大物搬入用扉</td> <td>堰</td> <td>新設</td> <td>1</td> </tr> <tr> <td>大物搬入用横扉</td> <td>堰</td> <td>新設</td> <td>1</td> </tr> <tr> <td>共通エリア【東側】(No.1)</td> <td>堰</td> <td>新設</td> <td>1</td> </tr> <tr> <td></td> <td></td> <td>共通エリア【東側】(No.2)</td> <td>堰</td> <td>新設</td> <td>1</td> </tr> <tr> <td rowspan="3">海水ポンプ 室</td> <td>—</td> <td>RSW ポンプ(A)(C)室 (SW-1F-2)</td> <td>水密扉</td> <td>既設 (改造)</td> <td>1</td> </tr> <tr> <td>—</td> <td>RSW ポンプ(B)(D)室 (SW-1F-5)</td> <td>水密扉</td> <td>既設 (改造)</td> <td>1</td> </tr> <tr> <td>—</td> <td>HPSW ポンプ室 (SW-1F-4)</td> <td>水密扉</td> <td>既設 (改造)</td> <td>1</td> </tr> <tr> <td rowspan="4">軽油タンク エリア</td> <td>—</td> <td>燃料移送ポンプ(A)エリア (LOT-1)</td> <td>水密扉</td> <td>新設</td> <td>1</td> </tr> <tr> <td>—</td> <td>燃料移送ポンプ(B)エリア (LOT-2)</td> <td>水密扉</td> <td>新設</td> <td>1</td> </tr> <tr> <td>—</td> <td>燃料移送ポンプ室アクセス用 ハッチ</td> <td>ハッチ</td> <td>新設</td> <td>2</td> </tr> <tr> <td>—</td> <td>燃料移送ポンプ室機器搬出入 用ハッチ</td> <td>ハッチ</td> <td>新設</td> <td>1</td> </tr> </tbody> </table>	設置エリア	フロア	対象 (区画番号)	種類	区分	箇所数	タービン 建屋	B2F	B2F エリア (T-B2F-1)	止水壁	既設 (改造)	1	B1F	B1F エリア (T-B1F-1)	堰	新設	1	1F	大物搬入用扉	堰	新設	1	大物搬入用横扉	堰	新設	1	共通エリア【東側】(No.1)	堰	新設	1			共通エリア【東側】(No.2)	堰	新設	1	海水ポンプ 室	—	RSW ポンプ(A)(C)室 (SW-1F-2)	水密扉	既設 (改造)	1	—	RSW ポンプ(B)(D)室 (SW-1F-5)	水密扉	既設 (改造)	1	—	HPSW ポンプ室 (SW-1F-4)	水密扉	既設 (改造)	1	軽油タンク エリア	—	燃料移送ポンプ(A)エリア (LOT-1)	水密扉	新設	1	—	燃料移送ポンプ(B)エリア (LOT-2)	水密扉	新設	1	—	燃料移送ポンプ室アクセス用 ハッチ	ハッチ	新設	2	—	燃料移送ポンプ室機器搬出入 用ハッチ	ハッチ	新設	1		<p>【女川】 設備名称の相違 記載表現の相違</p>
設置エリア	フロア	対象 (区画番号)	種類	区分	箇所数																																																																							
タービン 建屋	B2F	B2F エリア (T-B2F-1)	止水壁	既設 (改造)	1																																																																							
	B1F	B1F エリア (T-B1F-1)	堰	新設	1																																																																							
	1F	大物搬入用扉	堰	新設	1																																																																							
		大物搬入用横扉	堰	新設	1																																																																							
		共通エリア【東側】(No.1)	堰	新設	1																																																																							
		共通エリア【東側】(No.2)	堰	新設	1																																																																							
海水ポンプ 室	—	RSW ポンプ(A)(C)室 (SW-1F-2)	水密扉	既設 (改造)	1																																																																							
	—	RSW ポンプ(B)(D)室 (SW-1F-5)	水密扉	既設 (改造)	1																																																																							
	—	HPSW ポンプ室 (SW-1F-4)	水密扉	既設 (改造)	1																																																																							
軽油タンク エリア	—	燃料移送ポンプ(A)エリア (LOT-1)	水密扉	新設	1																																																																							
	—	燃料移送ポンプ(B)エリア (LOT-2)	水密扉	新設	1																																																																							
	—	燃料移送ポンプ室アクセス用 ハッチ	ハッチ	新設	2																																																																							
	—	燃料移送ポンプ室機器搬出入 用ハッチ	ハッチ	新設	1																																																																							
<p>【参考】伊方発電所3号炉</p> <p>添付資料1-3 水密区画について</p> <p>1. 概要</p> <p>水密区画は、耐水性のある塗装を施した壁、堰で囲まれた区画となっており、区画内のタンクおよび付属配管からの漏水を全量区画内にとどめることが可能な設計となっている。</p> <p>また、水密区画を構成する壁については、耐震壁または学協会規格・基準の要件を満たす鉄筋コンクリート造の壁であり、地震時においても健全性は維持できる。</p> <p>2. 水密区画内設置として溢水源から除外した機器</p> <p>伊方3号機における溢水源となりうる機器より、水密区画内設置として溢水源から対象外とした機器の一覧を表-1に示す。</p>		<p>水密区画について</p> <p>別紙1</p> <p>1. 概要</p> <p>水密区画は、耐水性のある塗装を施した壁、堰で囲まれた区画となっており、区画内のタンク及び付属配管からの漏水を全量区画内にとどめることが可能な設計となっている。</p> <p>また、水密区画を構成する壁については、耐震壁又は「鉄筋コンクリート構造計算規準・同解説（日本建築学会）」の規準上の耐震壁と同等な壁であり、地震時においても健全性は維持できる。</p> <p>2. 水密区画内設置として溢水源から除外した機器</p> <p>泊発電所3号炉における溢水源となりうる機器より、水密区画内設置として溢水源から対象外とした機器の一覧を表1に示す。</p>	<p>【女川】 設計方針の相違</p> <p>泊は閉鎖区画内に設置されたタンク類が多数あり、これらの区画境界の止水性を確保することで水密区画としている。水密区画内のタンク類から生じた溢水は区画内に留まるため、溢水源として想定しないことを明記している。本資料にて水密区画である水密コンパートメントの詳細を記載した。記載に際し、先行審査実績のある伊方3号炉を掲載する。 （泊欄の赤色は女川との相違を示しており、以下同様である。）</p> <p>【伊方】 記載表現の相違</p>																																																																									

赤字：設備、運用又は体制の相違（設計方針の相違）
 青字：記載箇所又は記載内容の相違（記載方針の相違）
 緑字：記載表現、設備名称の相違（実質的な相違なし）

第9条 溢水による損傷の防止等（別添1添付資料9）

大阪発電所3/4号炉	女川原子力発電所2号炉	泊発電所3号炉	相違理由																																																																																																																																																																
<p>【参考】伊方発電所3号炉</p> <p>表-1 伊方3号機における水密区画内設置機器一覧</p> <table border="1"> <thead> <tr> <th>水密区画内設置機器</th> <th>設置位置</th> <th>炉内容量</th> <th>電源種</th> <th>溢水高さ</th> <th>耐水塗膜高さ</th> <th>室入口高さ</th> <th>区画壁</th> </tr> </thead> <tbody> <tr> <td>冷却材貯蔵炉A</td> <td>A/B EL. 3. 3m</td> <td>204基</td> <td>150</td> <td>3. 06^①</td> <td>3. 7</td> <td>3. 7</td> <td>耐震壁 (①)</td> </tr> <tr> <td>冷却材貯蔵炉B</td> <td>A/B EL. 3. 3m</td> <td></td> <td></td> <td></td> <td></td> <td></td> <td></td> </tr> <tr> <td>使用済軽核貯蔵炉A</td> <td>A/B EL. 3. 3m</td> <td>77</td> <td>35</td> <td>2. 2</td> <td>2. 4</td> <td>8. 45</td> <td>耐震壁 (①)</td> </tr> <tr> <td>使用済軽核貯蔵炉B</td> <td>A/B EL. 3. 3m</td> <td>77</td> <td>35</td> <td>2. 2</td> <td>2. 4</td> <td>8. 45</td> <td>耐震壁 (①)</td> </tr> <tr> <td>使用済重油炉</td> <td>A/B EL. 3. 3m</td> <td>5. 3</td> <td>16</td> <td>0. 4</td> <td>2. 1</td> <td>3. 3</td> <td>耐震壁 (①、②)</td> </tr> <tr> <td>原液貯蔵炉A</td> <td>A/B EL. 3. 3m</td> <td>60</td> <td>65</td> <td>1. 0</td> <td>2. 1</td> <td>1. 6</td> <td>耐震壁 (①)</td> </tr> <tr> <td>原液貯蔵炉B</td> <td>A/B EL. 3. 3m</td> <td>60</td> <td>65</td> <td>1. 0</td> <td>2. 1</td> <td>1. 6</td> <td>耐震壁 (①)</td> </tr> <tr> <td>一次系純水炉</td> <td>B/F EL. 10. 0m</td> <td>510</td> <td>170</td> <td>3. 0</td> <td>4. 0</td> <td>7. 1</td> <td>耐震壁 (①)</td> </tr> <tr> <td>濃縮液投入炉A</td> <td>A/F EL. 10. 0m</td> <td>38</td> <td>32</td> <td>1. 2</td> <td>2. 1</td> <td>3. 6</td> <td>耐震壁 (①、②)</td> </tr> <tr> <td>濃縮液投入炉B</td> <td>A/F EL. 10. 0m</td> <td>38</td> <td>32</td> <td>1. 2</td> <td>2. 1</td> <td>3. 6</td> <td>耐震壁 (①、②)</td> </tr> <tr> <td>予備濃縮液炉</td> <td>A/B EL. 10. 0m</td> <td>12</td> <td>10</td> <td>0. 8</td> <td>2. 1</td> <td>1. 4</td> <td>耐震壁 (①、②)</td> </tr> <tr> <td>洗浄排水濃縮液投入炉</td> <td>A/B EL. 10. 0m</td> <td>12</td> <td>11</td> <td>1. 1</td> <td>2. 1</td> <td>1. 4</td> <td>耐震壁 (①、②)</td> </tr> </tbody> </table> <p>①：冷却材貯蔵タンクは2基で400%（304m³）以上の受入余裕を確保するよう、マニュアルで規定されているが、溢水高さの算出においては90%容量（受入率インターロック閉止水位）×2基の水量（548m³）を適用した。（冷却材貯蔵タンク等A、B型は普通定で適用）</p> <p>②：区画壁は、「①耐震設計上考慮している耐震壁」、耐震設計上考慮していないが「②協会規格・基準の要件を満たす耐震壁」に分類する。なお、「②協会規格・基準の要件を満たす耐震壁」は、原子力施設鉄筋コンクリート構造計算規程・同解説（日本建築学会、2005年）「19条 耐震壁の断面算定」第5項の記載（壁板の厚さ、壁板のせん断補強筋比、壁板の縦筋配置、壁板の径と間隔等）を満たす壁とする。</p> <p>3. 水密区画の構造</p> <p>水密区画は下記に示す設計としており、溢水した保有水が区画外へ漏えいしない構造となっている。図-1に水密区画の概要図を示す。</p> <p>①区画壁は鉄筋コンクリート造の壁であり地震時に倒壊、損傷しない強度を有するとともに、耐水性のあるエポキシ樹脂系塗料にて塗装が施されている</p> <p>②区画入口は溢水高さ以上に設置されている。</p> <p>③溢水高さ以下の壁貫通部は、シール施工をしており、外部へ漏洩しない設計としている。また貫通配管は貫通部前後でサポート固定されており、貫通部シールに大きな荷重がかからないよう配慮されている。</p> <p>④床ドレンラインの隔離弁は通常施錠閉としており、漏洩検知設備を設置。</p>	水密区画内設置機器	設置位置	炉内容量	電源種	溢水高さ	耐水塗膜高さ	室入口高さ	区画壁	冷却材貯蔵炉A	A/B EL. 3. 3m	204基	150	3. 06 ^①	3. 7	3. 7	耐震壁 (①)	冷却材貯蔵炉B	A/B EL. 3. 3m							使用済軽核貯蔵炉A	A/B EL. 3. 3m	77	35	2. 2	2. 4	8. 45	耐震壁 (①)	使用済軽核貯蔵炉B	A/B EL. 3. 3m	77	35	2. 2	2. 4	8. 45	耐震壁 (①)	使用済重油炉	A/B EL. 3. 3m	5. 3	16	0. 4	2. 1	3. 3	耐震壁 (①、②)	原液貯蔵炉A	A/B EL. 3. 3m	60	65	1. 0	2. 1	1. 6	耐震壁 (①)	原液貯蔵炉B	A/B EL. 3. 3m	60	65	1. 0	2. 1	1. 6	耐震壁 (①)	一次系純水炉	B/F EL. 10. 0m	510	170	3. 0	4. 0	7. 1	耐震壁 (①)	濃縮液投入炉A	A/F EL. 10. 0m	38	32	1. 2	2. 1	3. 6	耐震壁 (①、②)	濃縮液投入炉B	A/F EL. 10. 0m	38	32	1. 2	2. 1	3. 6	耐震壁 (①、②)	予備濃縮液炉	A/B EL. 10. 0m	12	10	0. 8	2. 1	1. 4	耐震壁 (①、②)	洗浄排水濃縮液投入炉	A/B EL. 10. 0m	12	11	1. 1	2. 1	1. 4	耐震壁 (①、②)	<p>表 1 泊発電所3号炉における水密区画内設置機器一覧</p> <table border="1"> <thead> <tr> <th>水密区画内設置機器</th> <th>設置場所</th> <th>タンク容量 (m³)</th> <th>室面積 (m²)</th> <th>溢水高さ (cm)</th> <th>耐水塗膜高さ (cm)</th> <th>室入口高さ (cm)</th> <th>区画壁</th> </tr> </thead> <tbody> <tr> <td>A-濃縮液貯蔵タンク</td> <td>原子炉</td> <td>25</td> <td rowspan="2">37.1</td> <td rowspan="2">134.8</td> <td rowspan="2">160</td> <td rowspan="2">280</td> <td rowspan="2">①、②</td> </tr> <tr> <td>B-濃縮液貯蔵タンク</td> <td>補助建屋 T.P. 17. 8m</td> <td>25</td> </tr> <tr> <td>A-冷却材貯蔵タンク</td> <td>原子炉 補助建屋 T.P. 2. 8m</td> <td>360</td> <td>64. 46</td> <td>558. 5</td> <td>561</td> <td>740</td> <td>①</td> </tr> <tr> <td>B-冷却材貯蔵タンク</td> <td>原子炉 補助建屋 T.P. 2. 8m</td> <td>360</td> <td>64. 46</td> <td>558. 5</td> <td>561</td> <td>740</td> <td>①</td> </tr> <tr> <td>A-使用済樹脂貯蔵タンク</td> <td>原子炉</td> <td>70</td> <td rowspan="3">72. 17</td> <td rowspan="3">291</td> <td rowspan="3">295</td> <td rowspan="3">810</td> <td rowspan="3">①</td> </tr> <tr> <td>B-使用済樹脂貯蔵タンク</td> <td>補助建屋 T.P. 2. 8m</td> <td>70</td> </tr> <tr> <td>C-使用済樹脂貯蔵タンク</td> <td></td> <td>70</td> </tr> <tr> <td>一次系純水タンク</td> <td>原子炉 建屋 T.P. 17. 8m</td> <td>365</td> <td>92. 48</td> <td>394. 7</td> <td>395</td> <td>690</td> <td>①</td> </tr> </tbody> </table> <p>※1 区画壁は、「①耐震設計上考慮している耐震壁」、 「②鉄筋コンクリート構造計算規程・同解説（日本建築学会）の規準上の耐震壁と同等な耐震壁」に分類する。</p> <p>3. 水密区画の構造</p> <p>水密区画は下記に示す設計としており、溢水した保有水が区画外へ漏えいしない構造となっている。図1に水密区画の概要図を示す。</p> <p>①区画壁は鉄筋コンクリート造の壁であり地震時に倒壊、損傷しない強度を有するとともに、耐水性のあるエポキシ樹脂系塗料にて塗装が施している。</p> <p>②区画入口は溢水高さ以上に設置している。</p> <p>③溢水高さ以下の壁貫通部は、シール施工をしており、外部へ漏えいしない設計としている。また貫通配管は貫通部前後でサポート固定されており、貫通部シールに大きな荷重がかからないよう配慮している。</p> <p>④床ドレン配管の隔離弁は常時閉運用としており、水密区画内の漏水が検知できる設備を設置する。</p>	水密区画内設置機器	設置場所	タンク容量 (m ³)	室面積 (m ²)	溢水高さ (cm)	耐水塗膜高さ (cm)	室入口高さ (cm)	区画壁	A-濃縮液貯蔵タンク	原子炉	25	37.1	134.8	160	280	①、②	B-濃縮液貯蔵タンク	補助建屋 T.P. 17. 8m	25	A-冷却材貯蔵タンク	原子炉 補助建屋 T.P. 2. 8m	360	64. 46	558. 5	561	740	①	B-冷却材貯蔵タンク	原子炉 補助建屋 T.P. 2. 8m	360	64. 46	558. 5	561	740	①	A-使用済樹脂貯蔵タンク	原子炉	70	72. 17	291	295	810	①	B-使用済樹脂貯蔵タンク	補助建屋 T.P. 2. 8m	70	C-使用済樹脂貯蔵タンク		70	一次系純水タンク	原子炉 建屋 T.P. 17. 8m	365	92. 48	394. 7	395	690	①	<p>【伊方】 設計方針の相違 伊方ではタンク容量をインターロックによって設定される水位（全容量の90%）で評価しているが、泊は設計上のタンク全容量で設定し評価している。</p> <p>【伊方】 設備名称の相違 記載表現の相違</p> <p>【伊方】 記載表現の相違</p> <p>【伊方】 設計方針の相違 泊は漏えい検知器若しくは水位計の低警報によって漏えいが検知できる（システム検知）。</p>
水密区画内設置機器	設置位置	炉内容量	電源種	溢水高さ	耐水塗膜高さ	室入口高さ	区画壁																																																																																																																																																												
冷却材貯蔵炉A	A/B EL. 3. 3m	204基	150	3. 06 ^①	3. 7	3. 7	耐震壁 (①)																																																																																																																																																												
冷却材貯蔵炉B	A/B EL. 3. 3m																																																																																																																																																																		
使用済軽核貯蔵炉A	A/B EL. 3. 3m	77	35	2. 2	2. 4	8. 45	耐震壁 (①)																																																																																																																																																												
使用済軽核貯蔵炉B	A/B EL. 3. 3m	77	35	2. 2	2. 4	8. 45	耐震壁 (①)																																																																																																																																																												
使用済重油炉	A/B EL. 3. 3m	5. 3	16	0. 4	2. 1	3. 3	耐震壁 (①、②)																																																																																																																																																												
原液貯蔵炉A	A/B EL. 3. 3m	60	65	1. 0	2. 1	1. 6	耐震壁 (①)																																																																																																																																																												
原液貯蔵炉B	A/B EL. 3. 3m	60	65	1. 0	2. 1	1. 6	耐震壁 (①)																																																																																																																																																												
一次系純水炉	B/F EL. 10. 0m	510	170	3. 0	4. 0	7. 1	耐震壁 (①)																																																																																																																																																												
濃縮液投入炉A	A/F EL. 10. 0m	38	32	1. 2	2. 1	3. 6	耐震壁 (①、②)																																																																																																																																																												
濃縮液投入炉B	A/F EL. 10. 0m	38	32	1. 2	2. 1	3. 6	耐震壁 (①、②)																																																																																																																																																												
予備濃縮液炉	A/B EL. 10. 0m	12	10	0. 8	2. 1	1. 4	耐震壁 (①、②)																																																																																																																																																												
洗浄排水濃縮液投入炉	A/B EL. 10. 0m	12	11	1. 1	2. 1	1. 4	耐震壁 (①、②)																																																																																																																																																												
水密区画内設置機器	設置場所	タンク容量 (m ³)	室面積 (m ²)	溢水高さ (cm)	耐水塗膜高さ (cm)	室入口高さ (cm)	区画壁																																																																																																																																																												
A-濃縮液貯蔵タンク	原子炉	25	37.1	134.8	160	280	①、②																																																																																																																																																												
B-濃縮液貯蔵タンク	補助建屋 T.P. 17. 8m	25																																																																																																																																																																	
A-冷却材貯蔵タンク	原子炉 補助建屋 T.P. 2. 8m	360	64. 46	558. 5	561	740	①																																																																																																																																																												
B-冷却材貯蔵タンク	原子炉 補助建屋 T.P. 2. 8m	360	64. 46	558. 5	561	740	①																																																																																																																																																												
A-使用済樹脂貯蔵タンク	原子炉	70	72. 17	291	295	810	①																																																																																																																																																												
B-使用済樹脂貯蔵タンク	補助建屋 T.P. 2. 8m	70																																																																																																																																																																	
C-使用済樹脂貯蔵タンク		70																																																																																																																																																																	
一次系純水タンク	原子炉 建屋 T.P. 17. 8m	365	92. 48	394. 7	395	690	①																																																																																																																																																												

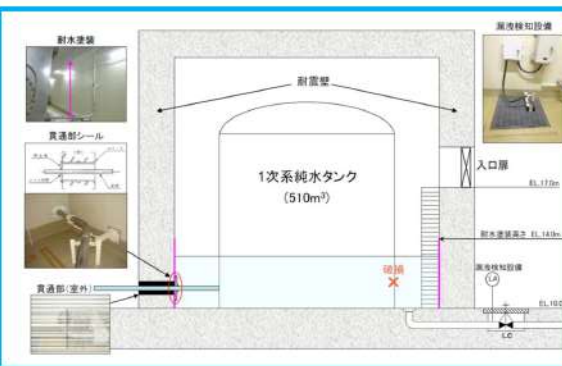
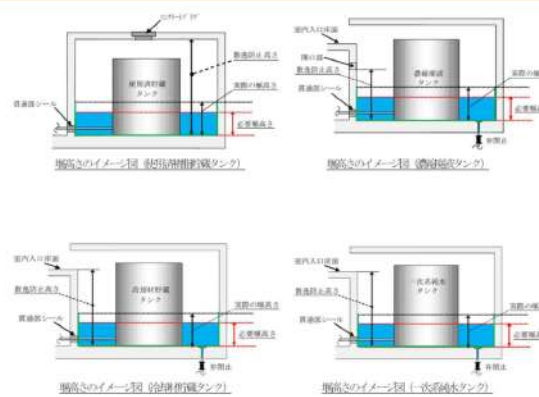
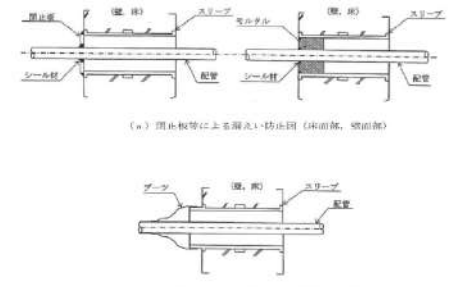
赤字：設備、運用又は体制の相違（設計方針の相違）
 青字：記載箇所又は記載内容の相違（記載方針の相違）
 緑字：記載表現、設備名称の相違（実質的な相違なし）

大阪発電所3/4号炉	女川原子力発電所2号炉	泊発電所3号炉	相違理由
<p>【参考】伊方発電所3号炉</p>  <p>図-1 水密区画概要図（1次系純水タンクの例）</p>		 <p>図1 水密区画内設置機器概要図</p>  <p>図2 貫通部シール施工概要図</p> <p><現地施工状況例></p>  <p>図3 貫通部シール施工例</p>	<p>【伊方】 <u>記載表現の相違</u></p> <ul style="list-style-type: none"> ・伊方は一例として1次系純水タンクを記載しているのに対し、泊は水密区画にあるタンクすべての概要図を記載し、設計が異なるものではないことを明示している。 ・水密区画の貫通部シール施工概要図及び貫通部シール施工例写真を図2及び図3として記載した（伊方は図-1の図中に記載）。

赤字：設備、運用又は体制の相違（設計方針の相違）
 青字：記載箇所又は記載内容の相違（記載方針の相違）
 緑字：記載表現、設備名称の相違（実質的な相違なし）

大阪発電所3/4号炉	女川原子力発電所2号炉	泊発電所3号炉	相違理由
<p>【参考】伊方発電所3号炉</p> <p>4. 鉄筋コンクリート壁の水密性について 水密区画の隔壁はマッシブな鉄筋コンクリートであるが、基準地震動 S_s による最大せん断ひずみがせん断力-せん断ひずみ線図上の第一折れ点を上回る層もあり、ひび割れの発生による漏水を否定できないため、ひび割れによる漏水量について検討を実施した。別紙3に検討結果を示す。</p>		<p>4. 鉄筋コンクリート壁の水密性について 水密区画の隔壁は耐震壁又は「鉄筋コンクリート構造計算規準・同解説（日本建築学会）」の規準上の耐震壁と同等な壁であるが、基準地震動による最大せん断ひずみがせん断力-せん断ひずみ線図上の第一折れ点を上回る層もあり、ひび割れの発生による漏水を否定できないため、ひび割れによる漏水量について検討した結果、最大残留ひび割れ幅は「維持管理指針」に示される評価基準である「0.2mm」を超えないことを確認した。補足説明資料29「内部溢水評価における耐震壁等の確認について」に検討結果を示す。</p>	<p>【伊方】 記載表現の相違 記載方針の相違</p> <ul style="list-style-type: none"> ・伊方は対象の隔壁を総称してマッシブな鉄筋コンクリートと表現しているが、泊は耐震壁及び規準上の耐震壁と同等な壁として分類し、記載している。（補足説明資料29） ・検討結果より、最終貯留区画の耐震壁及び規準上の耐震壁と同等な壁において、ひび割れによる漏水が極めて少量であり、溢水影響評価へ影響しないことを確認した。

赤字：設備、運用又は体制の相違 (設計方針の相違)
 青字：記載箇所又は記載内容の相違 (記載方針の相違)
 緑字：記載表現、設備名称の相違 (実質的な相違なし)

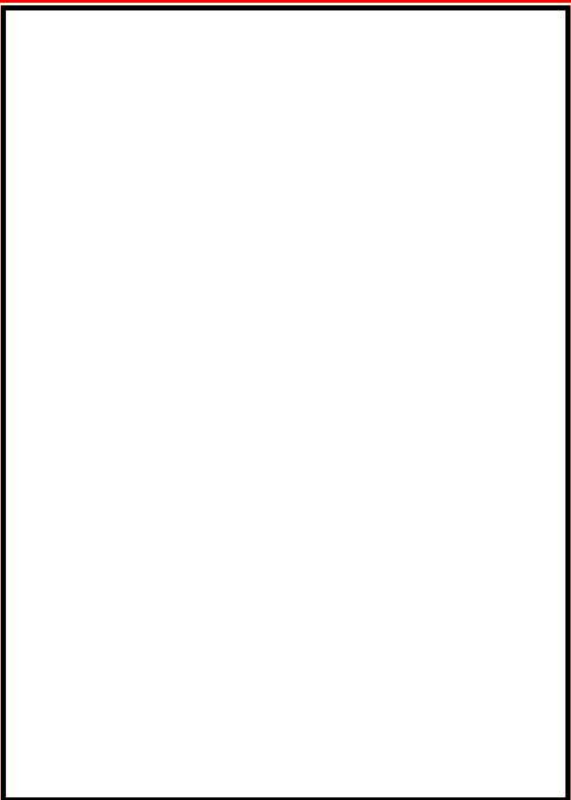
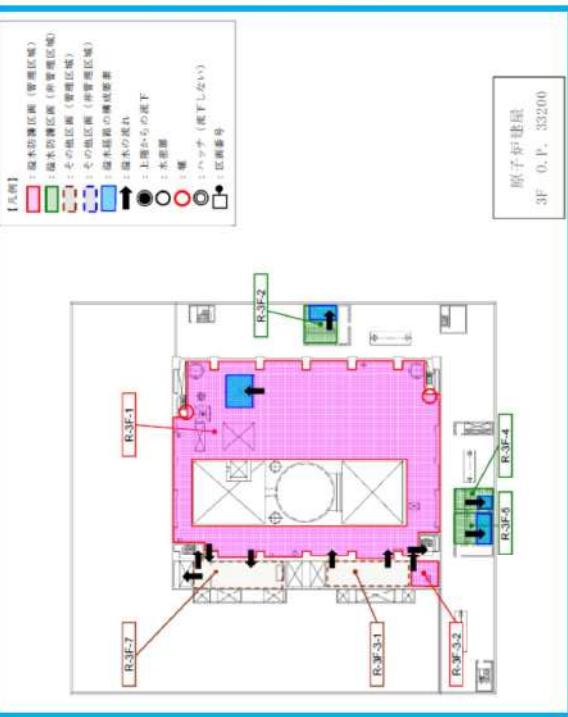
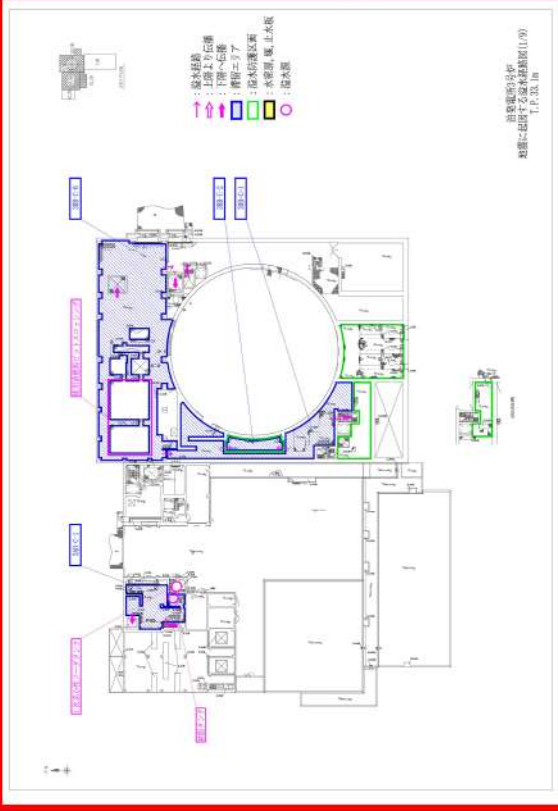
大阪発電所3/4号炉	女川原子力発電所2号炉	泊発電所3号炉	相違理由
添付資料 1.4.3-3	添付資料 10	添付資料 10	
	<p data-bbox="869 213 1093 236">溢水伝播経路図 (平面図)</p>  <p data-bbox="1205 320 1265 448">原子炉建屋 3F 0. P. 332/00</p>	<p data-bbox="1451 213 1675 236">溢水伝播経路図 (平面図)</p> <p data-bbox="1294 248 1697 271">1. 地震に起因する溢水経路及び溢水防護区画</p>  <p data-bbox="1794 312 1832 448">泊発電所3号炉 1. F. 3. 1m 地震に起因する溢水経路図(1/3)</p>	<p data-bbox="1877 181 1928 204">【大阪】</p> <p data-bbox="1877 217 1995 239">記載表現の相違</p> <p data-bbox="1877 252 1928 274">【女川】</p> <p data-bbox="1877 287 1995 309">記載方針の相違</p> <p data-bbox="1877 322 2123 513">女川では、地震起因、消火放水、想定破損による溢水によらず防護区画図上に溢水の伝播経路を示しているが、泊は溢水源によって溢水経路及び溢水防護区画を設定している。(大阪と同様)</p> <p data-bbox="1877 526 1928 549">【大阪】</p> <p data-bbox="1877 561 1995 584">設計方針の相違</p> <p data-bbox="1877 596 2024 619">プラント設計の相違</p>
<p data-bbox="114 1059 683 1082">枠組みの範囲は機密に係る事項ですので公開することはできません。</p>			

赤字：設備、運用又は体制の相違（設計方針の相違）
 青字：記載箇所又は記載内容の相違（記載方針の相違）
 緑字：記載表現、設備名称の相違（実質的な相違なし）

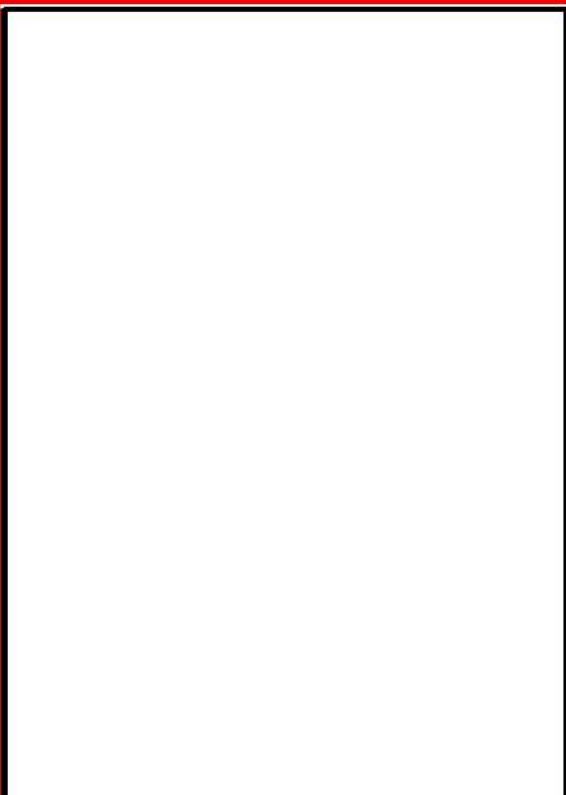
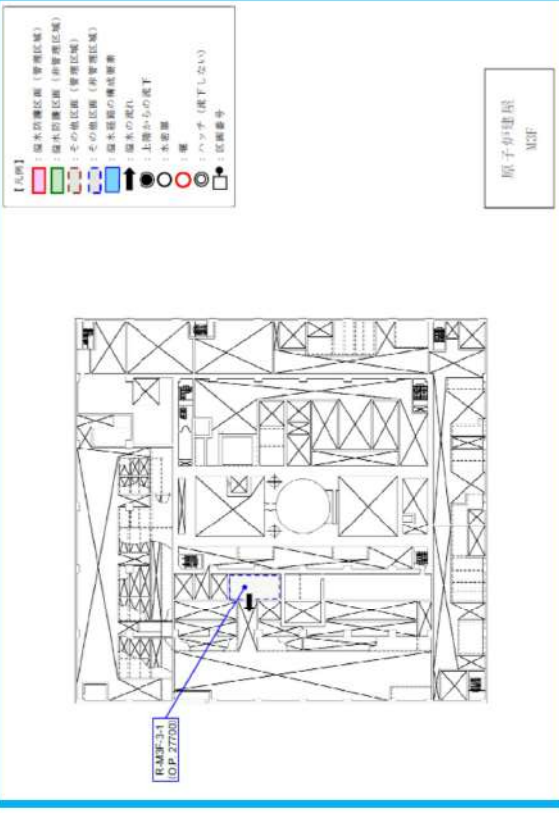
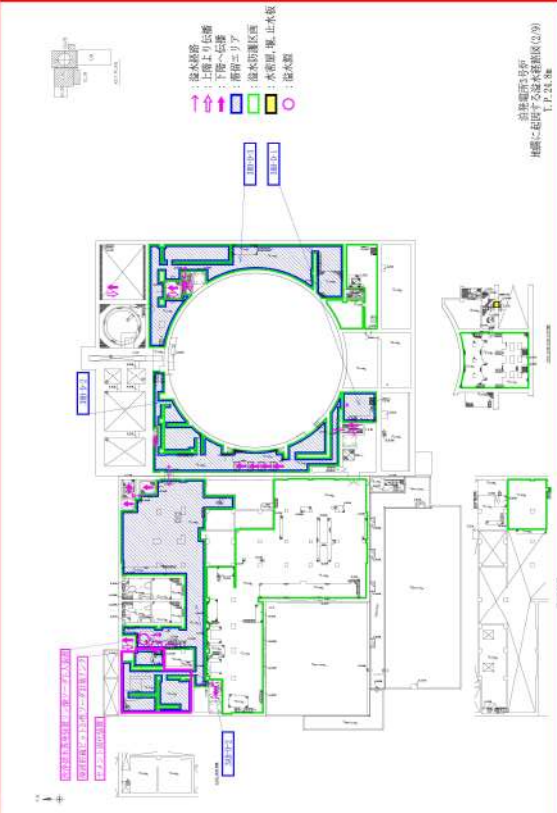
大阪発電所3/4号炉	女川原子力発電所2号炉	泊発電所3号炉	相違理由
			<p>【女川】 <u>記載方針の相違</u> 女川では、地震起因、消火放水、想定破損による溢水によらず防護区画図上に溢水の伝播経路を示しているが、泊は溢水源によって溢水経路及び溢水防護区画を設定している。（大阪と同様）</p> <p>【大阪】 <u>設計方針の相違</u> <u>プラント設計の相違</u></p>
<p>特組みの範囲は機密に係る事項ですので公開することはできません。</p>			

赤字：設備、運用又は体制の相違（設計方針の相違）
 青字：記載箇所又は記載内容の相違（記載方針の相違）
 緑字：記載表現、設備名称の相違（実質的な相違なし）

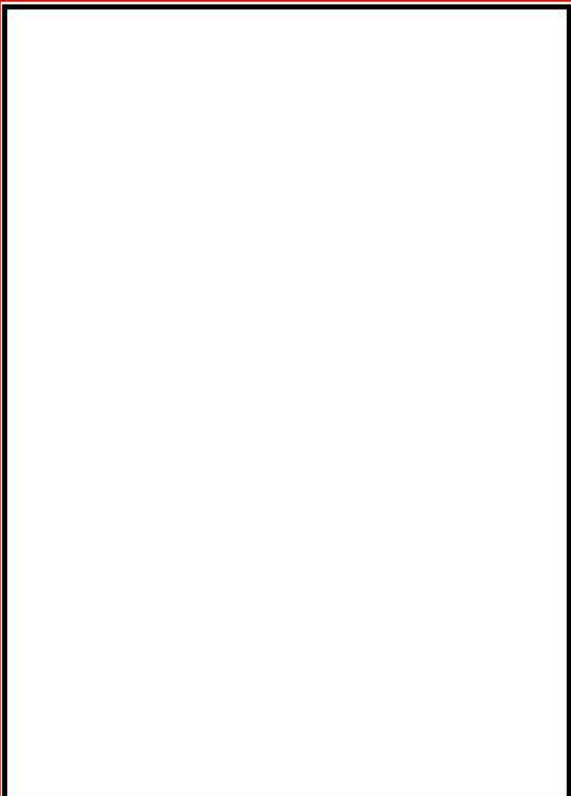
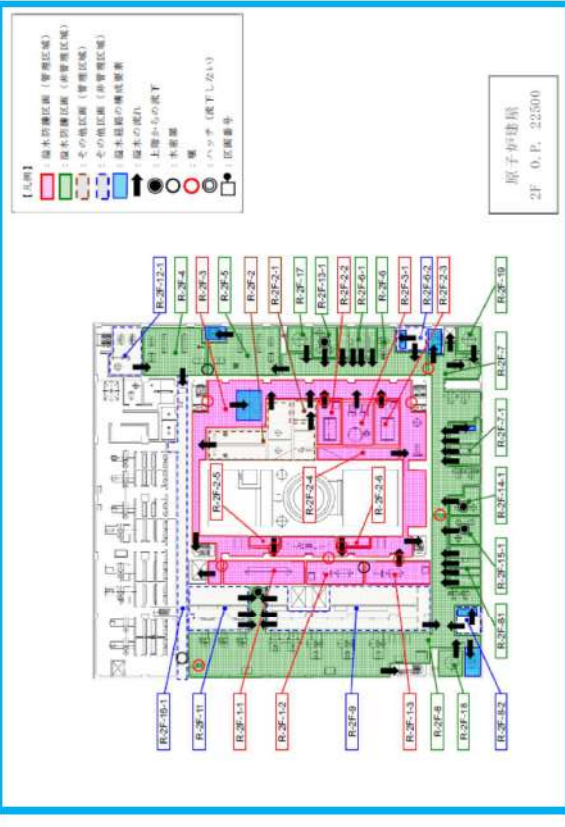
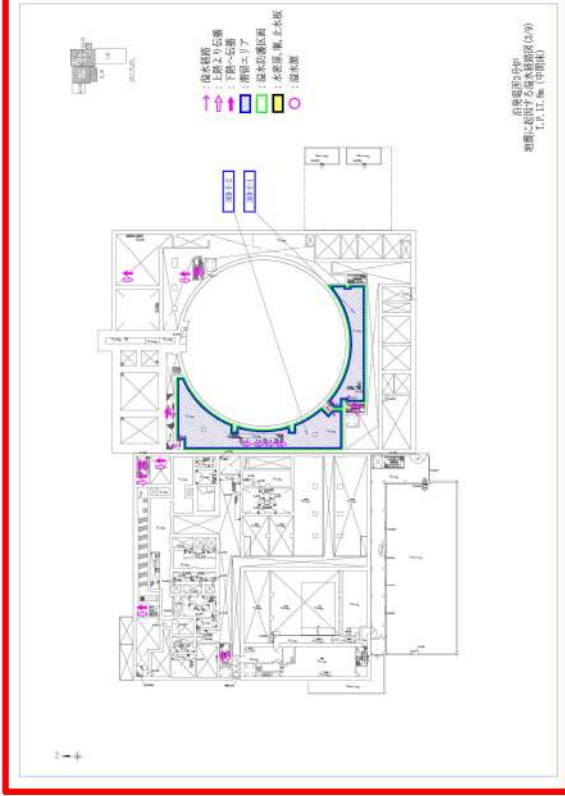
大阪発電所3/4号炉	女川原子力発電所2号炉	泊発電所3号炉	相違理由
			<p>【女川】 記載方針の相違 女川では、地震起因、消火水放水、想定破損による溢水によらず防護区画図上に溢水の伝播経路を示しているが、泊は溢水源によって溢水経路及び溢水防護区画を設定している。（大阪と同様）</p> <p>【大阪】 設計方針の相違 プラント設計の相違</p>
<p>枠組みの範囲は機密に係る事項ですので公開することはできません。</p>			

赤字：設備、運用又は体制の相違（設計方針の相違）
 青字：記載箇所又は記載内容の相違（記載方針の相違）
 緑字：記載表現、設備名称の相違（実質的な相違なし）

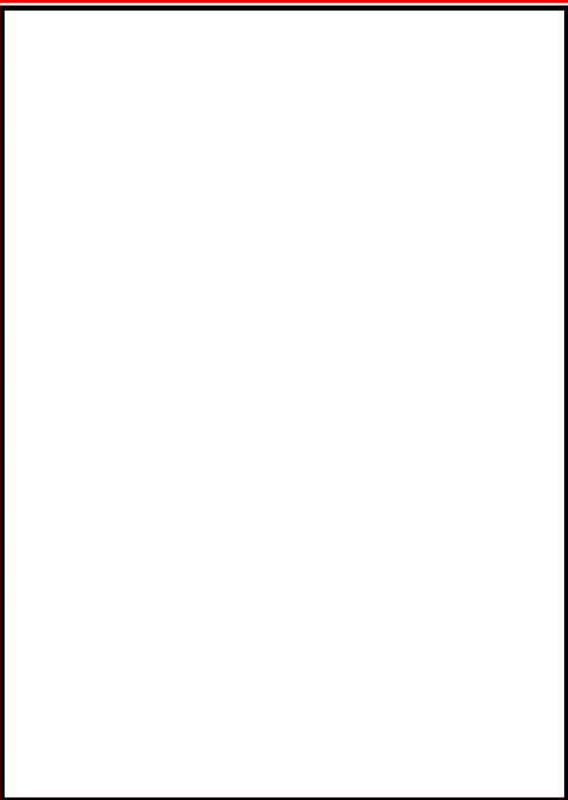
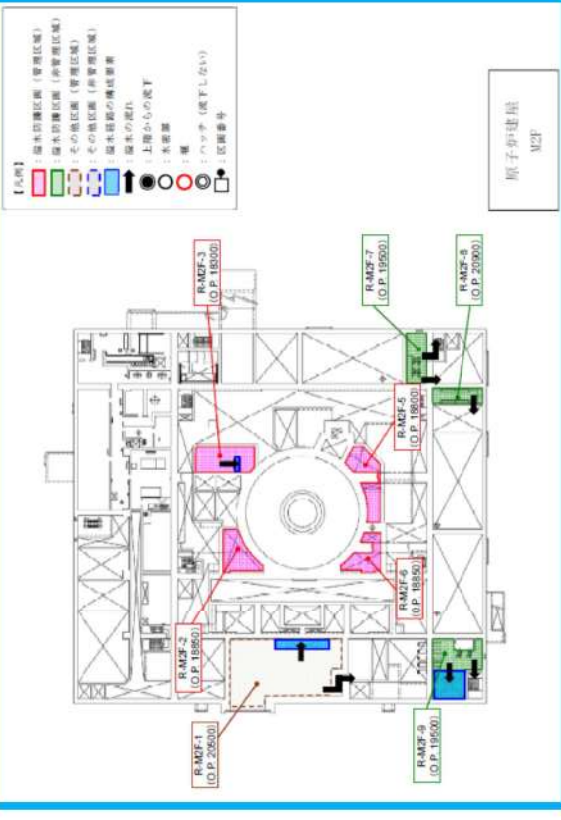
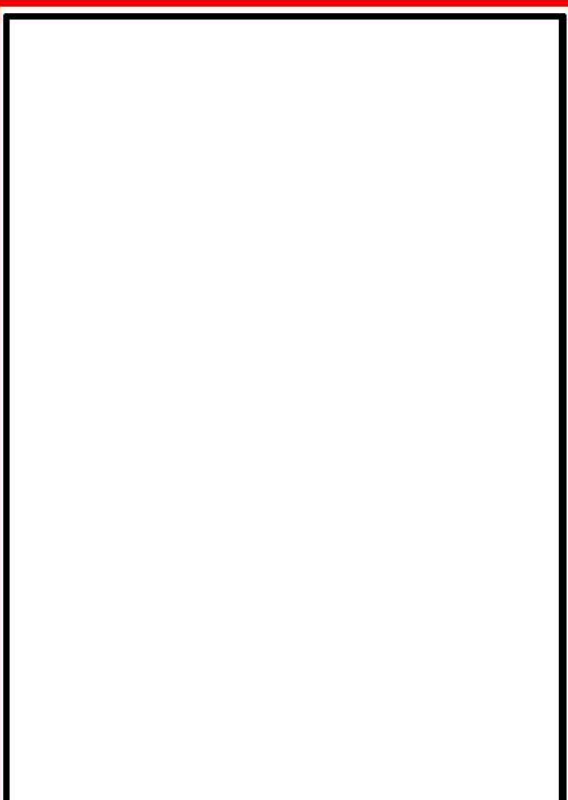
大阪発電所3/4号炉	女川原子力発電所2号炉	泊発電所3号炉	相違理由
			<p>【女川】 記載方針の相違 女川では、地震起因、消火放水、想定破損による溢水によらず防護区画図上に溢水の伝播経路を示しているが、泊は溢水源によって溢水経路及び溢水防護区画を設定している。（大阪と同様）</p> <p>【大阪】 設計方針の相違 プラント設計の相違</p>
<p>持組みの範囲は機密に係る事項ですので公開することはできません。</p>		<p>枠囲みの内容は機密情報に属しますので公開できません。</p>	

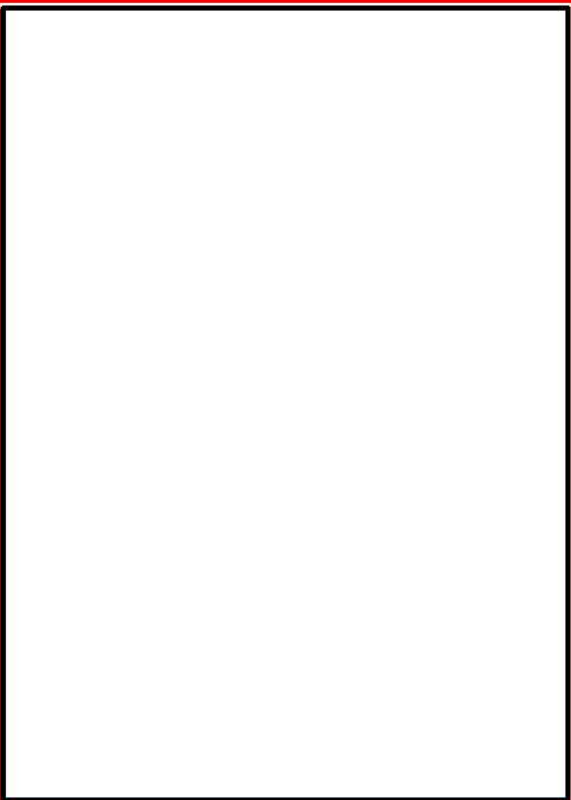
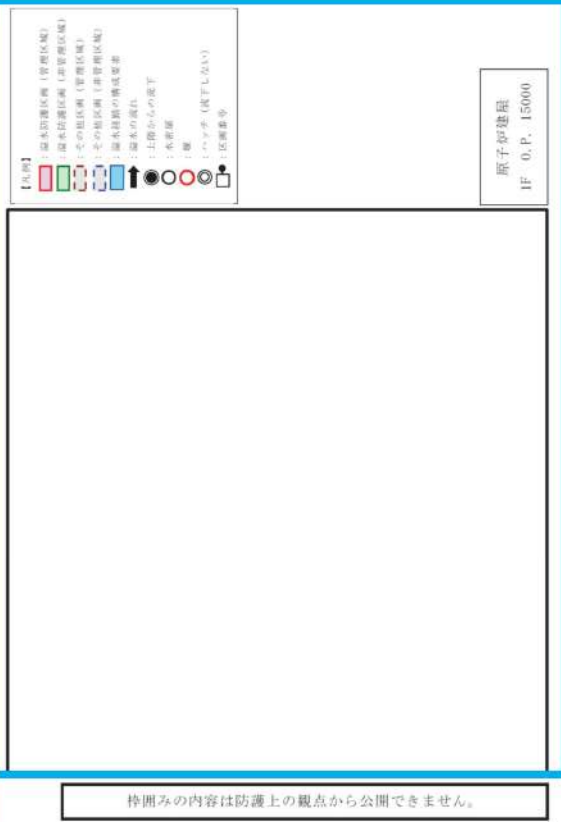
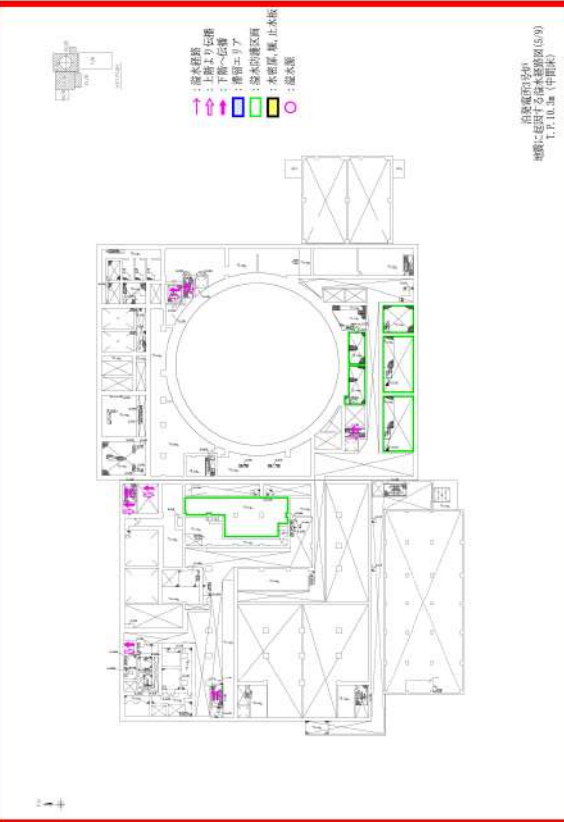

赤字：設備、運用又は体制の相違（設計方針の相違）
 青字：記載箇所又は記載内容の相違（記載方針の相違）
 緑字：記載表現、設備名称の相違（実質的な相違なし）

大阪発電所3/4号炉	女川原子力発電所2号炉	泊発電所3号炉	相違理由
			<p>【女川】 <u>記載方針の相違</u> 女川では、地震起因、消火放水、想定破損による溢水によらず防護区画図上に溢水の伝播経路を示しているが、泊は溢水源によって溢水経路及び溢水防護区画を設定している。（大阪と同様）</p> <p>【大阪】 <u>設計方針の相違</u> プラント設計の相違</p>
<p>枠組みの範囲は機密に係る事項ですので公開することはできません。</p>	<p>枠組みの内容は防護上の観点から公開できません。</p>	<p>枠組みの内容は防護上の観点から公開できません。</p>	

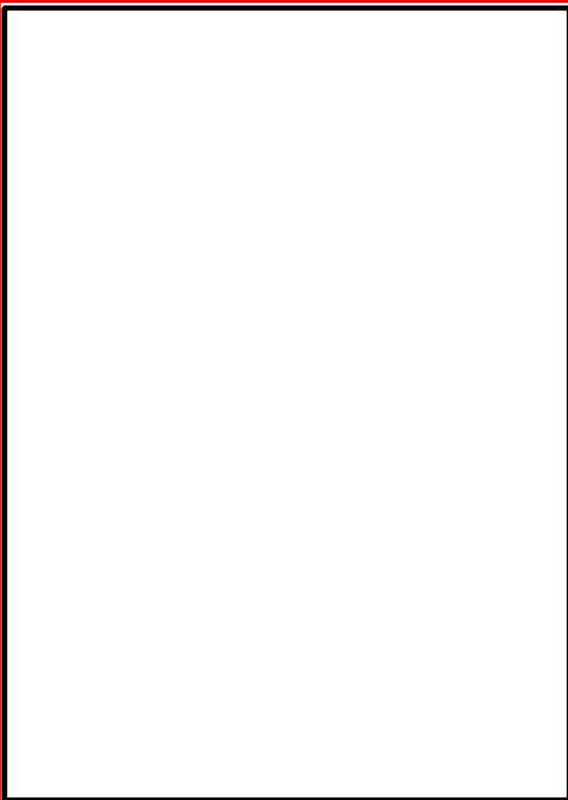
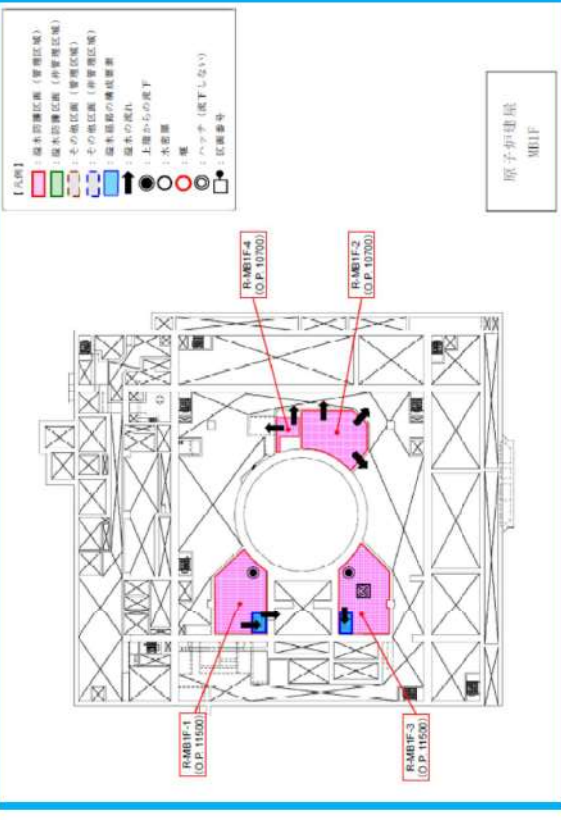
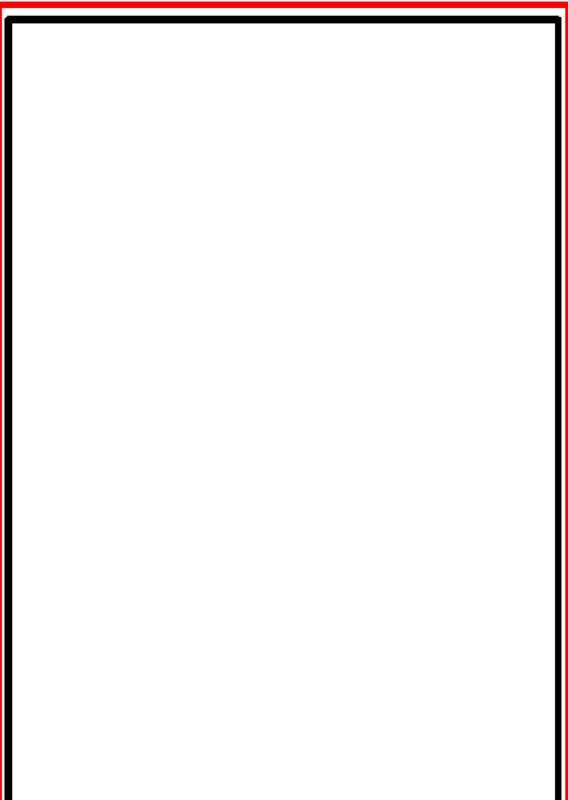
赤字：設備、運用又は体制の相違（設計方針の相違）
 青字：記載箇所又は記載内容の相違（記載方針の相違）
 緑字：記載表現、設備名称の相違（実質的な相違なし）

大阪発電所3/4号炉	女川原子力発電所2号炉	泊発電所3号炉	相違理由
			<p>【女川】 <u>記載方針の相違</u> 女川では、地震起因、消火水放水、想定破損による溢水によらず防護区画図上に溢水の伝播経路を示しているが、泊は溢水源によって溢水経路及び溢水防護区画を設定している。（大阪と同様）</p> <p>【大阪】 <u>設計方針の相違</u> プラント設計の相違</p>
<p>棒囲みの範囲は機密に係る事項ですので公開することはできません。</p>		<p>棒囲みの内容は機密情報に属しますので公開できません。</p>	

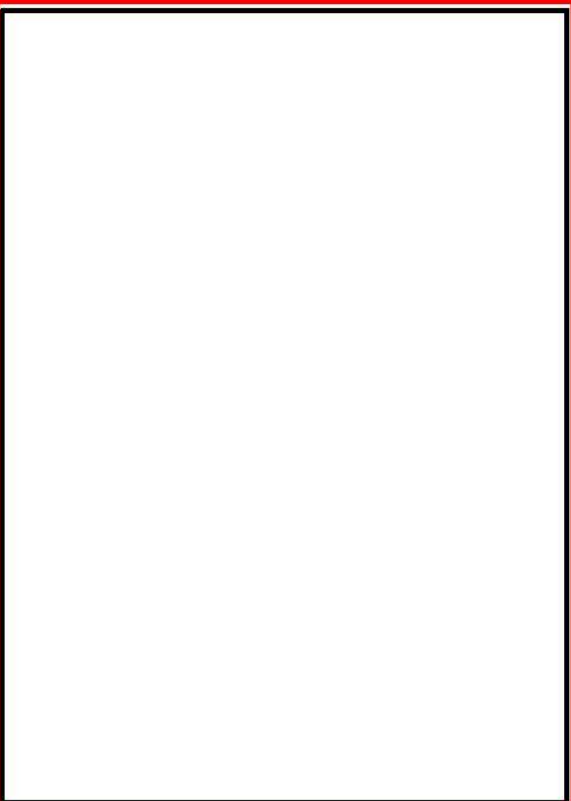
赤字：設備、運用又は体制の相違（設計方針の相違）
 青字：記載箇所又は記載内容の相違（記載方針の相違）
 緑字：記載表現、設備名称の相違（実質的な相違なし）

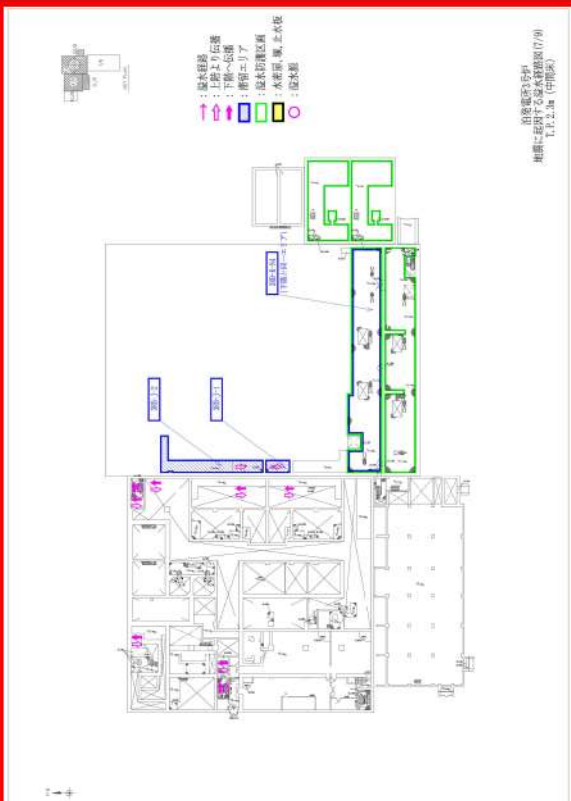
大阪発電所3/4号炉	女川原子力発電所2号炉	泊発電所3号炉	相違理由
			<p>【女川】 記載方針の相違 女川では、地震起因、消火放水、想定破損による溢水によらず防護区画図上に溢水の伝播経路を示しているが、泊は溢水源によって溢水経路及び溢水防護区画を設定している。（大阪と同様）</p> <p>【大阪】 設計方針の相違 プラント設計の相違</p>
<p>枠組みの範囲は機密に係る事項ですので公開することはできません。</p>			

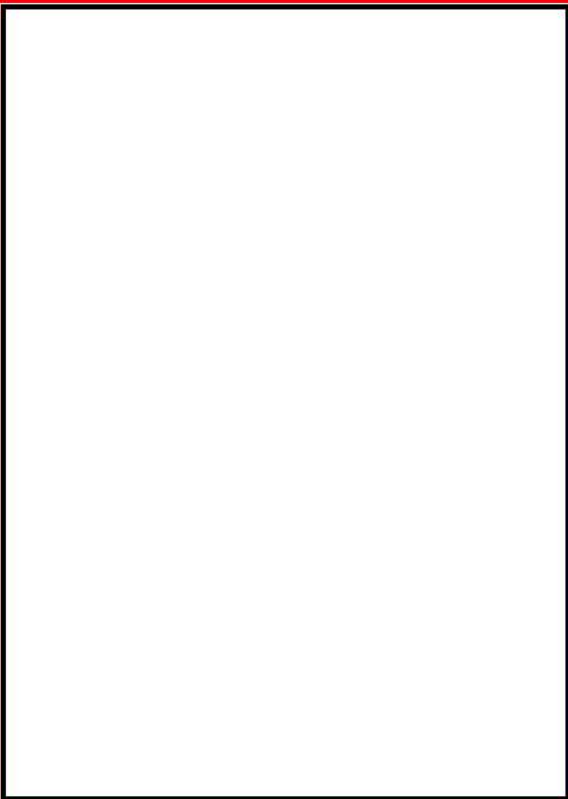
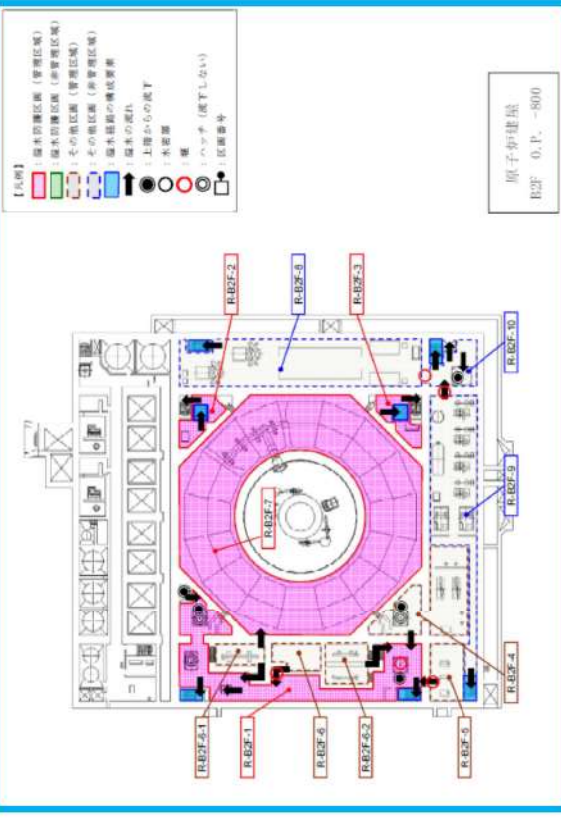
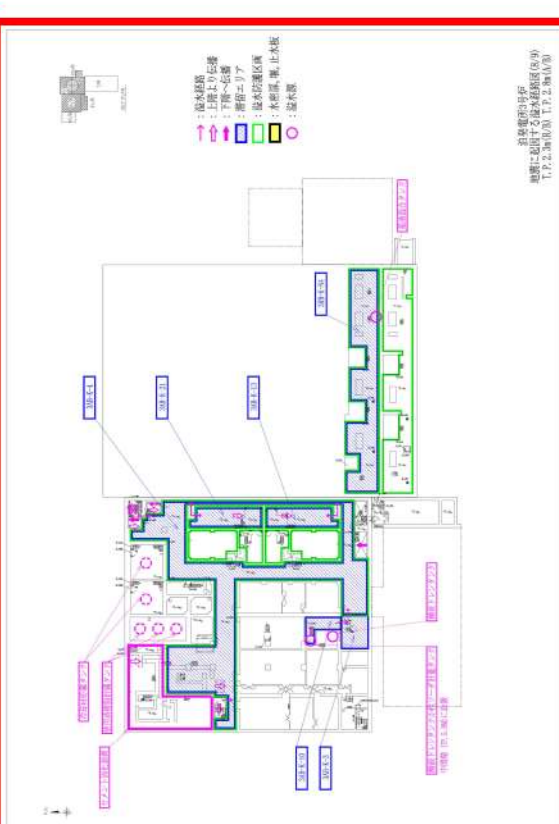

赤字：設備、運用又は体制の相違（設計方針の相違）
 青字：記載箇所又は記載内容の相違（記載方針の相違）
 緑字：記載表現、設備名称の相違（実質的な相違なし）

大阪発電所3/4号炉	女川原子力発電所2号炉	泊発電所3号炉	相違理由
	 <p>原子炉建屋 R2F 0, P. -800</p>		<p>【女川】 <u>記載方針の相違</u> 女川では、地震起因、消火放水、想定破損による溢水によらず防護区画図上に溢水の伝播経路を示しているが、泊は溢水源によって溢水経路及び溢水防護区画を設定している。（大阪と同様）</p> <p>【大阪】 <u>設計方針の相違</u> プラント設計の相違</p>
<p>枠組みの範囲は機密に係る事項ですので公開することはできません。</p>			

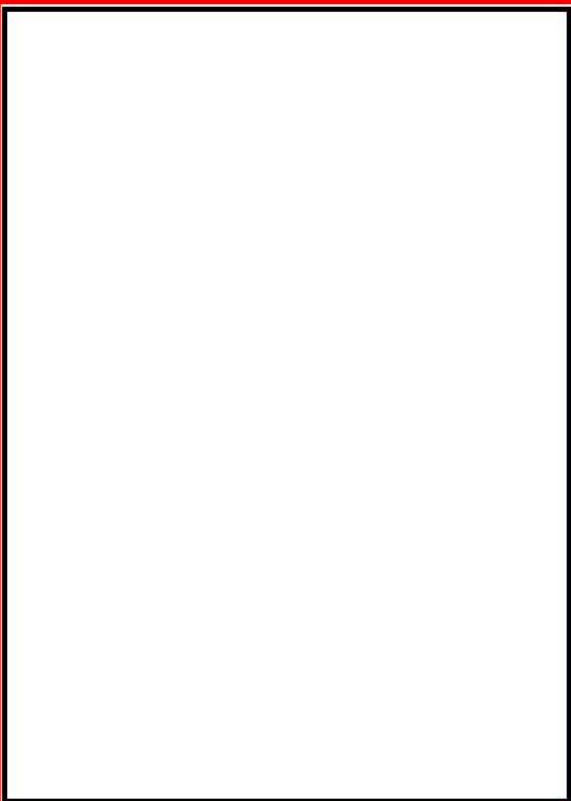
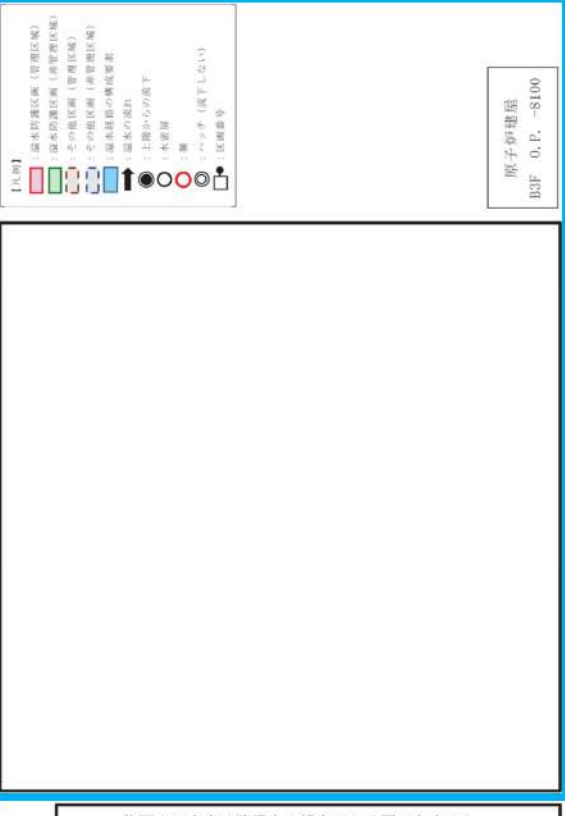
赤字：設備、運用又は体制の相違（設計方針の相違）
 青字：記載箇所又は記載内容の相違（記載方針の相違）
 緑字：記載表現、設備名称の相違（実質的な相違なし）

大阪発電所3/4号炉	女川原子力発電所2号炉	泊発電所3号炉	相違理由
	 <p style="text-align: center;">原子炉建屋 B3F 0.F. -8100</p>		<p>【女川】 <u>記載方針の相違</u> 女川では、地震起因、消火放水、想定破損による溢水によらず防護区画図上に溢水の伝播経路を示しているが、泊は溢水源によって溢水経路及び溢水防護区画を設定している。（大阪と同様）</p> <p>【大阪】 <u>設計方針の相違</u> プラント設計の相違</p>
<p>枠組みの範囲は機密に係る事項ですので公開することはできません。</p>	<p>枠組みの内容は防護上の観点から公開できません。</p>		

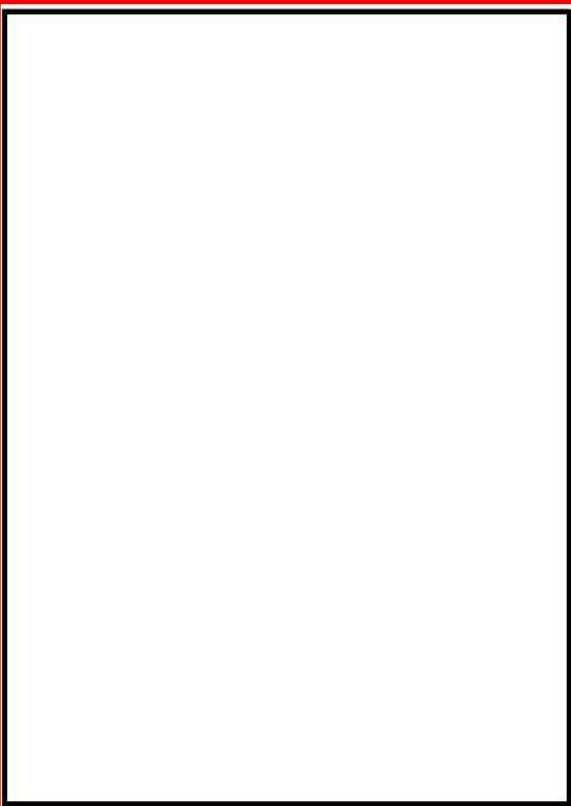

赤字：設備、運用又は体制の相違（設計方針の相違）
 青字：記載箇所又は記載内容の相違（記載方針の相違）
 緑字：記載表現、設備名称の相違（実質的な相違なし）

大阪発電所3/4号炉	女川原子力発電所2号炉	泊発電所3号炉	相違理由
 <p data-bbox="114 1023 683 1050">枠組みの範囲は機密に係る事項ですので公開することはできません。</p>	 <p data-bbox="770 1002 1256 1029">枠組みの内容は防護上の観点から公開できません。</p>		<p data-bbox="1874 177 2130 443"> 【女川】 <u>記載方針の相違</u> 女川では、地震起因、消火放水、想定破損による溢水によらず防護区画図上に溢水の伝播経路を示しているが、泊は溢水源によって溢水経路及び溢水防護区画を設定している。（大阪と同様） </p> <p data-bbox="1874 451 2130 544"> 【大阪】 <u>設計方針の相違</u> プラント設計の相違 </p>

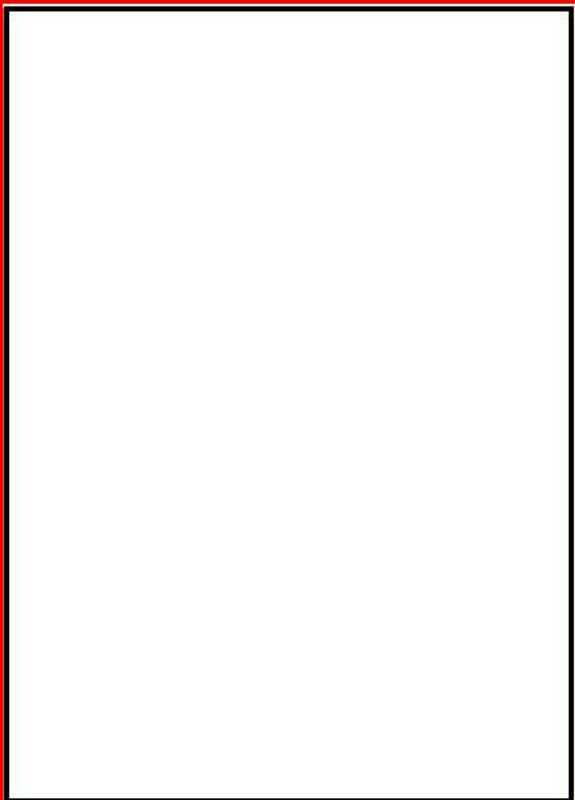
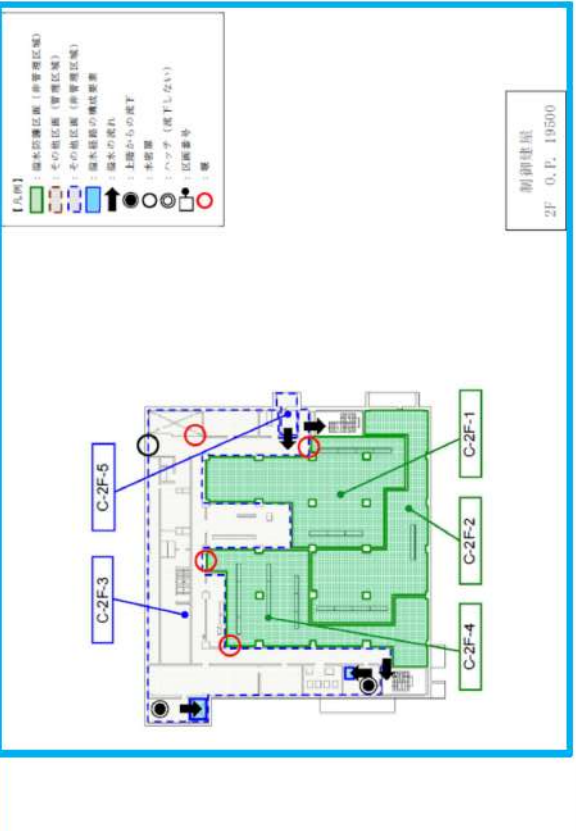
赤字：設備、運用又は体制の相違（設計方針の相違）
 青字：記載箇所又は記載内容の相違（記載方針の相違）
 緑字：記載表現、設備名称の相違（実質的な相違なし）

大阪発電所3/4号炉	女川原子力発電所2号炉	泊発電所3号炉	相違理由
			<p>【女川】 <u>記載方針の相違</u> 女川では、地震起因、消火水放水、想定破損による溢水によらず防護区画図上に溢水の伝播経路を示しているが、泊は溢水源によって溢水経路及び溢水防護区画を設定している。（大阪と同様）</p> <p>【大阪】 <u>設計方針の相違</u> プラント設計の相違</p>
<p>枠組みの範囲は機密に係る事項ですので公開することはできません。</p>			

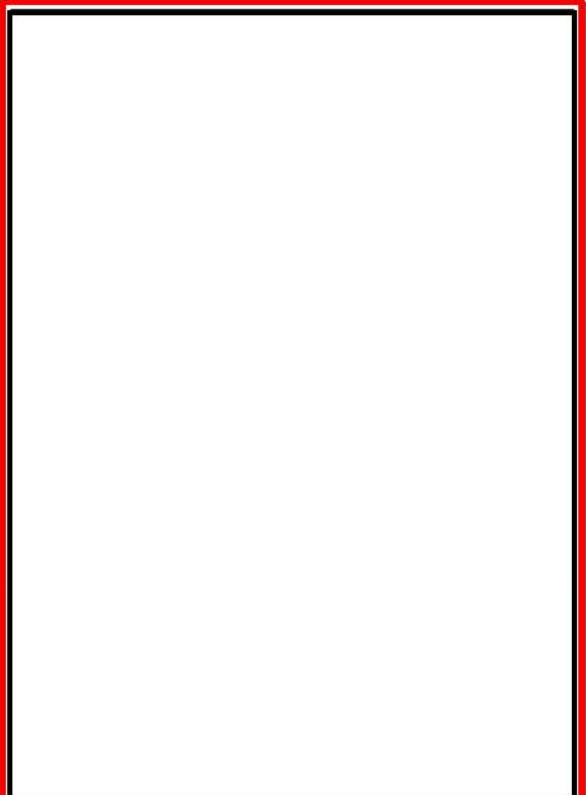
赤字：設備、運用又は体制の相違（設計方針の相違）
 青字：記載箇所又は記載内容の相違（記載方針の相違）
 緑字：記載表現、設備名称の相違（実質的な相違なし）

大阪発電所3/4号炉	女川原子力発電所2号炉	泊発電所3号炉	相違理由
 <p data-bbox="264 1021 672 1045">枠組みの範囲は機密に係る事項ですので公開することはできません。</p>	 <p data-bbox="772 1005 1198 1029">枠組みの内容は防護上の観点から公開できません。</p>		<p data-bbox="1870 175 1937 199">【女川】</p> <p data-bbox="1870 215 2004 239">記載方針の相違</p> <p data-bbox="1870 247 2128 438">女川では、地震起因、消火放水、想定破損による溢水によらず防護区画図上に溢水の伝播経路を示しているが、泊は溢水源によって溢水経路及び溢水防護区画を設定している。（大阪と同様）</p> <p data-bbox="1870 454 1937 478">【大阪】</p> <p data-bbox="1870 486 2004 510">設計方針の相違</p> <p data-bbox="1870 518 2027 542">プラント設計の相違</p>

赤字：設備、運用又は体制の相違（設計方針の相違）
 青字：記載箇所又は記載内容の相違（記載方針の相違）
 緑字：記載表現、設備名称の相違（実質的な相違なし）

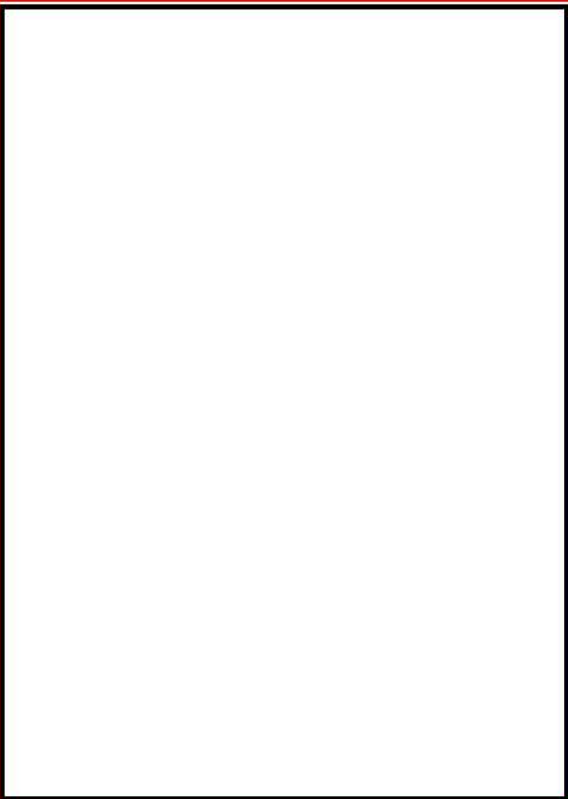
大阪発電所3/4号炉	女川原子力発電所2号炉	泊発電所3号炉	相違理由
	 <p>【凡例】</p> <ul style="list-style-type: none"> 溢水防護区画（非常時区域） その他区域画（管理区域） その他区域画（非常時区域） 溢水防護の構成要素 溢水の流れ 上層からの落下 基礎層 ハッチ（落下しない） 区画壁等 壁 <p>補助建屋 MBIF 0.P. 11400</p> <p>C-MBIF-1</p>		<p>【女川】 <u>記載方針の相違</u> 女川では、地震起因、消火放水、想定破損による溢水によらず防護区画図上に溢水の伝播経路を示しているが、泊は溢水源によって溢水経路及び溢水防護区画を設定している。（大阪と同様）</p> <p>【大阪】 <u>設計方針の相違</u> プラント設計の相違</p>
<p>種別みの範囲は機密に係る事項ですので公開することはできません。</p>			

赤字：設備、運用又は体制の相違（設計方針の相違）
 青字：記載箇所又は記載内容の相違（記載方針の相違）
 緑字：記載表現、設備名称の相違（実質的な相違なし）

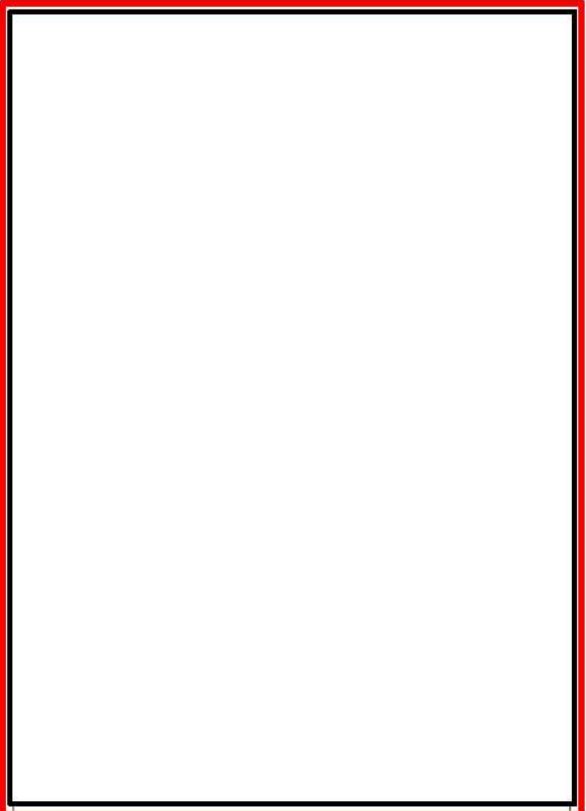
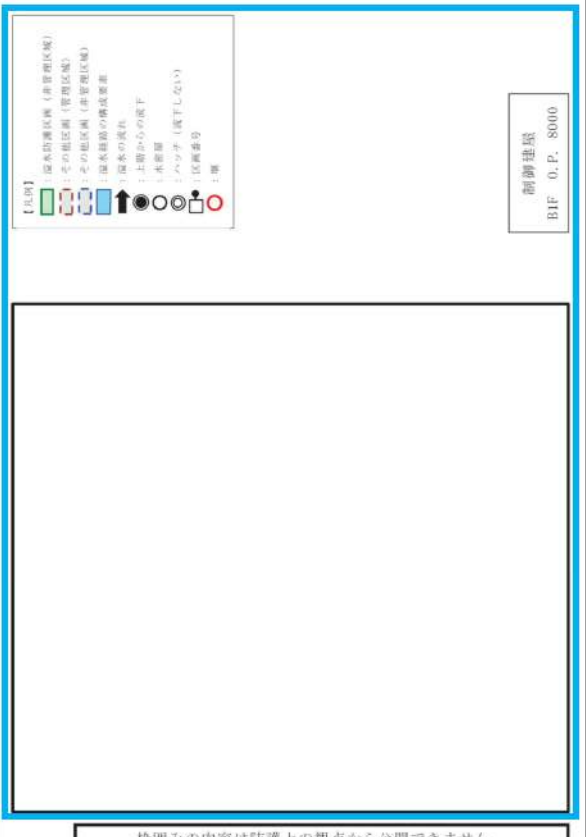
大阪発電所3/4号炉	女川原子力発電所2号炉	泊発電所3号炉	相違理由
 <p data-bbox="112 1023 683 1050">枠組みの範囲は機密に係る事項ですので公開することはできません。</p>	 <p data-bbox="772 1010 1261 1034">枠組みの内容は防護上の観点から公開できません。</p>		<p data-bbox="1872 177 2136 443"> 【女川】 <u>記載方針の相違</u> 女川では、地震起因、消火水放水、想定破損による溢水によらず防護区画図上に溢水の伝播経路を示しているが、泊は溢水源によって溢水経路及び溢水防護区画を設定している。（大阪と同様） </p> <p data-bbox="1872 451 2136 544"> 【大阪】 <u>設計方針の相違</u> プラント設計の相違 </p>

赤字：設備、運用又は体制の相違（設計方針の相違）
 青字：記載箇所又は記載内容の相違（記載方針の相違）
 緑字：記載表現、設備名称の相違（実質的な相違なし）

第9条 溢水による損傷の防止等（別添1 添付資料10）

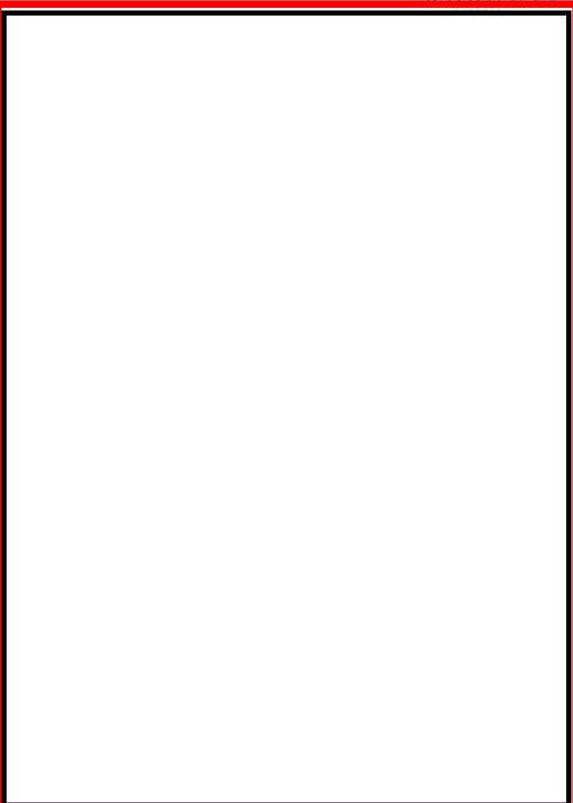
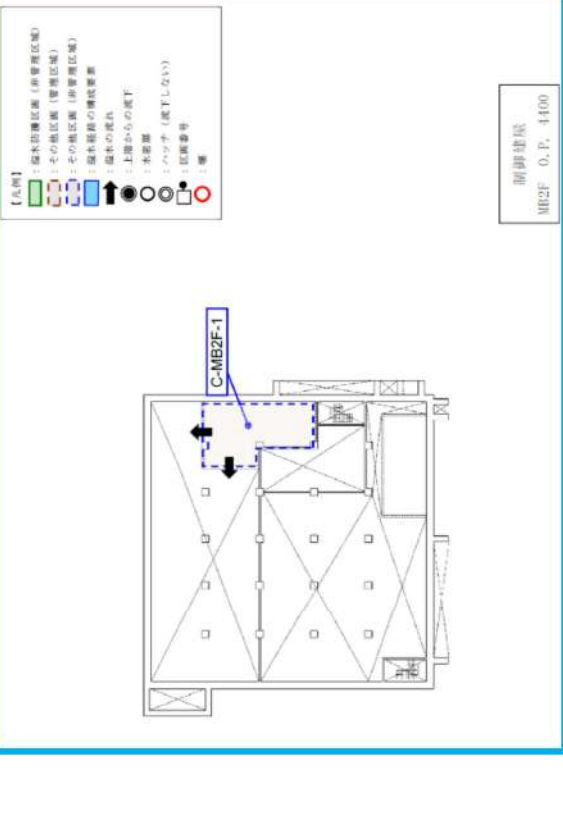
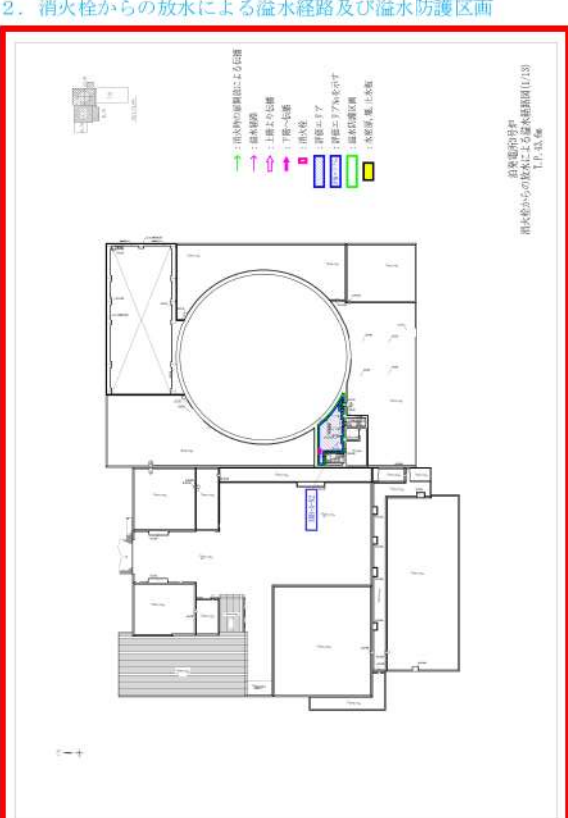
大阪発電所3/4号炉	女川原子力発電所2号炉	泊発電所3号炉	相違理由
<p style="color: green;">添付資料1.4.2-3</p> 	<p style="color: blue;">2. 消火栓からの放水による溢水経路及び溢水防護区画</p>  <p style="text-align: right;">副建屋 MB2F O.P. 4400</p>	 <p style="text-align: right;">副建屋 MB2F O.P. 4400</p>	<p>【女川】 <u>記載方針の相違</u> 女川では、地震起因、消火水放水、想定破損による溢水によらず防護区画図上に溢水の伝播経路を示しているが、泊は溢水源によって溢水経路及び溢水防護区画を設定している。（大阪と同様）</p> <p>【大阪】 <u>設計方針の相違</u> <u>プラント設計の相違</u> <u>記載表現の相違</u></p>
<p>枠組みの範囲は機密に係る事項ですので公開することはできません。</p>			

赤字：設備、運用又は体制の相違（設計方針の相違）
 青字：記載箇所又は記載内容の相違（記載方針の相違）
 緑字：記載表現、設備名称の相違（実質的な相違なし）

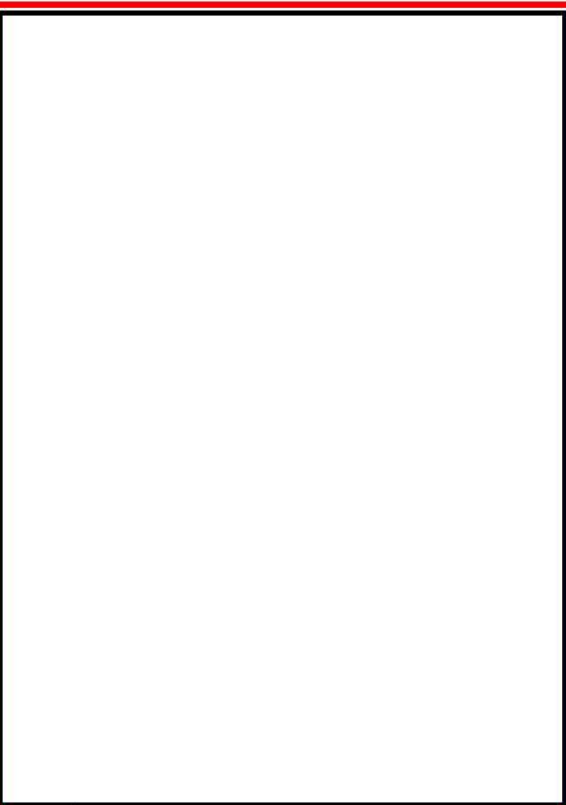
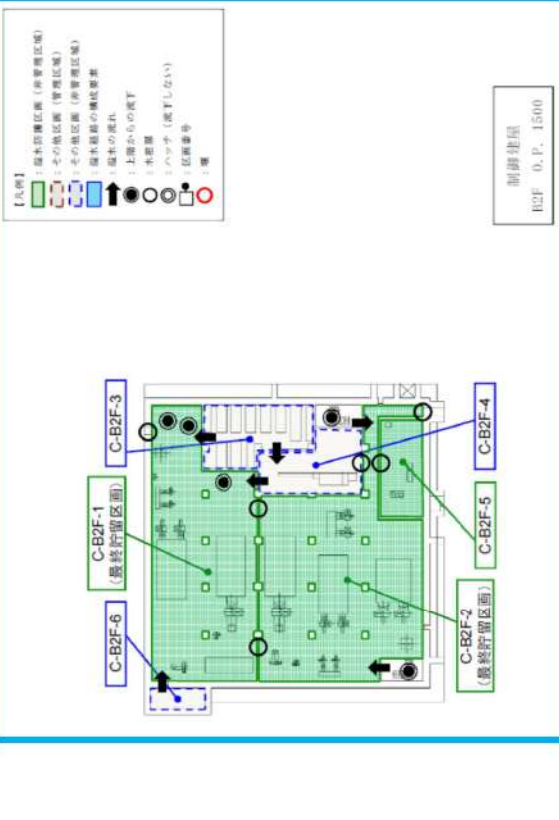
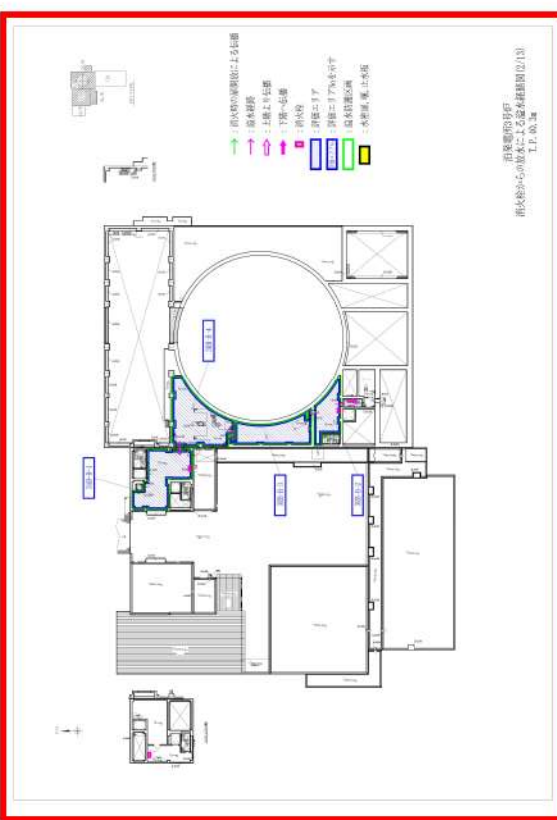
大阪発電所3/4号炉	女川原子力発電所2号炉	泊発電所3号炉	相違理由
			<p>【女川】 <u>記載方針の相違</u> 女川では、地震起因、消火放水、想定破損による溢水によらず防護区画図上に溢水の伝播経路を示しているが、泊は溢水源によって溢水経路及び溢水防護区画を設定している。（大阪と同様）</p> <p>【大阪】 <u>設計方針の相違</u> プラント設計の相違</p>
<p>枠組みの範囲は機密に係る事項ですので公開することはできません。</p>			

赤字：設備、運用又は体制の相違（設計方針の相違）
 青字：記載箇所又は記載内容の相違（記載方針の相違）
 緑字：記載表現、設備名称の相違（実質的な相違なし）

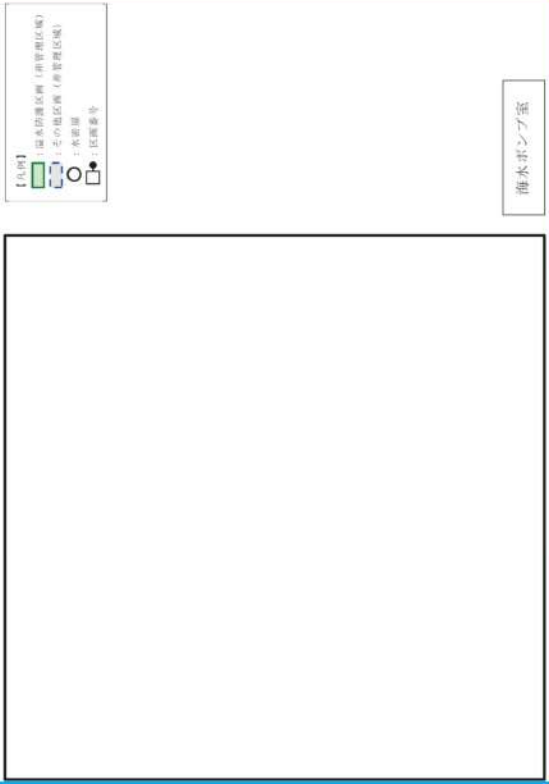
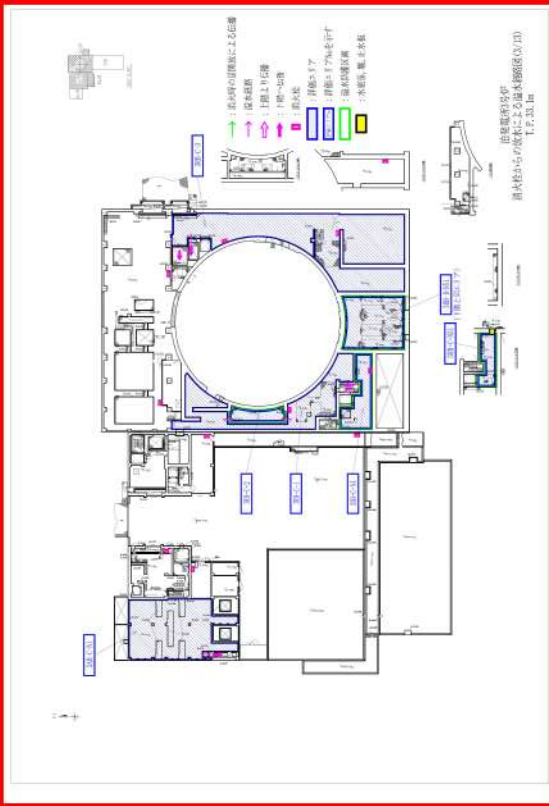
大阪発電所3/4号炉	女川原子力発電所2号炉	泊発電所3号炉	相違理由
	 <p data-bbox="772 981 1249 1008">枠囲みの内容は防護上の観点から公開できません。</p>		<p data-bbox="1877 183 1937 204">【女川】</p> <p data-bbox="1877 215 2123 443">記載方針の相違 女川では、地震起因、消火放水、想定破損による溢水によらず防護区画図上に溢水の伝播経路を示しているが、泊は溢水源によって溢水経路及び溢水防護区画を設定している。（大阪と同様）</p> <p data-bbox="1877 454 1937 475">【大阪】</p> <p data-bbox="1877 486 2027 545">設計方針の相違 プラント設計の相違</p>

赤字：設備、運用又は体制の相違（設計方針の相違）
 青字：記載箇所又は記載内容の相違（記載方針の相違）
 緑字：記載表現、設備名称の相違（実質的な相違なし）

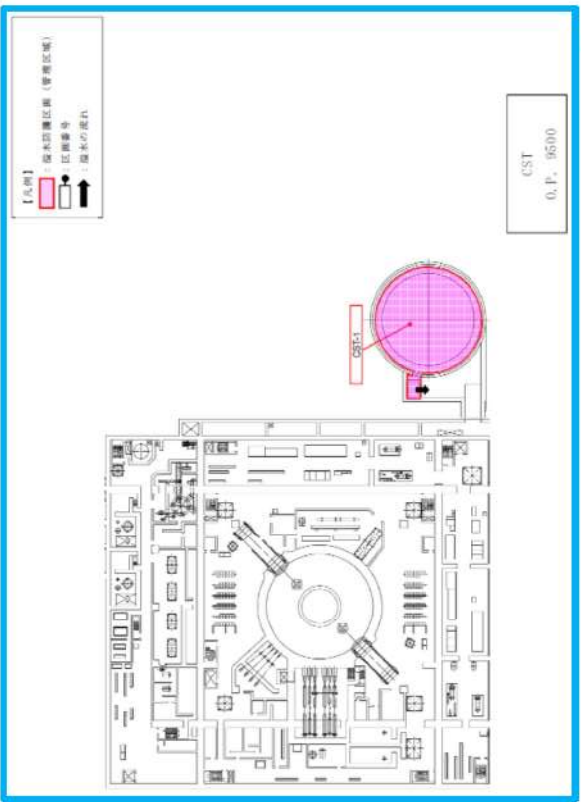
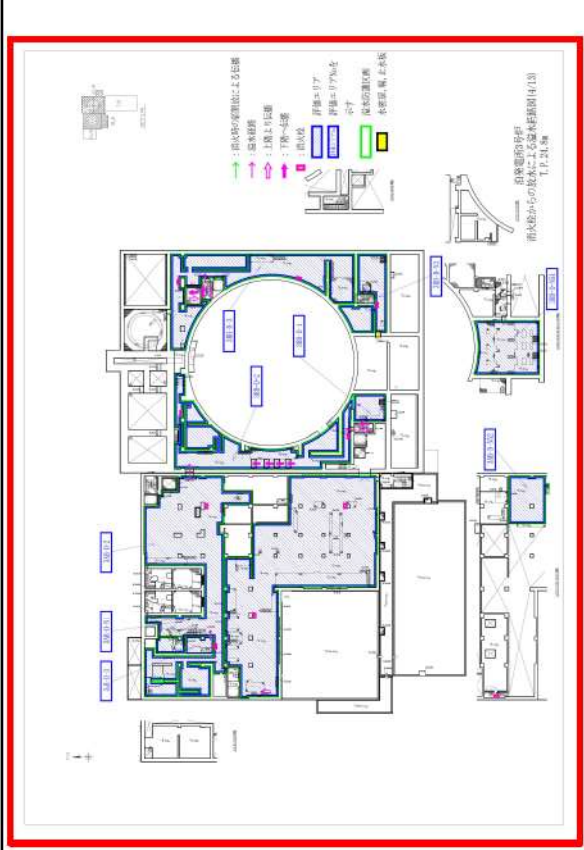
大阪発電所3/4号炉	女川原子力発電所2号炉	泊発電所3号炉	相違理由
			<p>【女川】 <u>記載方針の相違</u> 女川では、地震起因、消火放水、想定破損による溢水によらず防護区画図上に溢水の伝播経路を示しているが、泊は溢水源によって溢水経路及び溢水防護区画を設定している。（大阪と同様）</p> <p>【大阪】 <u>設計方針の相違</u> プラント設計の相違</p>

赤字：設備、運用又は体制の相違（設計方針の相違）
 青字：記載箇所又は記載内容の相違（記載方針の相違）
 緑字：記載表現、設備名称の相違（実質的な相違なし）

大阪発電所3/4号炉	女川原子力発電所2号炉	泊発電所3号炉	相違理由
			<p>【女川】 記載方針の相違 女川では、地震起因、消火放水、想定破損による溢水によらず防護区画図上に溢水の伝播経路を示しているが、泊は溢水源によって溢水経路及び溢水防護区画を設定している。(大阪と同様)</p> <p>【大阪】 設計方針の相違 プラント設計の相違</p>

赤字：設備、運用又は体制の相違（設計方針の相違）
 青字：記載箇所又は記載内容の相違（記載方針の相違）
 緑字：記載表現、設備名称の相違（実質的な相違なし）

大阪発電所3/4号炉	女川原子力発電所2号炉	泊発電所3号炉	相違理由
		<div style="border: 2px solid red; padding: 10px; min-height: 500px;"> <!-- Content of the red-bordered box, which is mostly blank in the image --> </div>	<p>【大阪】 設計方針の相違 プラント設計の相違</p>
<div style="border: 1px solid black; padding: 2px;"> 枠囲みの内容は機密情報に属しますので公開できません。 </div>			

赤字：設備、運用又は体制の相違（設計方針の相違）
 青字：記載箇所又は記載内容の相違（記載方針の相違）
 緑字：記載表現、設備名称の相違（実質的な相違なし）

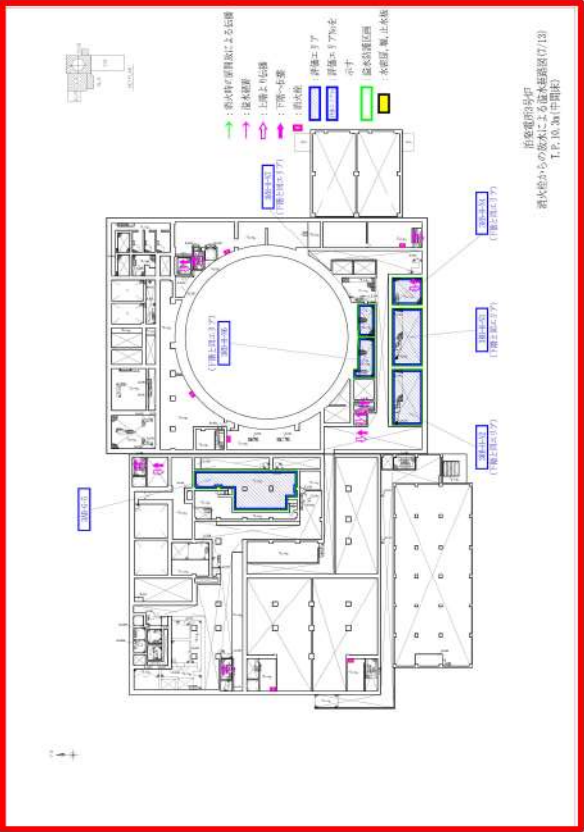
大阪発電所3/4号炉	女川原子力発電所2号炉	泊発電所3号炉	相違理由
			<p>【大阪】 設計方針の相違 プラント設計の相違</p>

赤字：設備、運用又は体制の相違（設計方針の相違）
 青字：記載箇所又は記載内容の相違（記載方針の相違）
 緑字：記載表現、設備名称の相違（実質的な相違なし）

大阪発電所3/4号炉	女川原子力発電所2号炉	泊発電所3号炉	相違理由
		<div style="border: 2px solid red; height: 500px; width: 100%;"></div> <p>□ 枠囲みの内容は機密情報に属しますので公開できません。</p>	<p>【大阪】 設計方針の相違 プラント設計の相違</p>

赤字：設備、運用又は体制の相違（設計方針の相違）
 青字：記載箇所又は記載内容の相違（記載方針の相違）
 緑字：記載表現、設備名称の相違（実質的な相違なし）

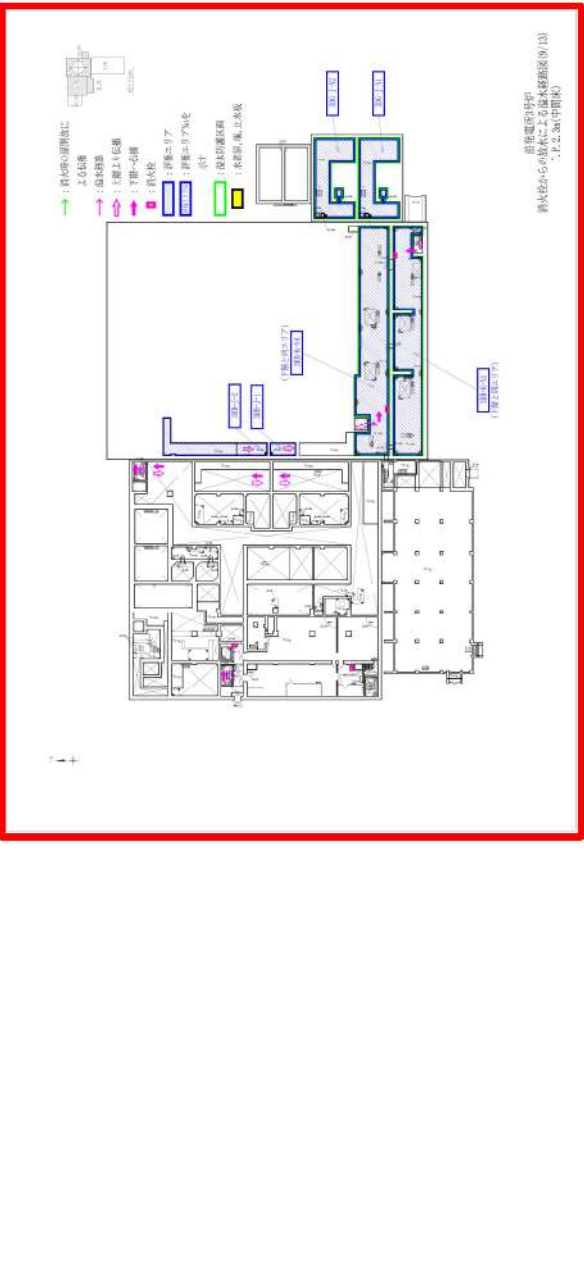
大阪発電所3/4号炉	女川原子力発電所2号炉	泊発電所3号炉	相違理由
			<p>【大阪】 設計方針の相違 プラント設計の相違</p>

赤字：設備、運用又は体制の相違（設計方針の相違）
 青字：記載箇所又は記載内容の相違（記載方針の相違）
 緑字：記載表現、設備名称の相違（実質的な相違なし）

大阪発電所3/4号炉	女川原子力発電所2号炉	泊発電所3号炉	相違理由
			<p>【大阪】 設計方針の相違 プラント設計の相違</p>

赤字：設備、運用又は体制の相違（設計方針の相違）
 青字：記載箇所又は記載内容の相違（記載方針の相違）
 緑字：記載表現、設備名称の相違（実質的な相違なし）

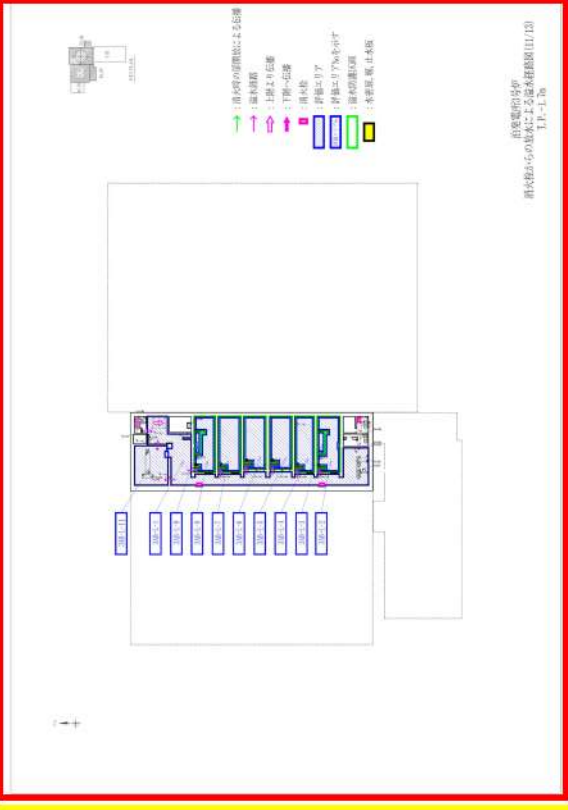
大阪発電所3/4号炉	女川原子力発電所2号炉	泊発電所3号炉	相違理由
			<p>【大阪】 設計方針の相違 プラント設計の相違</p>

赤字：設備、運用又は体制の相違（設計方針の相違）
 青字：記載箇所又は記載内容の相違（記載方針の相違）
 緑字：記載表現、設備名称の相違（実質的な相違なし）

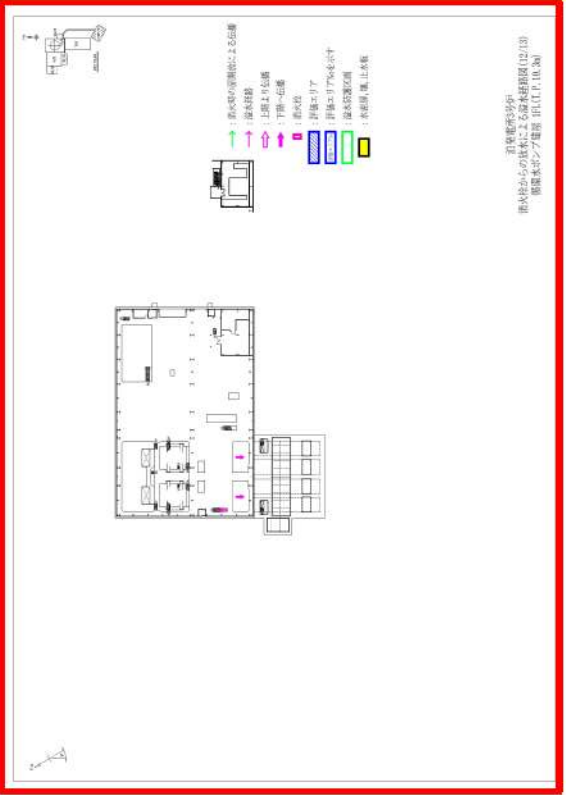
大阪発電所3/4号炉	女川原子力発電所2号炉	泊発電所3号炉	相違理由
		 <p> 赤字：設備、運用又は体制の相違（設計方針の相違） 青字：記載箇所又は記載内容の相違（記載方針の相違） 緑字：記載表現、設備名称の相違（実質的な相違なし） </p> <p> 赤字：設計方針の相違 青字：プラント設計の相違 </p>	<p>【大阪】</p> <p>設計方針の相違 プラント設計の相違</p>

赤字：設備、運用又は体制の相違（設計方針の相違）
 青字：記載箇所又は記載内容の相違（記載方針の相違）
 緑字：記載表現、設備名称の相違（実質的な相違なし）

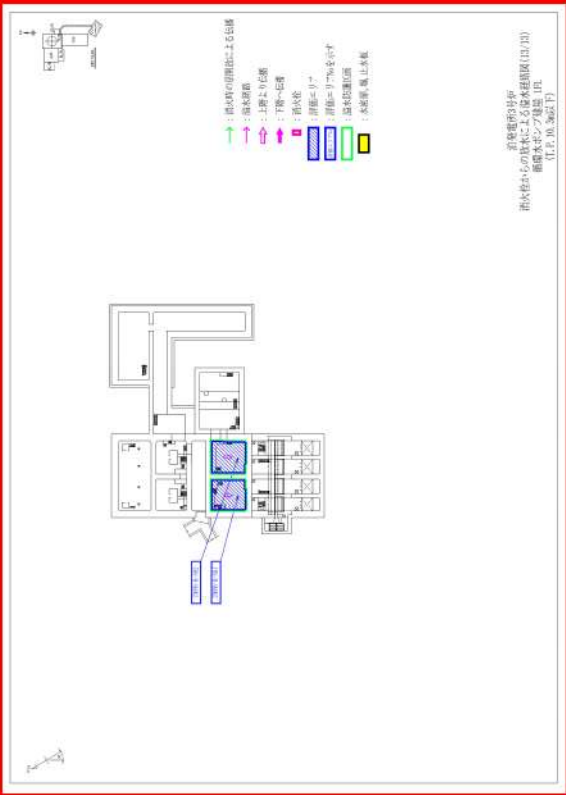
大阪発電所3/4号炉	女川原子力発電所2号炉	泊発電所3号炉	相違理由
			<p>【大阪】 設計方針の相違 プラント設計の相違</p>

赤字：設備、運用又は体制の相違（設計方針の相違）
 青字：記載箇所又は記載内容の相違（記載方針の相違）
 緑字：記載表現、設備名称の相違（実質的な相違なし）

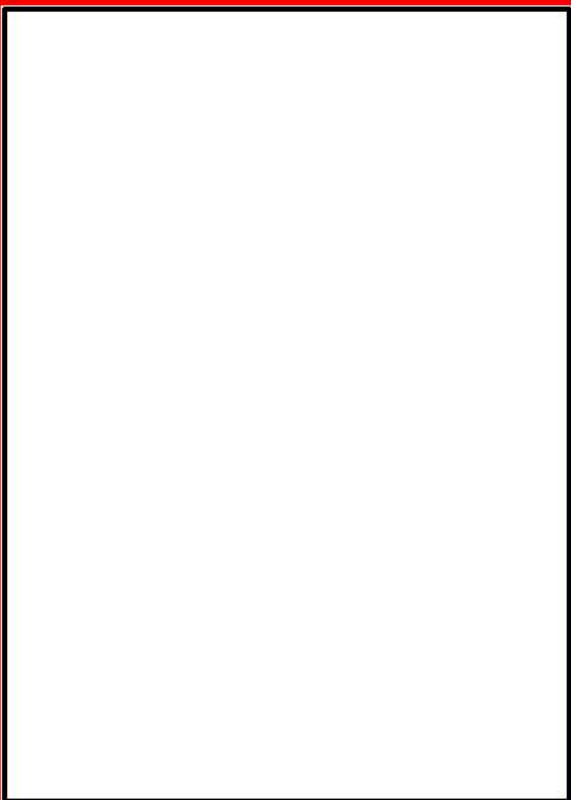
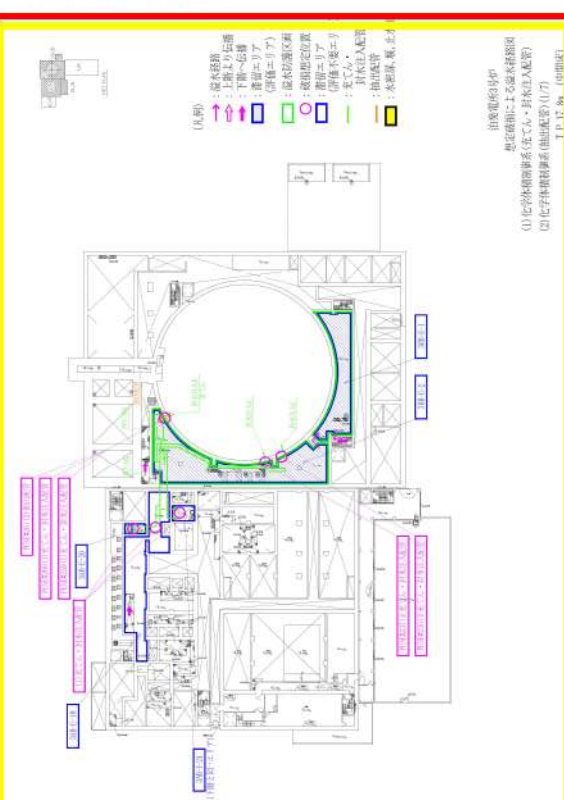
大阪発電所3/4号炉	女川原子力発電所2号炉	泊発電所3号炉	相違理由
	<p>3. 想定破損による溢水経路及び溢水防護区画 (1) 化学体積制御系統</p>	<p>3. 想定破損による溢水経路及び溢水防護区画 (1) 化学体積制御系統</p>  <p>田原電站の守り 想定破損による溢水経路 (1) 化学体積制御系統(主待てん・封水注入配管) (2) 化学体積制御系統(抽出配管)(1/7) T.P.P. No. 1000017</p>	<p>【女川】 記載方針の相違 女川では、地震起因、消火水放水、想定破損による溢水によらず防護区画図上に溢水の伝播経路を示しているが、泊は溢水源によって溢水経路及び溢水防護区画を設定している。(大阪と同様)</p> <p>【大阪】 設計方針の相違 プラント設計の相違</p>
<p>←+ 枠組みの範囲は機密に係る事項ですので公開することはできません。</p>			

赤字：設備、運用又は体制の相違（設計方針の相違）
 青字：記載箇所又は記載内容の相違（記載方針の相違）
 緑字：記載表現、設備名称の相違（実質的な相違なし）

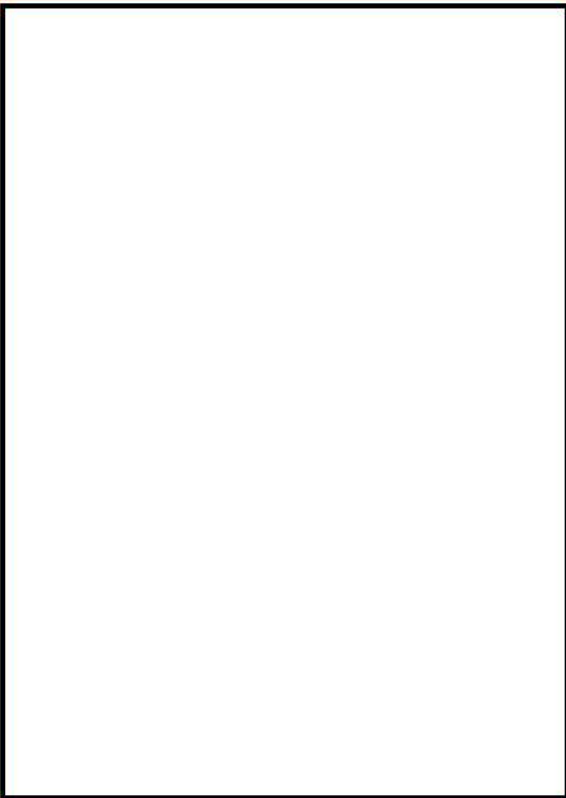
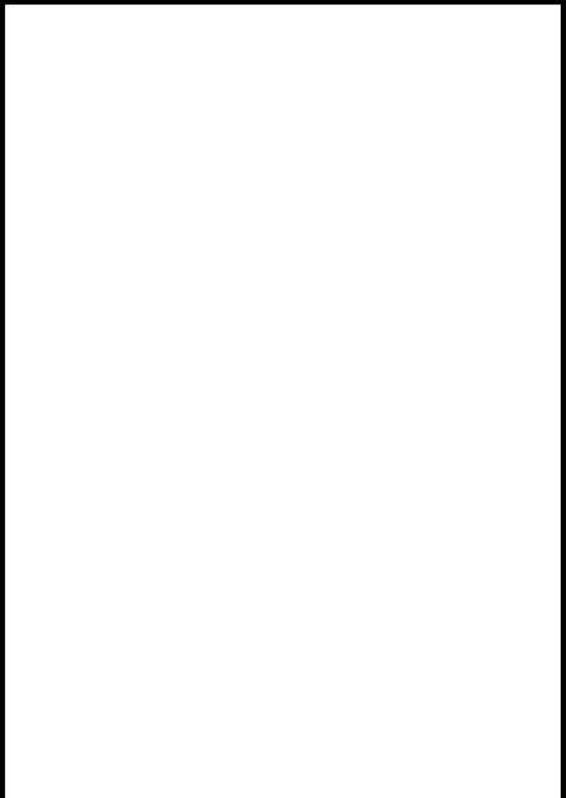
大阪発電所3/4号炉	女川原子力発電所2号炉	泊発電所3号炉	相違理由
			<p>【大阪】 設計方針の相違 プラント設計の相違</p>
<p>※ 枠囲みの範囲は機密に係る事項ですので公開することはできません。</p>		<p>※ 枠囲みの内容は機密情報に属しますので公開できません。</p>	

赤字：設備、運用又は体制の相違（設計方針の相違）
 青字：記載箇所又は記載内容の相違（記載方針の相違）
 緑字：記載表現、設備名称の相違（実質的な相違なし）

大阪発電所3/4号炉	女川原子力発電所2号炉	泊発電所3号炉	相違理由
<div style="border: 2px solid red; height: 500px; width: 100%;"></div>		<div style="border: 2px solid red; height: 500px; width: 100%;"></div>	<p>【大阪】 設計方針の相違 プラント設計の相違</p>
<p>枠囲みの範囲は機密に係る事項ですので公開することはできません。</p>		<p>枠囲みの内容は機密情報に属しますので公開できません。</p>	

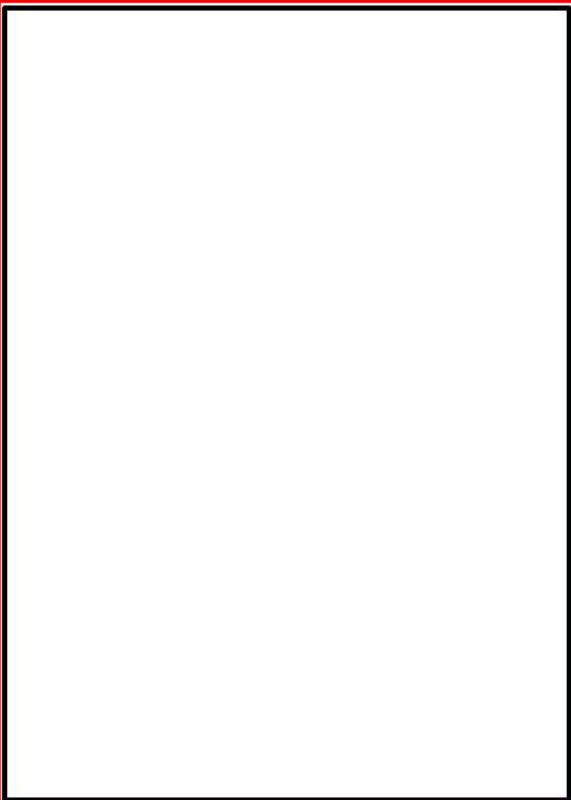
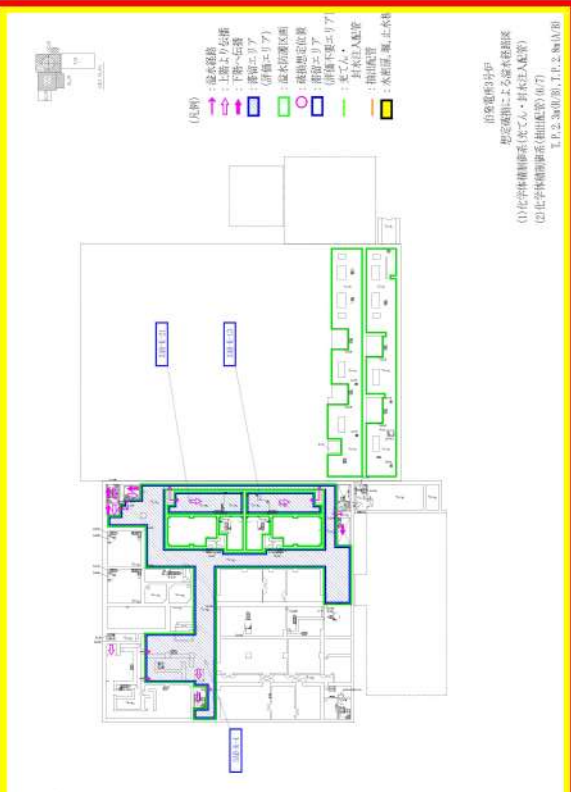

赤字：設備、運用又は体制の相違（設計方針の相違）
 青字：記載箇所又は記載内容の相違（記載方針の相違）
 緑字：記載表現、設備名称の相違（実質的な相違なし）

大阪発電所3/4号炉	女川原子力発電所2号炉	泊発電所3号炉	相違理由
			<p>【大阪】</p> <p>設計方針の相違 プラント設計の相違</p>
<p>←→</p> <p>枠組みの範囲は機密に係る事項ですので公開することはできません。</p>			

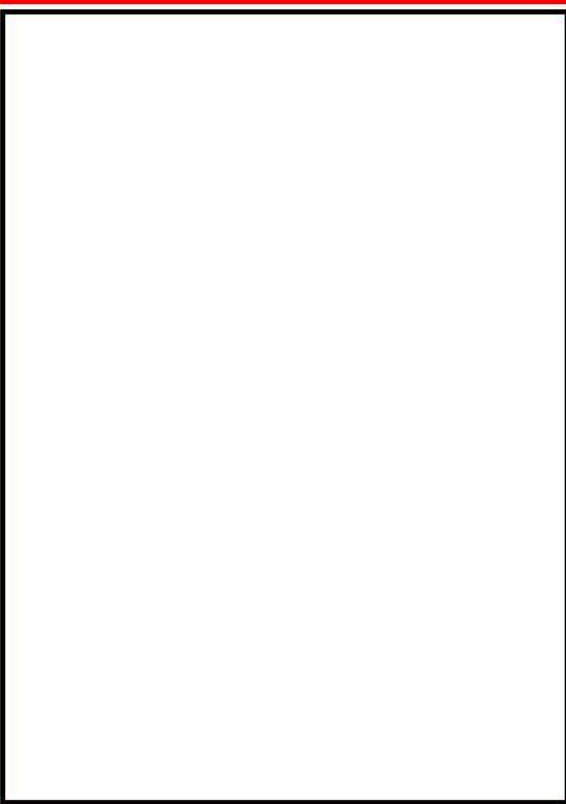
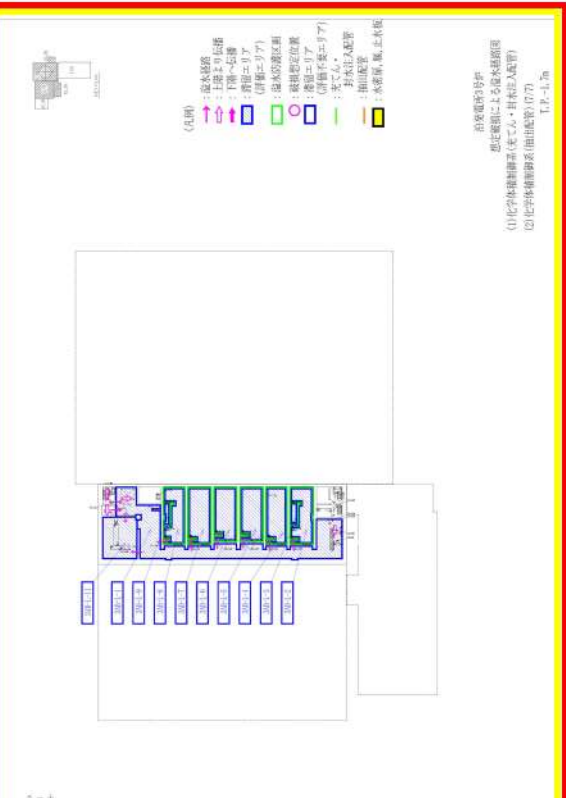
赤字：設備、運用又は体制の相違（設計方針の相違）
 青字：記載箇所又は記載内容の相違（記載方針の相違）
 緑字：記載表現、設備名称の相違（実質的な相違なし）

大阪発電所3/4号炉	女川原子力発電所2号炉	泊発電所3号炉	相違理由
			<p>【大阪】 設計方針の相違 プラント設計の相違</p>
<p>←+ 枠組みの範囲は機密に係る事項ですので公開することはできません。</p>			

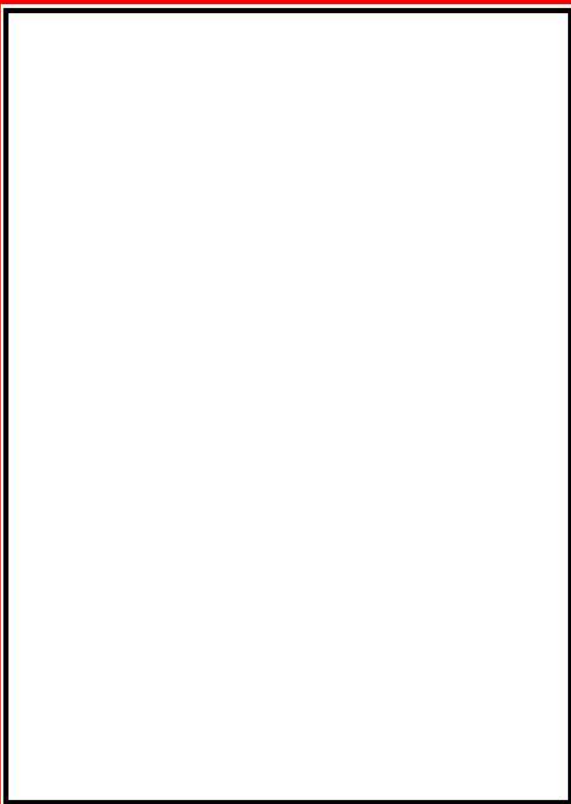
赤字：設備、運用又は体制の相違（設計方針の相違）
 青字：記載箇所又は記載内容の相違（記載方針の相違）
 緑字：記載表現、設備名称の相違（実質的な相違なし）

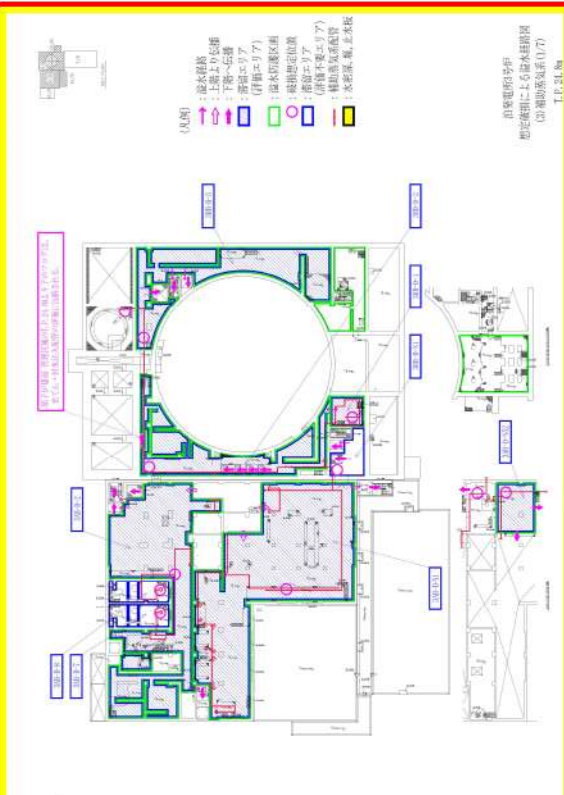

大阪発電所3/4号炉	女川原子力発電所2号炉	泊発電所3号炉	相違理由
		<p>(2) 補助蒸気系統</p>  <p>大阪発電所3号炉 即定範囲による即水相図例 (2) 補助蒸気系統(1/7) T.P. 24.8m</p>	<p>【女川】 記載方針の相違 女川では、地震起因、消火放水水、想定破損による溢水によらず防護区画図上に溢水の伝播経路を示しているが、泊は溢水源によって溢水経路及び溢水防護区画を設定している。(大阪と同様)</p> <p>【大阪】 設計方針の相違 プラント設計の相違</p>
<p>※ 枠組みの範囲は機密に係る事項ですので公開することはできません。</p>			

赤字：設備、運用又は体制の相違（設計方針の相違）
 青字：記載箇所又は記載内容の相違（記載方針の相違）
 緑字：記載表現、設備名称の相違（実質的な相違なし）

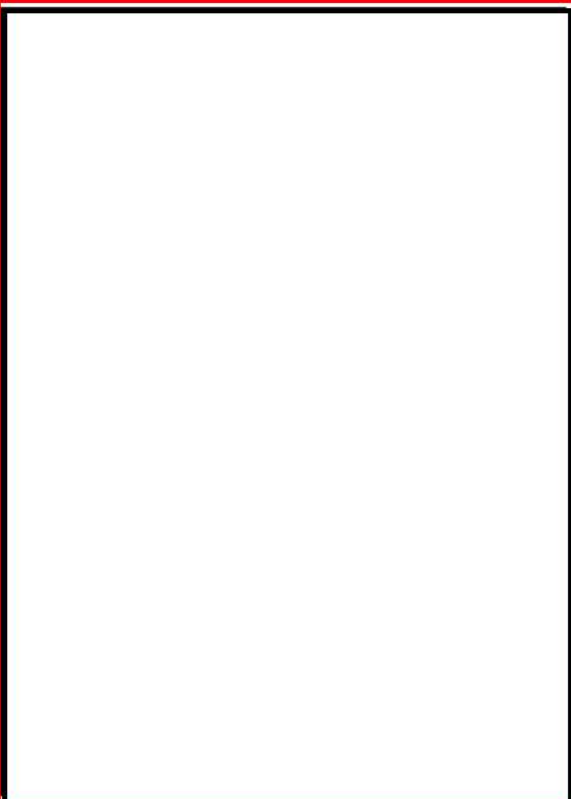
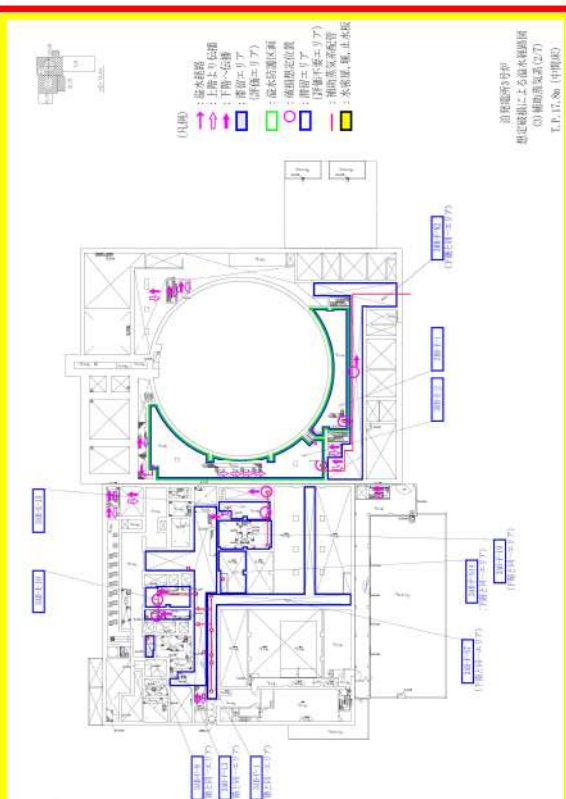
第9条 溢水による損傷の防止等（別添1添付資料10）

大阪発電所3/4号炉	女川原子力発電所2号炉	泊発電所3号炉	相違理由
		 <p>泊発電所3号炉 相違箇所による相違範囲図 (1) 補助送気室(2F) T.P. 11-28a (1000R)</p>	<p>【大阪】 設計方針の相違 プラント設計の相違</p>
<p>冷組みの範囲は機密に係る事項ですので公開することはできません。</p>			

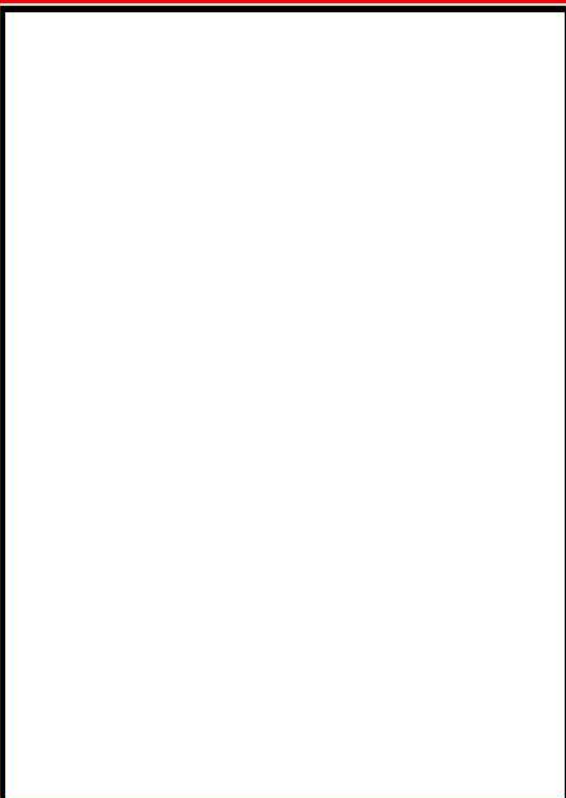
赤字：設備、運用又は体制の相違（設計方針の相違）
 青字：記載箇所又は記載内容の相違（記載方針の相違）
 緑字：記載表現、設備名称の相違（実質的な相違なし）

大阪発電所3/4号炉	女川原子力発電所2号炉	泊発電所3号炉	相違理由
			<p>【大阪】 設計方針の相違 グラント設計の相違</p>
<p>冷温みの範囲は機密に係る事項ですので公開することはできません。</p>		<p>枠囲みの内容は機密情報に属しますので公開できません。</p>	

赤字：設備、運用又は体制の相違（設計方針の相違）
 青字：記載箇所又は記載内容の相違（記載方針の相違）
 緑字：記載表現、設備名称の相違（実質的な相違なし）

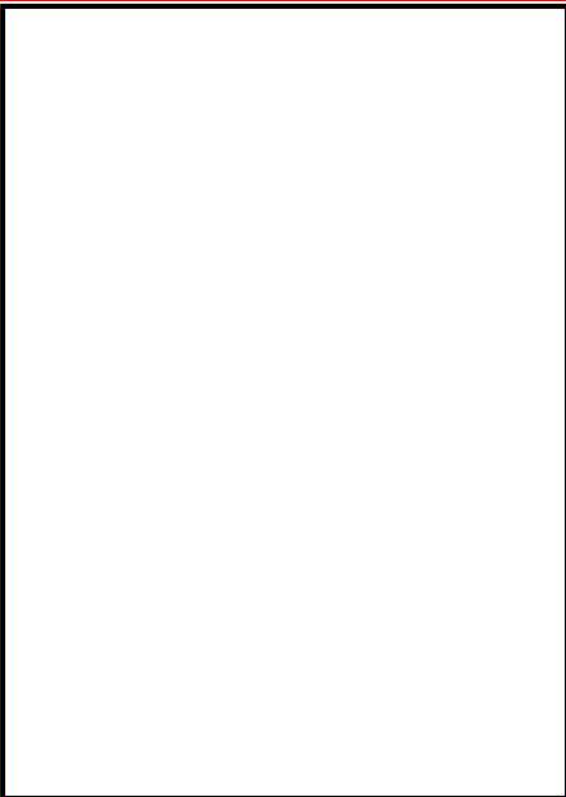
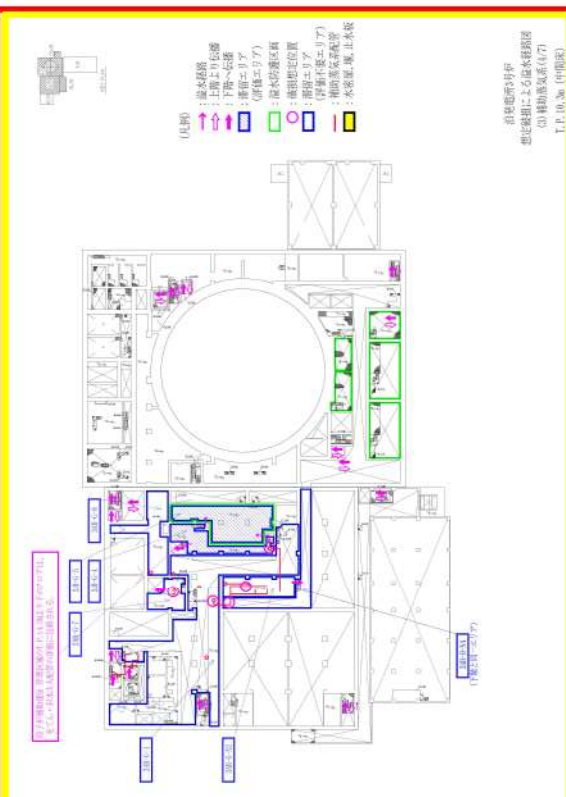
大阪発電所3/4号炉	女川原子力発電所2号炉	泊発電所3号炉	相違理由
		 <p>（凡例）</p> <ul style="list-style-type: none"> 赤字：設備、運用又は体制の相違 青字：記載箇所又は記載内容の相違 緑字：記載表現、設備名称の相違 <p>（注）</p> <ul style="list-style-type: none"> ↑：床下設備 ↓：上層へ伝達 ○：設備エリア □：設備エリア ○：設備設置位置 ○：設備不備エリア ○：補助設備設置 ○：水密区画、止水板 <p>泊発電所3号炉 設計図書による漏水相違図 (3) 補助設備エリア(7) T.P. 10-38 (10/08/02)</p>	<p>【大阪】</p> <p>設計方針の相違 プラント設計の相違</p>
<p>←→</p> <p>枠組みの範囲は機密に係る事項ですので公開することはできません。</p>			

赤字：設備、運用又は体制の相違（設計方針の相違）
 青字：記載箇所又は記載内容の相違（記載方針の相違）
 緑字：記載表現、設備名称の相違（実質的な相違なし）

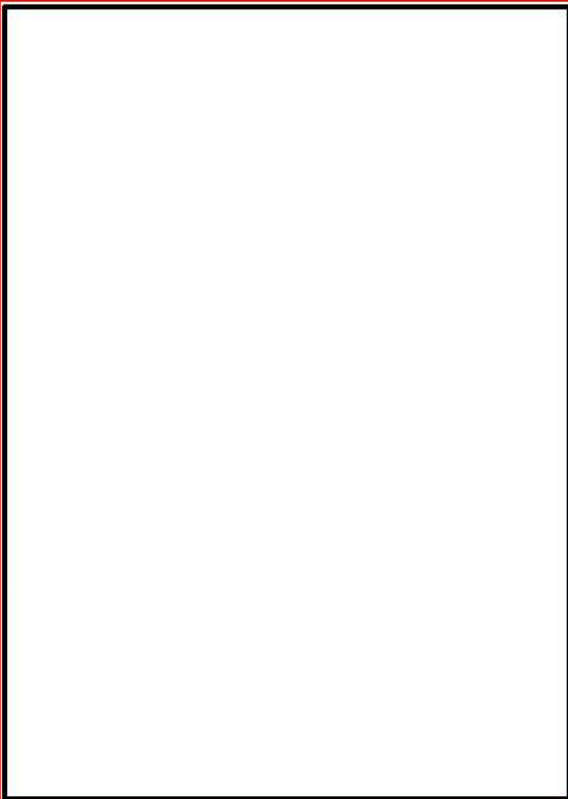
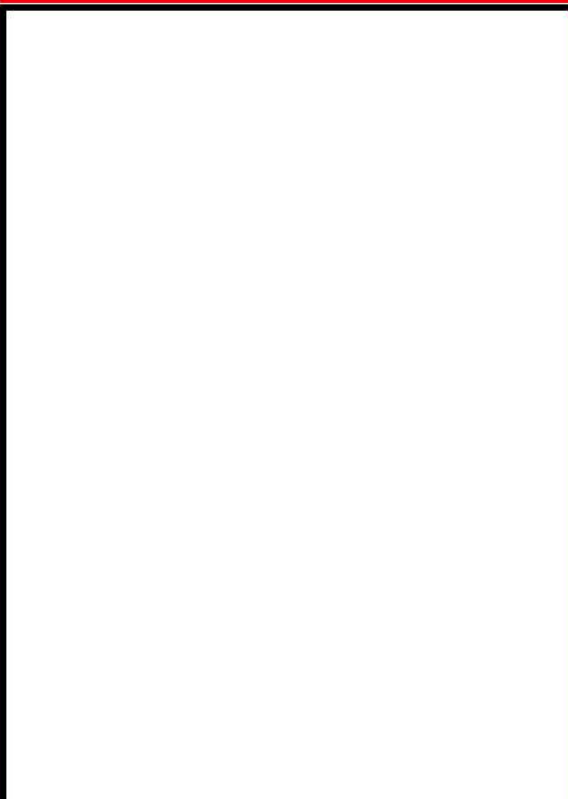
大阪発電所3/4号炉	女川原子力発電所2号炉	泊発電所3号炉	相違理由
			<p>【大阪】 設計方針の相違 プラント設計の相違</p>
<p>←+ 枠組みの範囲は機密に係る事項ですので公開することはできません。</p>		<p>□ 枠組みの内容は機密情報に属しますので公開できません。</p>	

赤字：設備、運用又は体制の相違（設計方針の相違）
 青字：記載箇所又は記載内容の相違（記載方針の相違）
 緑字：記載表現、設備名称の相違（実質的な相違なし）

第9条 溢水による損傷の防止等（別添1 添付資料10）

大阪発電所3/4号炉	女川原子力発電所2号炉	泊発電所3号炉	相違理由
<div data-bbox="114 209 683 1018" style="border: 2px solid red; height: 500px; width: 250px;"></div> <div data-bbox="114 1023 683 1050" style="border: 1px solid black; padding: 2px; font-size: small;"> 管束等の範囲は機器に係る事項ですので公開することはありません。 </div>		<div data-bbox="1292 209 1856 1050" style="border: 2px solid red; padding: 10px;"> <p> 赤：設備、運用又は体制の相違（設計方針の相違） 青：記載箇所又は記載内容の相違（記載方針の相違） 緑：記載表現、設備名称の相違（実質的な相違なし） </p> <p> 市電電炉3号炉 特定範囲による設計相違 (3) 補助送水機(67) T.F.2.2b (中継機) </p> </div>	<p>【大阪】</p> <p>設計方針の相違</p> <p>プラント設計の相違</p>

赤字：設備、運用又は体制の相違（設計方針の相違）
 青字：記載箇所又は記載内容の相違（記載方針の相違）
 緑字：記載表現、設備名称の相違（実質的な相違なし）

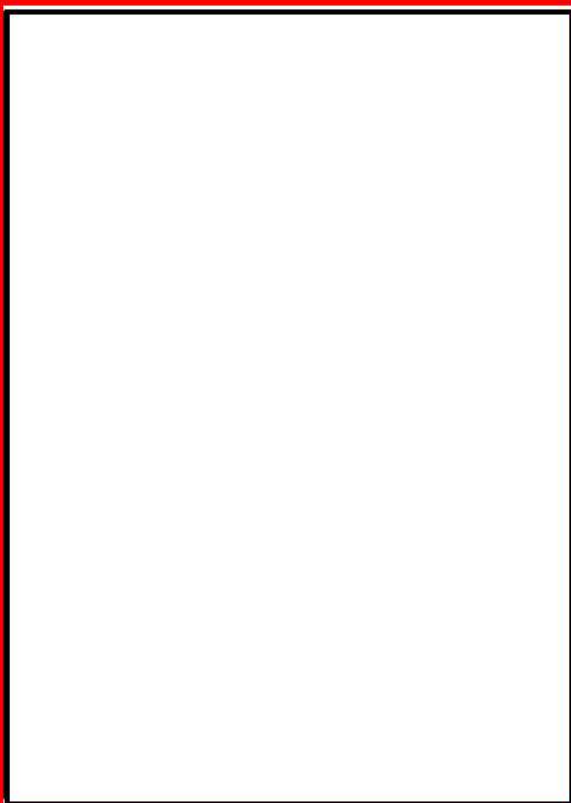
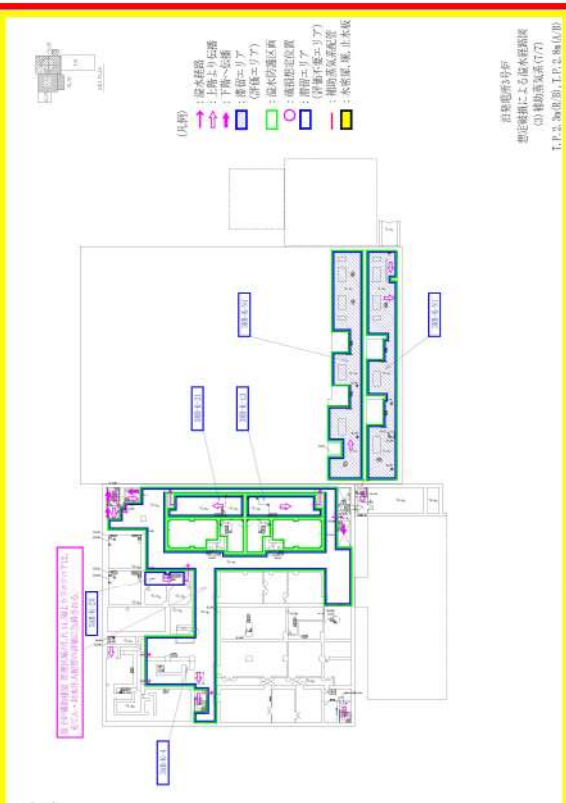
大阪発電所3/4号炉	女川原子力発電所2号炉	泊発電所3号炉	相違理由
			<p>【大阪】</p> <p>設計方針の相違</p> <p>プラント設計の相違</p>
<p>冷組みの範囲は機密に係る事項ですので公開することはできません。</p>			

赤字：設備、運用又は体制の相違（設計方針の相違）
 青字：記載箇所又は記載内容の相違（記載方針の相違）
 緑字：記載表現、設備名称の相違（実質的な相違なし）

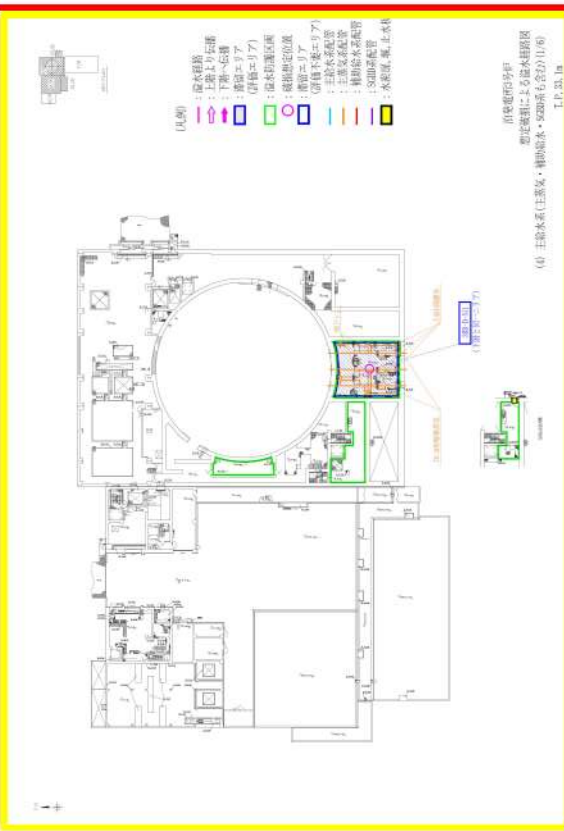
大阪発電所3/4号炉	女川原子力発電所2号炉	泊発電所3号炉	相違理由
<div data-bbox="114 209 683 1018" style="border: 2px solid red; height: 500px;"></div> <div data-bbox="114 1023 683 1043" style="font-size: small;"> 枠組みの範囲は機密に係る事項ですので公開することはできません。 </div>		<p>(3) 主給水系統（主蒸気・補助給水・SGBD系統も含む）</p>  <p>泊発電所3号炉 想定地震による加水相図 (0) 主給水系(主蒸気・補助給水・SGBD系も含む) (1/6) T.P.3.1a</p>	<p>【女川】 記載方針の相違 女川では、地震起因、消火放水、想定破損による溢水によらず防護区画図上に溢水の伝播経路を示しているが、泊は溢水源によって溢水経路及び溢水防護区画を設定している。(大阪と同様)</p> <p>【大阪】 設計方針の相違 プラント設計の相違</p>

赤字：設備、運用又は体制の相違（設計方針の相違）
 青字：記載箇所又は記載内容の相違（記載方針の相違）
 緑字：記載表現、設備名称の相違（実質的な相違なし）

第9条 溢水による損傷の防止等（別添1 添付資料10）

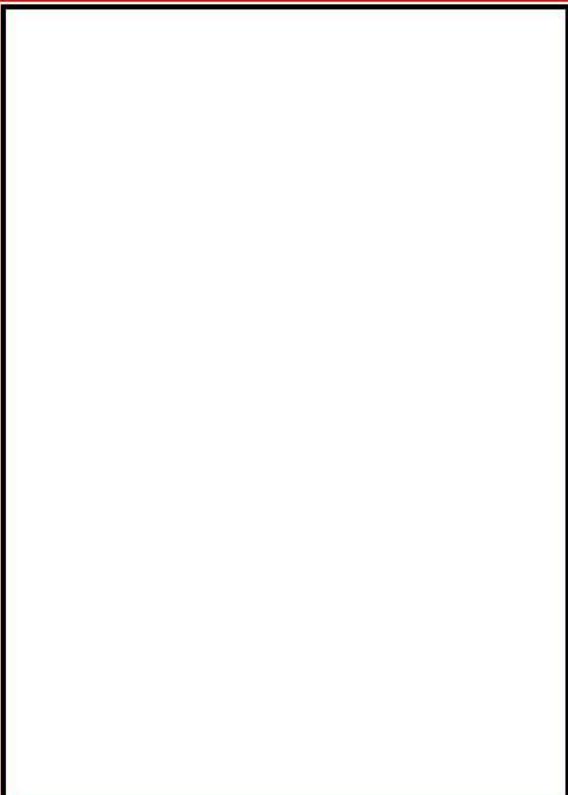
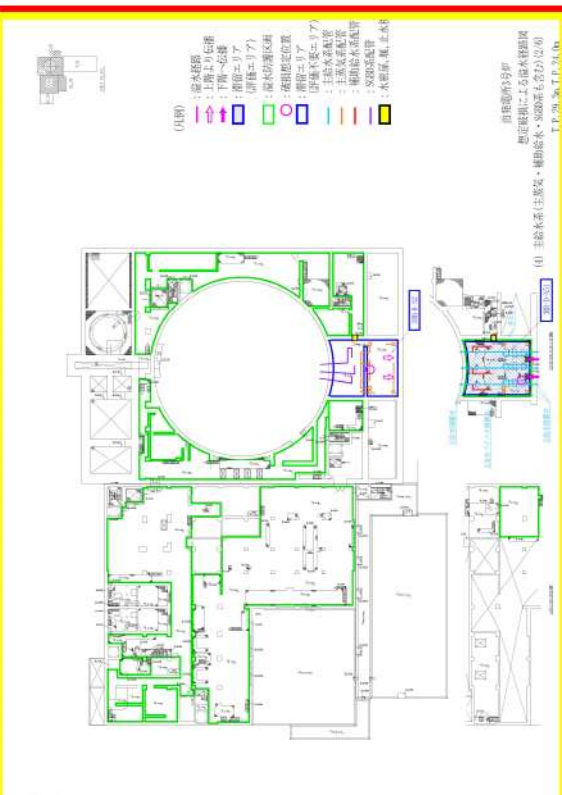
大阪発電所3/4号炉	女川原子力発電所2号炉	泊発電所3号炉	相違理由
			<p>【大阪】 設計方針の相違 プラント設計の相違</p>
<p>冷卻みの範囲は機密に係る事項ですので公開することはできません。</p>			

赤字：設備、運用又は体制の相違（設計方針の相違）
 青字：記載箇所又は記載内容の相違（記載方針の相違）
 緑字：記載表現、設備名称の相違（実質的な相違なし）

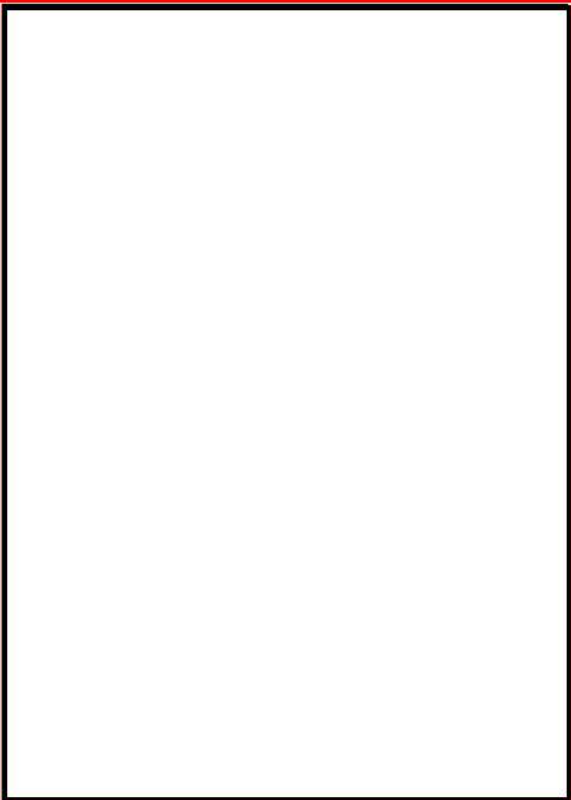
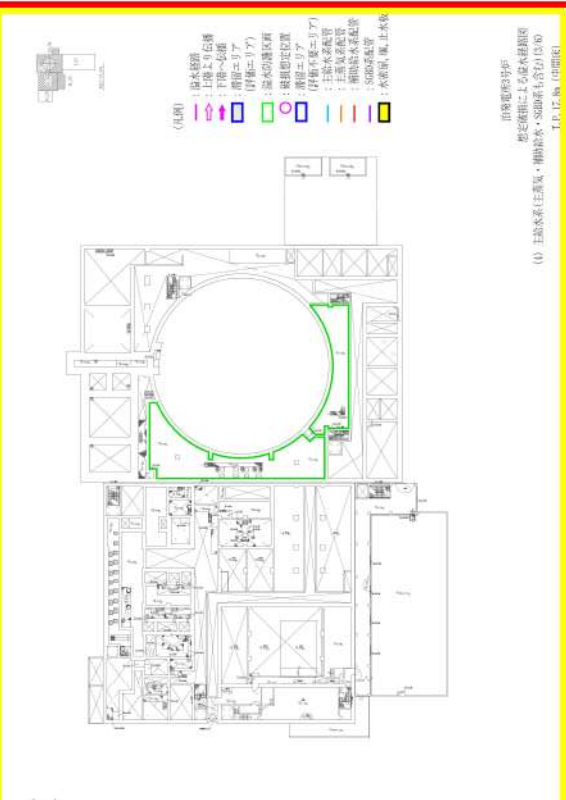
大阪発電所3/4号炉	女川原子力発電所2号炉	泊発電所3号炉	相違理由
		 <p> 泊発電所3号炉 設計範囲による基本経路図 (0) 主熱水系(主蒸気・補助蒸気・SDB系も含む) (DB) T.1.1. No. 10 (0101E) </p>	<p>【大阪】</p> <p>設計方針の相違 プラント設計の相違</p>
<p>← 中</p> <p>枠組みの範囲は機密に係る事項ですので公開することはできません。</p>			

赤字：設備、運用又は体制の相違（設計方針の相違）
 青字：記載箇所又は記載内容の相違（記載方針の相違）
 緑字：記載表現、設備名称の相違（実質的な相違なし）

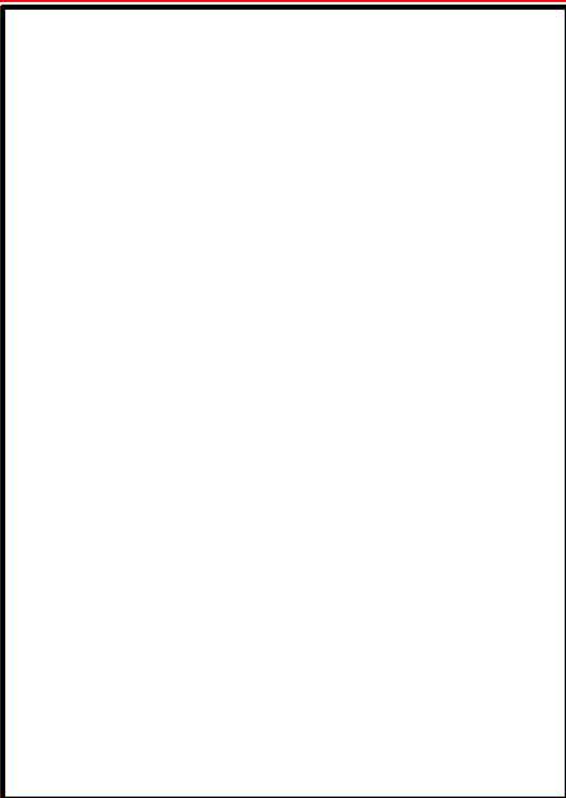
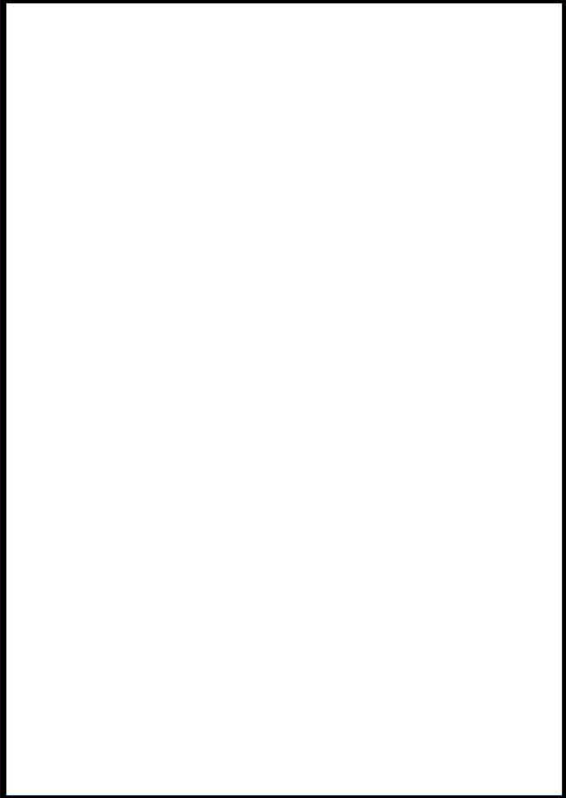
大阪発電所3/4号炉	女川原子力発電所2号炉	泊発電所3号炉	相違理由
			<p>【大阪】 設計方針の相違 プラント設計の相違</p>
<p>← 枠囲みの範囲は機密に係る事項ですので公開することはできません。</p>		<p>← 枠囲みの内容は機密情報に属しますので公開できません。</p>	

赤字：設備、運用又は体制の相違（設計方針の相違）
 青字：記載箇所又は記載内容の相違（記載方針の相違）
 緑字：記載表現、設備名称の相違（実質的な相違なし）

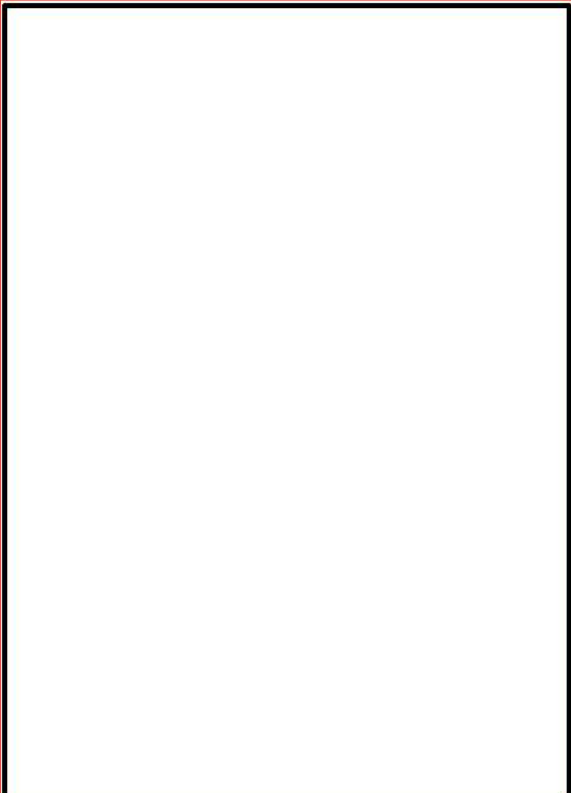
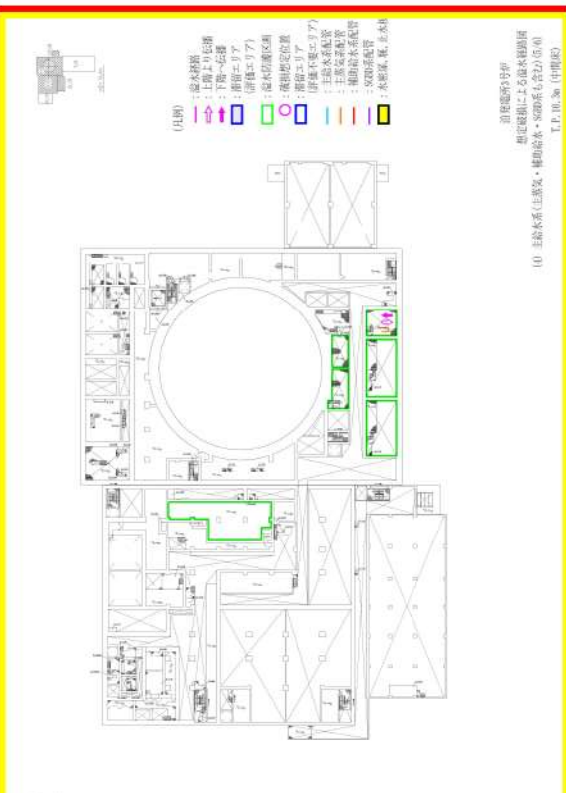
大阪発電所3/4号炉	女川原子力発電所2号炉	泊発電所3号炉	相違理由
		 <p>泊発電所3号炉 相違箇所による図本相違箇所 (0) 主給水系統 (左側)・燃料貯蔵水・SS005等 (右側) T.P. 00.30 (100%)</p>	<p>【大阪】 設計方針の相違 プラント設計の相違</p>
<p>枠組みの範囲は機密に係る事項ですので公開することはできません。</p>			

赤字：設備、運用又は体制の相違（設計方針の相違）
 青字：記載箇所又は記載内容の相違（記載方針の相違）
 緑字：記載表現、設備名称の相違（実質的な相違なし）

大阪発電所3/4号炉	女川原子力発電所2号炉	泊発電所3号炉	相違理由
<div style="border: 2px solid red; height: 500px; width: 100%;"></div>		<div style="border: 2px solid red; height: 500px; width: 100%;"></div>	<p>【大阪】 設計方針の相違 プラント設計の相違</p>
<p>※ 枠囲みの範囲は機密に係る事項ですので公開することはできません。</p>		<p>※ 枠囲みの内容は機密情報に属しますので公開できません。</p>	

赤字：設備、運用又は体制の相違（設計方針の相違）
 青字：記載箇所又は記載内容の相違（記載方針の相違）
 緑字：記載表現、設備名称の相違（実質的な相違なし）

大阪発電所3/4号炉	女川原子力発電所2号炉	泊発電所3号炉	相違理由
<div style="border: 2px solid red; height: 450px; width: 100%;"></div> <div style="border: 1px solid black; padding: 2px; margin-top: 5px;"> <small>特組みの範囲は機密に係る事項ですので公開することはできません。</small> </div>			<p>【大阪】 設計方針の相違 プラント設計の相違</p>

赤字：設備、運用又は体制の相違（設計方針の相違）
 青字：記載箇所又は記載内容の相違（記載方針の相違）
 緑字：記載表現、設備名称の相違（実質的な相違なし）

大阪発電所3/4号炉	女川原子力発電所2号炉	泊発電所3号炉	相違理由
<div style="border: 2px solid red; height: 500px; width: 100%;"></div>			<p>【大阪】</p> <p>設計方針の相違</p> <p>プラント設計の相違</p>
<p>※中</p>	<p>枠組みの範囲は機密に係る事項ですので公開することはできません。</p>		

赤字：設備、運用又は体制の相違（設計方針の相違）
 青字：記載箇所又は記載内容の相違（記載方針の相違）
 緑字：記載表現、設備名称の相違（実質的な相違なし）

第9条 溢水による損傷の防止等（別添1 添付資料10）

大阪発電所3/4号炉	女川原子力発電所2号炉	泊発電所3号炉	相違理由
<div data-bbox="114 212 683 1018" style="border: 2px solid red; height: 500px; width: 250px;"></div> <div data-bbox="114 1023 683 1043" style="border: 1px solid black; padding: 2px;"> 1-5-4 冷風機の範囲は機器に係る事項であり、20開することはありません。 </div>			<p>【大阪】</p> <p>設計方針の相違</p> <p>プラント設計の相違</p>

赤字：設備、運用又は体制の相違（設計方針の相違）
 青字：記載箇所又は記載内容の相違（記載方針の相違）
 緑字：記載表現、設備名称の相違（実質的な相違なし）

第9条 溢水による損傷の防止等（別添1添付資料10）

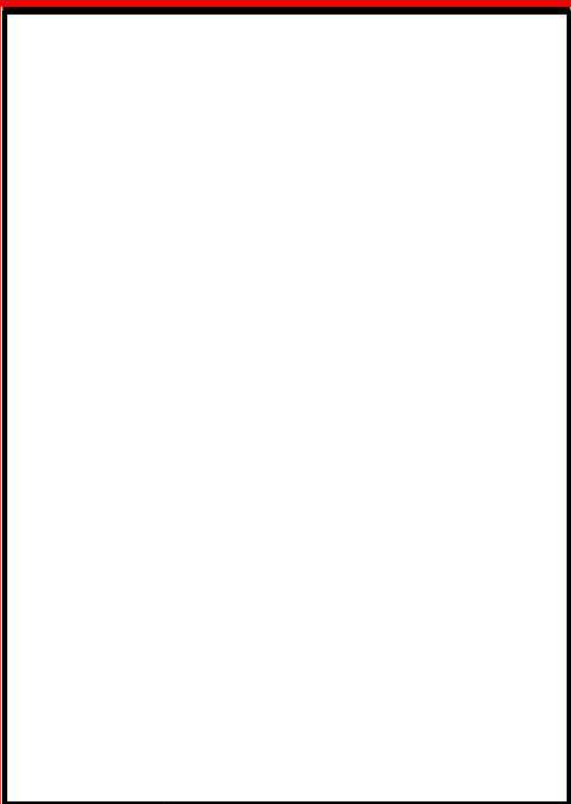
大阪発電所3/4号炉	女川原子力発電所2号炉	泊発電所3号炉	相違理由
			<p>【大阪】 設計方針の相違 プラント設計の相違</p>
<p>図10-51 炉心及び炉内は機器に依る事項であり、25開示することはありません。</p>			

赤字：設備、運用又は体制の相違（設計方針の相違）
 青字：記載箇所又は記載内容の相違（記載方針の相違）
 緑字：記載表現、設備名称の相違（実質的な相違なし）

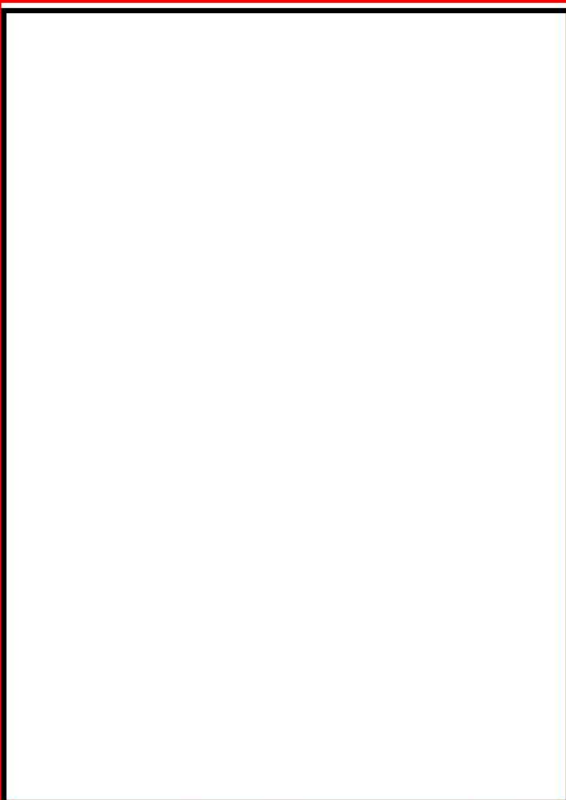
大阪発電所3/4号炉	女川原子力発電所2号炉	泊発電所3号炉	相違理由
			<p>【大阪】 設計方針の相違 プラント設計の相違</p>
<p>※ 枠組みの範囲は機密に係る事項ですので公開することはできません。</p>			

赤字：設備、運用又は体制の相違（設計方針の相違）
 青字：記載箇所又は記載内容の相違（記載方針の相違）
 緑字：記載表現、設備名称の相違（実質的な相違なし）

第9条 溢水による損傷の防止等（別添1添付資料10）

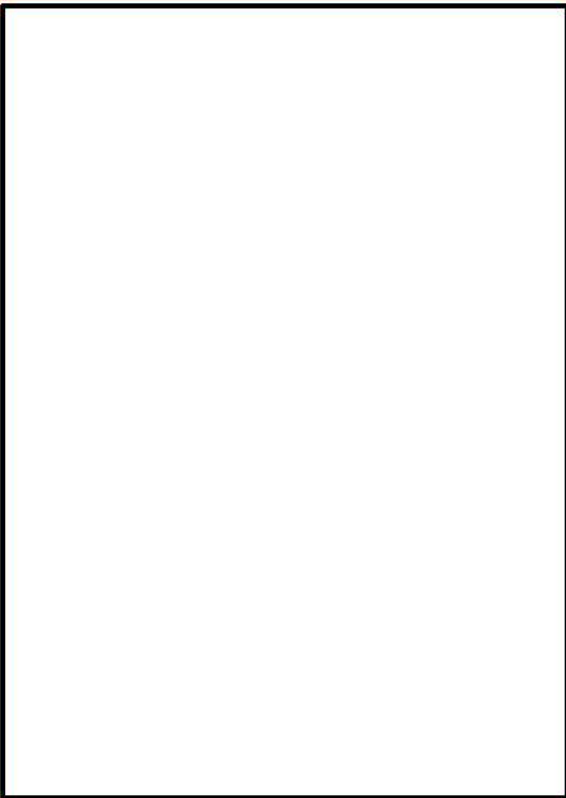
大阪発電所3/4号炉	女川原子力発電所2号炉	泊発電所3号炉	相違理由
			<p>【大阪】 設計方針の相違 プラント設計の相違</p>
<p>※ 枠組みの範囲は機密に係る事項ですので公開することはできません。</p>			

赤字：設備、運用又は体制の相違（設計方針の相違）
 青字：記載箇所又は記載内容の相違（記載方針の相違）
 緑字：記載表現、設備名称の相違（実質的な相違なし）

第9条 溢水による損傷の防止等（別添1添付資料10）

大阪発電所3/4号炉	女川原子力発電所2号炉	泊発電所3号炉	相違理由
<div style="border: 2px solid red; height: 500px; width: 100%;"></div>			<p>【大阪】 設計方針の相違 プラント設計の相違</p>
<p>※ 枠組みの範囲は機密に係る事項ですので公開することはできません。</p>			

赤字：設備、運用又は体制の相違（設計方針の相違）
 青字：記載箇所又は記載内容の相違（記載方針の相違）
 緑字：記載表現、設備名称の相違（実質的な相違なし）

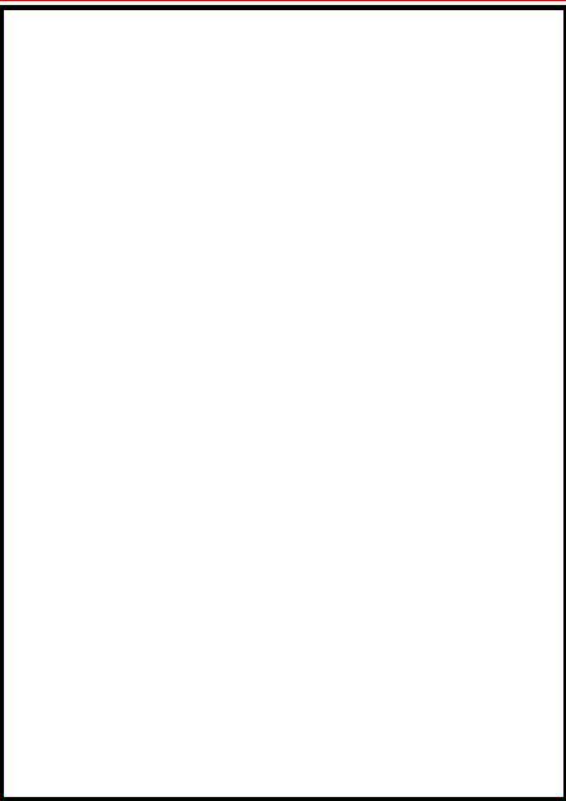
大阪発電所3/4号炉	女川原子力発電所2号炉	泊発電所3号炉	相違理由
			<p>【大阪】 設計方針の相違 プラント設計の相違</p>
<p>※ 枠組みの範囲は機密に係る事項ですので公開することはできません。</p>			

赤字：設備、運用又は体制の相違（設計方針の相違）
 青字：記載箇所又は記載内容の相違（記載方針の相違）
 緑字：記載表現、設備名称の相違（実質的な相違なし）

第9条 溢水による損傷の防止等（別添1添付資料10）

大阪発電所3/4号炉	女川原子力発電所2号炉	泊発電所3号炉	相違理由
<div style="border: 2px solid red; height: 500px; width: 100%;"></div>			<p>【大阪】 設計方針の相違 プラント設計の相違</p>
<p>※ 枠組みの範囲は横断に係る事項ですので公開することはできません。</p>			

赤字：設備、運用又は体制の相違（設計方針の相違）
 青字：記載箇所又は記載内容の相違（記載方針の相違）
 緑字：記載表現、設備名称の相違（実質的な相違なし）

大阪発電所3/4号炉	女川原子力発電所2号炉	泊発電所3号炉	相違理由
<p>【大阪3/4号炉】 まとめ資料p.2-9-別1-60より抜粋 2.3 溢水防護区画及び溢水経路の設定 (3) 溢水伝播 上層階の溢水は階段あるいは機器ハッチを経由して下層階へ伝播する。下層階への伝播については、下層階における溢水の伝播先を特定し、上層階からの溢水量全量が流入するものとする。</p>	<p>【女川2号炉】 まとめ資料p.9条-別添1-4-3より抜粋 4. 3 溢水経路の設定 (3) 溢水伝播 上層階の溢水は階段あるいは開口部を経由して下層階へ伝播する。下層階への伝播については、下層階における溢水の伝播先を特定し、上層階からの溢水量全量が流入するものとする。</p>	<p style="text-align: right;">別紙1</p> <p>機器ハッチから溢水が流下しない場合の影響について</p> <p>1. はじめに 機器ハッチが床面にある区画の没水影響評価では、機器ハッチからの流下に期待せず、溢水全量が区画に貯留される条件で溢水水位を算出している。また、機器ハッチの下層階にある区画の没水影響評価では、下層階における溢水の伝播先を特定し、上層階からの溢水量全量が下層階へ流入するものとしている。 ここでは、定期事業者検査作業に伴う機器ハッチの状態変更等により、一時的に上層階から下層階へ溢水が伝播しない機器ハッチが生じた場合を想定しても、溢水防護対象設備が必要な安全機能を損なわないことを確認する。</p> <p>2. 確認結果 下層階への伝播経路には、機器ハッチの他、階段室やエレベータもあり、定期事業者検査作業等で機器ハッチから溢水が流下しない状況になった場合でも、上層階からの溢水が流下する区画への流下経路が複数存在しているケースでは、没水影響評価で想定する溢水伝播経路は変わらない。 また、上層階からの溢水流下経路が機器ハッチ1箇所の区画については、流下経路が閉塞した場合に下層階へ溢水伝播しないため、下層階の没水影響評価で考慮すべき溢水量が無くなる、若しくは下層階の溢水源から生じる溢水量のみに減少することにより、溢水水位は下層階への伝播を想定した場合よりも低くなるため、溢水防護対象設備が没水により必要な安全機能を損なうことはない。</p> <div style="text-align: center;"> <p>図1. 流下経路の例</p> </div>	<p>【女川・大阪】 記載方針の相違</p> <p>・女川と大阪も、上層階からの溢水伝播において、下層階における溢水の伝播先を特定し、上層階からの溢水量全量が流入するものとしている点は泊と同じである。 ・泊では、伝播経路として特定した溢水の流下経路のうち、機器ハッチが定期事業者検査作業等によって溢水が伝播しない状況になった場合の影響を確認している。</p>

赤字：設備、運用又は体制の相違（設計方針の相違）
 青字：記載箇所又は記載内容の相違（記載方針の相違）
 緑字：記載表現、設備名称の相違（実質的な相違なし）

大阪発電所3/4号炉	女川原子力発電所2号炉	泊発電所3号炉	相違理由																																																																													
	<p style="text-align: right;">添付資料 12</p> <p>開口部等からの流出流量の評価</p> <p>1. はじめに 没水高さが高くなるようなエリアについて、扉開運用などにより流下開口を設置し、ある没水高さ以上とならないよう対策を実施している。ここでは、流下開口を設置しているエリアについて、流下開口からの流出流量が想定破損による系統流量を上回ることを確認する。</p> <p>2. 流下開口設置エリア 流下開口が設置してある区画を、表1に示す。</p> <p style="text-align: center;">表1 流下開口設置区画(1/2)</p> <table border="1" data-bbox="696 997 1272 1493"> <thead> <tr> <th>建屋</th> <th>区画番号</th> <th>流下開口</th> <th>数量</th> </tr> </thead> <tbody> <tr><td rowspan="20">原子炉建屋原子炉棟</td><td>R-1F-5</td><td>扉（開運用）</td><td>2</td></tr> <tr><td>R-B1F-1</td><td>扉（開運用）</td><td>2</td></tr> <tr><td>R-B2F-1</td><td>扉（開運用）</td><td>2</td></tr> <tr><td>R-3F-1</td><td>ハッチ（開運用）</td><td>1</td></tr> <tr><td>R-2F-3</td><td>ハッチ（大物搬入口）</td><td>1</td></tr> <tr><td>R-B2F-2</td><td>ハッチ（グレーチング）</td><td>1</td></tr> <tr><td>R-B2F-3</td><td>ハッチ（グレーチング）</td><td>1</td></tr> <tr><td>R-M2F-1</td><td>吹抜</td><td>1</td></tr> <tr><td>R-M2F-2</td><td>吹抜</td><td>1</td></tr> <tr><td>R-M2F-3</td><td>吹抜</td><td>1</td></tr> <tr><td>R-M2F-5</td><td>吹抜</td><td>1</td></tr> <tr><td>R-M2F-6</td><td>吹抜</td><td>1</td></tr> <tr><td>R-1F-8</td><td>吹抜</td><td>1</td></tr> <tr><td>R-1F-9</td><td>吹抜</td><td>1</td></tr> <tr><td>R-M1F-1</td><td>吹抜</td><td>1</td></tr> <tr><td>R-M1F-2</td><td>吹抜</td><td>1</td></tr> <tr><td>R-M1F-3</td><td>吹抜</td><td>1</td></tr> <tr><td>R-M1F-4</td><td>吹抜</td><td>1</td></tr> <tr><td>R-B2F-7</td><td>吹抜</td><td>1</td></tr> </tbody> </table>	建屋	区画番号	流下開口	数量	原子炉建屋原子炉棟	R-1F-5	扉（開運用）	2	R-B1F-1	扉（開運用）	2	R-B2F-1	扉（開運用）	2	R-3F-1	ハッチ（開運用）	1	R-2F-3	ハッチ（大物搬入口）	1	R-B2F-2	ハッチ（グレーチング）	1	R-B2F-3	ハッチ（グレーチング）	1	R-M2F-1	吹抜	1	R-M2F-2	吹抜	1	R-M2F-3	吹抜	1	R-M2F-5	吹抜	1	R-M2F-6	吹抜	1	R-1F-8	吹抜	1	R-1F-9	吹抜	1	R-M1F-1	吹抜	1	R-M1F-2	吹抜	1	R-M1F-3	吹抜	1	R-M1F-4	吹抜	1	R-B2F-7	吹抜	1	<p style="text-align: right;">添付資料 11</p> <p>開口部等からの流出流量の評価</p> <p>1. はじめに 没水高さが高くなるようなエリアについて、床開口部により流下開口を設置し、ある没水高さ以上としないよう対策を実施している。ここでは、流下開口を設置しているエリアについて、流下開口からの流出流量が想定破損による系統流量を上回ることを確認する。</p> <p>2. 流下開口設置エリア 流下開口が設置してある区画を、表1に示す。</p> <p style="text-align: center;">表1 流下開口設置区画</p> <table border="1" data-bbox="1279 997 1861 1109"> <thead> <tr> <th>建屋</th> <th>区画番号</th> <th>流下開口</th> <th>数量</th> </tr> </thead> <tbody> <tr><td>原子炉建屋</td><td>3RB-D-N51</td><td>グレーチング</td><td>2</td></tr> <tr><td rowspan="2">原子炉補助建屋</td><td>3AB-H-2</td><td>吹抜</td><td>1</td></tr> <tr><td>3AB-H-9</td><td>吹抜</td><td>1</td></tr> </tbody> </table>	建屋	区画番号	流下開口	数量	原子炉建屋	3RB-D-N51	グレーチング	2	原子炉補助建屋	3AB-H-2	吹抜	1	3AB-H-9	吹抜	1	<p>【大阪】 記載方針の相違 女川審査実績の反映</p> <p>【女川】 記載表現の相違 設計方針の相違 泊は扉から溢水が流出し、没水水位を抑制することに期待していない。（先行PWRにおいても同様であることを先行PWRのまとめ資料に記載がないことをもって確認している。）</p> <p>【女川】 記載表現の相違 設計方針の相違 ・建屋名称、区画番号の相違。 ・泊は開運用の扉から溢水が流出し、没水水位を抑制することに期待していない。（先行PWRにおいても同様であることを先行PWRのまとめ資料に記載がないことをもって確認している。）</p>
建屋	区画番号	流下開口	数量																																																																													
原子炉建屋原子炉棟	R-1F-5	扉（開運用）	2																																																																													
	R-B1F-1	扉（開運用）	2																																																																													
	R-B2F-1	扉（開運用）	2																																																																													
	R-3F-1	ハッチ（開運用）	1																																																																													
	R-2F-3	ハッチ（大物搬入口）	1																																																																													
	R-B2F-2	ハッチ（グレーチング）	1																																																																													
	R-B2F-3	ハッチ（グレーチング）	1																																																																													
	R-M2F-1	吹抜	1																																																																													
	R-M2F-2	吹抜	1																																																																													
	R-M2F-3	吹抜	1																																																																													
	R-M2F-5	吹抜	1																																																																													
	R-M2F-6	吹抜	1																																																																													
	R-1F-8	吹抜	1																																																																													
	R-1F-9	吹抜	1																																																																													
	R-M1F-1	吹抜	1																																																																													
	R-M1F-2	吹抜	1																																																																													
	R-M1F-3	吹抜	1																																																																													
	R-M1F-4	吹抜	1																																																																													
	R-B2F-7	吹抜	1																																																																													
	建屋	区画番号	流下開口	数量																																																																												
原子炉建屋	3RB-D-N51	グレーチング	2																																																																													
原子炉補助建屋	3AB-H-2	吹抜	1																																																																													
	3AB-H-9	吹抜	1																																																																													

赤字：設備、運用又は体制の相違（設計方針の相違）
 青字：記載箇所又は記載内容の相違（記載方針の相違）
 緑字：記載表現、設備名称の相違（実質的な相違なし）

大阪発電所3/4号炉	女川原子力発電所2号炉	泊発電所3号炉	相違理由																																																																															
	<p style="text-align: center;">表1 流下開口設置区画(2/2)</p> <table border="1" style="width: 100%; border-collapse: collapse;"> <thead> <tr> <th style="width: 20%;">建屋</th> <th style="width: 20%;">区画番号</th> <th style="width: 40%;">流下開口</th> <th style="width: 20%;">数量</th> </tr> </thead> <tbody> <tr><td rowspan="14">原子炉建屋付属棟</td><td>R-2F-5</td><td>扉（開運用）</td><td>1</td></tr> <tr><td>R-2F-7</td><td>扉（開運用）</td><td>1</td></tr> <tr><td>R-2F-8</td><td>扉（開運用）</td><td>1</td></tr> <tr><td>R-1F-14</td><td>扉（開運用）</td><td>1</td></tr> <tr><td>R-B1F-8</td><td>扉（開運用）</td><td>1</td></tr> <tr><td>R-B1F-12</td><td>扉（開運用）</td><td>1</td></tr> <tr><td>R-B2F-10</td><td>扉（開運用）</td><td>1</td></tr> <tr><td>R-3F-2</td><td>吹抜</td><td>1</td></tr> <tr><td>R-3F-4</td><td>吹抜</td><td>1</td></tr> <tr><td>R-3F-5</td><td>吹抜</td><td>1</td></tr> <tr><td>R-M3F-3-1</td><td>吹抜</td><td>1</td></tr> <tr><td>R-2F-6-2</td><td>吹抜</td><td>1</td></tr> <tr><td>R-2F-7-1</td><td>吹抜</td><td>1</td></tr> <tr><td>R-2F-8-2</td><td>吹抜</td><td>1</td></tr> <tr><td>R-M2F-9</td><td>吹抜</td><td>1</td></tr> <tr><td rowspan="6">制御建屋</td><td>C-3F-3</td><td>床開口</td><td>1</td></tr> <tr><td>C-3F-4</td><td>床開口</td><td>1</td></tr> <tr><td>C-2F-3</td><td>床開口</td><td>3</td></tr> <tr><td>C-2F-3</td><td>吹抜</td><td>1</td></tr> <tr><td>C-1F-4</td><td>床開口</td><td>3</td></tr> <tr><td>C-M11F-1</td><td>吹抜</td><td>1</td></tr> <tr><td rowspan="2">タービン建屋</td><td>C-M2F-1</td><td>吹抜</td><td>1</td></tr> <tr><td>T-1F-1</td><td>扉（開運用）</td><td>2</td></tr> <tr><td>T-B1F-1</td><td>扉（開運用）</td><td>2</td></tr> </tbody> </table>	建屋	区画番号	流下開口	数量	原子炉建屋付属棟	R-2F-5	扉（開運用）	1	R-2F-7	扉（開運用）	1	R-2F-8	扉（開運用）	1	R-1F-14	扉（開運用）	1	R-B1F-8	扉（開運用）	1	R-B1F-12	扉（開運用）	1	R-B2F-10	扉（開運用）	1	R-3F-2	吹抜	1	R-3F-4	吹抜	1	R-3F-5	吹抜	1	R-M3F-3-1	吹抜	1	R-2F-6-2	吹抜	1	R-2F-7-1	吹抜	1	R-2F-8-2	吹抜	1	R-M2F-9	吹抜	1	制御建屋	C-3F-3	床開口	1	C-3F-4	床開口	1	C-2F-3	床開口	3	C-2F-3	吹抜	1	C-1F-4	床開口	3	C-M11F-1	吹抜	1	タービン建屋	C-M2F-1	吹抜	1	T-1F-1	扉（開運用）	2	T-B1F-1	扉（開運用）	2		<p>【女川】</p> <p><u>記載表現の相違</u></p> <p><u>設計方針の相違</u></p> <ul style="list-style-type: none"> ・建屋名称、区画番号の相違。 ・泊は開運用の扉から溢水が流出し、没水水位を抑制することに期待していない。（先行PWRにおいても同様であることを先行PWRのまとめ資料に記載がないことをもって確認している。）
建屋	区画番号	流下開口	数量																																																																															
原子炉建屋付属棟	R-2F-5	扉（開運用）	1																																																																															
	R-2F-7	扉（開運用）	1																																																																															
	R-2F-8	扉（開運用）	1																																																																															
	R-1F-14	扉（開運用）	1																																																																															
	R-B1F-8	扉（開運用）	1																																																																															
	R-B1F-12	扉（開運用）	1																																																																															
	R-B2F-10	扉（開運用）	1																																																																															
	R-3F-2	吹抜	1																																																																															
	R-3F-4	吹抜	1																																																																															
	R-3F-5	吹抜	1																																																																															
	R-M3F-3-1	吹抜	1																																																																															
	R-2F-6-2	吹抜	1																																																																															
	R-2F-7-1	吹抜	1																																																																															
	R-2F-8-2	吹抜	1																																																																															
R-M2F-9	吹抜	1																																																																																
制御建屋	C-3F-3	床開口	1																																																																															
	C-3F-4	床開口	1																																																																															
	C-2F-3	床開口	3																																																																															
	C-2F-3	吹抜	1																																																																															
	C-1F-4	床開口	3																																																																															
	C-M11F-1	吹抜	1																																																																															
タービン建屋	C-M2F-1	吹抜	1																																																																															
	T-1F-1	扉（開運用）	2																																																																															
T-B1F-1	扉（開運用）	2																																																																																
	<p>3. 流下開口（扉）からの流出量</p> <p>(1) 扉からの流出量</p> <p>常時開の扉開口を想定し、カーブを乗り越えて溢水が伝播する際の越流水深と越流量との関係式について、「第四版土木工学ハンドブック1、土木学会編、技報堂出版」より、図1のような長方堰の流量算出式を参照し、以下の式を利用した。</p>		<p>【女川】</p> <p><u>設計方針の相違</u></p> <p>泊は扉から溢水が流出し、没水水位を抑制することに期待していない。（先行PWRにおいても同様であることを先行PWRのまとめ資料に記載がないことをもって確認している。）</p>																																																																															

赤字：設備、運用又は体制の相違（設計方針の相違）
 青字：記載箇所又は記載内容の相違（記載方針の相違）
 緑字：記載表現、設備名称の相違（実質的な相違なし）

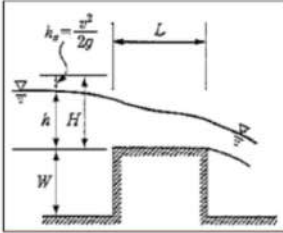
大阪発電所3/4号炉	女川原子力発電所2号炉	泊発電所3号炉	相違理由																								
	<div data-bbox="712 181 1263 715" style="border: 2px solid red; padding: 5px;"> <p>$Q=C \times B \times h^{\frac{3}{2}}$ …… ①式</p> <p>ここで、$0.4 \leq h/L \leq (1.5 \sim 1.9)$; $C=1.444+0.352(\frac{h}{L})$</p> <p>Q：越流量(m²/s) B：堰の幅(m) h：越流水深(m) C：流量係数(m²/s) L：堰長さ(m) W：堰高さ(m)</p>  </div> <p style="text-align: center;">図1 長方堰の越流量</p> <p>(2) 算出結果</p> <p>前述の式から越流量を算出した結果を表2に示す。没水高さ0.3mの場合、扉（1箇所）での越流水深は0.17mとなり、越流量は331m³/hとなる。原子炉建屋について、扉からの排出を期待する系統のうち、原子炉建屋原子炉棟における最大漏えい流量は263m³/h（高圧炉心スプレイ系）、原子炉建屋付属棟における最大漏えい流量は201m³/h（原子炉補機冷却水系）であり、扉からの流出量が上回っているため、没水高さ0.3m以上に達することはない。</p> <p style="text-align: center;">表2 扉の諸元と越流量算出結果（没水高さ0.3mの場合）</p> <table border="1" data-bbox="698 1142 1265 1279" style="border: 2px solid red; width: 100%;"> <thead> <tr> <th>項目</th> <th>記号</th> <th>値</th> <th>備考</th> </tr> </thead> <tbody> <tr> <td>堰高さ【カーブ高さ】(m)</td> <td>W</td> <td>0.13</td> <td></td> </tr> <tr> <td>堰長さ【カーブ奥行き】(m)</td> <td>L</td> <td>0.3</td> <td></td> </tr> <tr> <td>越流水深(m)</td> <td>h</td> <td>0.17</td> <td></td> </tr> <tr> <td>堰の幅【開口幅】(m)</td> <td>B</td> <td>0.8</td> <td>躯体開口は1m</td> </tr> <tr> <td>越流量(m³/h)</td> <td>Q</td> <td>331</td> <td></td> </tr> </tbody> </table>	項目	記号	値	備考	堰高さ【カーブ高さ】(m)	W	0.13		堰長さ【カーブ奥行き】(m)	L	0.3		越流水深(m)	h	0.17		堰の幅【開口幅】(m)	B	0.8	躯体開口は1m	越流量(m ³ /h)	Q	331			<p>【女川】</p> <p>設計方針の相違</p> <p>泊は扉から溢水が流出し、没水水位を抑制することに期待していない。（先行PWRにおいても同様であることを資料に記載がないことをもって確認している。）</p>
項目	記号	値	備考																								
堰高さ【カーブ高さ】(m)	W	0.13																									
堰長さ【カーブ奥行き】(m)	L	0.3																									
越流水深(m)	h	0.17																									
堰の幅【開口幅】(m)	B	0.8	躯体開口は1m																								
越流量(m ³ /h)	Q	331																									

赤字：設備、運用又は体制の相違（設計方針の相違）
 青字：記載箇所又は記載内容の相違（記載方針の相違）
 緑字：記載表現、設備名称の相違（実質的な相違なし）

大阪発電所3/4号炉	女川原子力発電所2号炉	泊発電所3号炉	相違理由																																
	<p>4. 流下開口（床開口）からの流出量</p> <p>建屋内の床面に開口を設置する対策について、開口部からの流出流量が想定破損時による系統流量を上回ることを確認する。</p> <p>(1) 評価条件</p> <ul style="list-style-type: none"> 床開口は満水流れとして評価を実施する。 下記に示す評価式のとおり、流量は落差が大きいくほど大きくなるため、スラブ上の滞留深さは考慮せず、落差としてはスラブ厚さを考慮する。 床開口は円形とし、φ100mmと設定する。 <div style="border: 2px solid red; padding: 5px; margin: 10px 0;"> $Q = A \sqrt{\frac{2gH}{\lambda \frac{L}{d} + \xi + 1}} \dots\dots \text{②式}$ <p>Q：流量(m³/s) A：断面積(m²) H：落差(m) d：内径(m) L：直管長(m) ξ：損失係数 λ：摩擦係数 g：重力加速度(m/s²)</p> </div> <p>(2) 算出結果</p> <p>表3の結果より、床開口1箇所あたりの流出流量は52.8m³/hとなった。この条件をもとに、想定破損時の系統流量が排出可能な必要開口数を表4に示す。必要開口数を設置することにより、床面からの開口から系統流量が排出可能であることを確認した。</p> <p style="text-align: center;">表3 床開口1箇所あたりの流出流量算出結果</p> <table border="1" style="width: 100%; border-collapse: collapse;"> <thead> <tr> <th>項目</th> <th>記号</th> <th>値</th> <th>備考</th> </tr> </thead> <tbody> <tr> <td>内径(m)</td> <td>d</td> <td>0.10</td> <td></td> </tr> <tr> <td>摩擦係数</td> <td>λ</td> <td>0.06</td> <td>最も粗度の高いコンクリート管(管壁の粗度0.03)を想定</td> </tr> <tr> <td>直管長(m)</td> <td>L</td> <td>0.3</td> <td>スラブ厚さ</td> </tr> <tr> <td>損失係数</td> <td>ξ</td> <td>0.5</td> <td>管路入口における損失は、最も損失が大きい角端を想定</td> </tr> <tr> <td>重力加速度(m/s²)</td> <td>g</td> <td>9.80665</td> <td></td> </tr> <tr> <td>落差(m)</td> <td>H</td> <td>0.3</td> <td>スラブ上の滞留深さは考慮せずスラブ厚さのみを考慮</td> </tr> <tr> <td>流量(m³/h)</td> <td>Q</td> <td>52.8</td> <td>開口部1箇所からの流出流量</td> </tr> </tbody> </table>	項目	記号	値	備考	内径(m)	d	0.10		摩擦係数	λ	0.06	最も粗度の高いコンクリート管(管壁の粗度0.03)を想定	直管長(m)	L	0.3	スラブ厚さ	損失係数	ξ	0.5	管路入口における損失は、最も損失が大きい角端を想定	重力加速度(m/s ²)	g	9.80665		落差(m)	H	0.3	スラブ上の滞留深さは考慮せずスラブ厚さのみを考慮	流量(m ³ /h)	Q	52.8	開口部1箇所からの流出流量		<p>【女川】</p> <p><u>設計方針の相違</u></p> <p>泊は円形の床開口から溢水が流出し、没水水位を抑制することに期待していない。(先行PWRにおいても同様であることを資料に記載がないことをもって確認している。)</p>
項目	記号	値	備考																																
内径(m)	d	0.10																																	
摩擦係数	λ	0.06	最も粗度の高いコンクリート管(管壁の粗度0.03)を想定																																
直管長(m)	L	0.3	スラブ厚さ																																
損失係数	ξ	0.5	管路入口における損失は、最も損失が大きい角端を想定																																
重力加速度(m/s ²)	g	9.80665																																	
落差(m)	H	0.3	スラブ上の滞留深さは考慮せずスラブ厚さのみを考慮																																
流量(m ³ /h)	Q	52.8	開口部1箇所からの流出流量																																

赤字：設備、運用又は体制の相違（設計方針の相違）
 青字：記載箇所又は記載内容の相違（記載方針の相違）
 緑字：記載表現、設備名称の相違（実質的な相違なし）

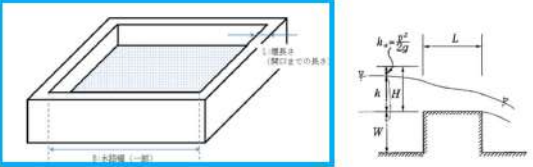
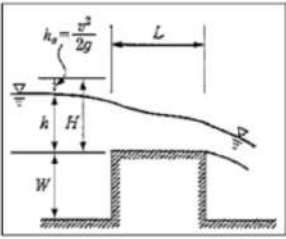
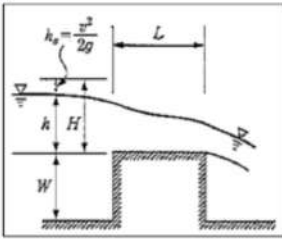
大阪発電所3/4号炉	女川原子力発電所2号炉	泊発電所3号炉	相違理由																	
<p>大阪発電所3/4号炉</p>	<p>女川原子力発電所2号炉</p> <p>表4 想定破損時の系統流量が排出可能な必要開口数</p> <table border="1" data-bbox="698 220 1270 368"> <thead> <tr> <th>区画番号</th> <th>区画内系統漏えい流量(m³/h)*</th> <th>床開口数</th> <th>床開口からの流出流量(m³/h)</th> </tr> </thead> <tbody> <tr> <td>C-3F-3</td> <td>20.1(消火系)</td> <td>1</td> <td>52.8</td> </tr> <tr> <td>C-3F-4</td> <td>9.1(貯内用水)</td> <td>1</td> <td>52.8</td> </tr> <tr> <td>C-2F-3</td> <td rowspan="2">155 (B/C)</td> <td rowspan="2">3</td> <td rowspan="2">158.4</td> </tr> <tr> <td>C-1F-4</td> </tr> </tbody> </table> <p>* 区画内系統漏えい流量(m³/h)の値は、保守的に当該区画内を通過する配管口径ではなく、当該系統における最大口径を用いて評価した値</p>	区画番号	区画内系統漏えい流量(m³/h)*	床開口数	床開口からの流出流量(m³/h)	C-3F-3	20.1(消火系)	1	52.8	C-3F-4	9.1(貯内用水)	1	52.8	C-2F-3	155 (B/C)	3	158.4	C-1F-4	<p>泊発電所3号炉</p>	<p>相違理由</p> <p>【女川】 <u>設計方針の相違</u> 泊は円形の床開口から溢水が流出し、没水水位を抑制することに期待していない。(先行PWRにおいても同様であることを資料に記載がないことをもって確認している。)</p>
区画番号	区画内系統漏えい流量(m³/h)*	床開口数	床開口からの流出流量(m³/h)																	
C-3F-3	20.1(消火系)	1	52.8																	
C-3F-4	9.1(貯内用水)	1	52.8																	
C-2F-3	155 (B/C)	3	158.4																	
C-1F-4																				
<p>【島根2】 まとめ資料p.9条-別添1-補足4-1より抜粋 1. 機器搬入ハッチ等の開口部からの排出流量 1.1 機器搬入ハッチ等の開口部からの排出流量 一般的な機器搬入ハッチの形状を想定し、以下の式を利用して機器搬入ハッチ等の開口部からの排出流量を算出する。開口部概略図を図1-1に示す。(参考文献「土木学会 水理公式集 平成11年度版」)</p> $Q_{out} = C_{out} \times B \times h^{\frac{3}{2}} \dots\dots\dots (1)$ $C_{out} = 1.642 \times \left(\frac{h}{L}\right)^{0.022} \dots\dots\dots (2)$ <p> Q_{out} : 排出流量 [m³/s] B : 開口の幅 [m] C_{out} : 排出係数 [m^{1/2}/s] h : 溢水水位 [m] L : 開口までの長さ [m] W : 堰高さ [m] </p>  <p>図1-1 開口部概略図</p>	<p>5. 流下開口（ハッチ、吹抜）からの流出量</p> <p>「3. 流下開口（扉）からの流出量」より再掲</p> <p>3. 流下開口（扉）からの流出量</p> <p>(1) 扉からの流出量</p> <p>常時開の扉開口を想定し、カーブを乗り越えて溢水が伝播する際の越流水深と越流量との関係式について、「第四版土木工学ハンドブックⅠ，土木学会編，技報堂出版」より、図1のような長方堰の流量算出式を参照し、以下の式を利用した。</p> $Q = C \times B \times h^{\frac{3}{2}} \dots\dots\dots \textcircled{1}式$ <p>ここで、$0.4 \leq h/L \leq (1.5 \sim 1.9)$; $C = 1.444 + 0.352 \left(\frac{h}{L}\right)$</p> <p> Q : 越流量 [m³/s] B : 堰の幅 (m) h : 越流水深 (m) C : 流量係数 [m^{1/2}/s] L : 堰長さ (m) W : 堰高さ (m) </p>  <p>図1 長方堰の越流量</p>	<p>3. 流下開口（グレーチング、吹抜）からの流出量</p> <p>(1) グレーチング、吹抜からの流出量</p> <p>グレーチング、吹抜の開口を想定し、堰を乗り越えて溢水が伝播する際の越流水深と越流量との関係式について、「土木学会 水理公式集（平成11年版）」より、図1のような長方堰の流量算出式を参照し、以下の式を利用した。</p> $Q = C \times B \times h^{\frac{3}{2}} \dots\dots\dots \textcircled{1}式$ <p>ここで、$0 < h/L \leq 0.1$; $C = 1.642 \left(\frac{h}{L}\right)^{0.022}$</p> <p> Q : 越流量 [m³/s] B : 開口の幅 [m] h : 越流水深 [m] C : 流量係数 [m^{1/2}/s] L : 堰長さ [m] W : 堰高さ [m] </p>  <p>図1 長方堰の越流量</p>	<p>【女川】 <u>記載表現の相違</u> <u>記載方針の相違</u> ・泊は扉開口からの流出に期待しないため、本項において記載した。 ・女川は「3. 流下開口（扉）からの流出量」で左記の評価式を記載しており、ハッチ、吹抜からの流出流量についても左記の評価式を利用することを後述している。 また、女川でもハッチ、吹抜について、堰を考慮して評価を実施しているため、女川の「3. 流下開口（扉）からの流出量」の記載をグレーチング、ハッチに置き換えて記載する。 ・文献は異なるが利用している式に相違はない。(泊は島根と同様の文献を参照している。)</p> <p><u>設計方針の相違</u> 堰長さの保守性により、島根と同様の流出係数算出式に限定される。(島根と同様)</p> <p>【島根】 <u>記載方針の相違</u> 流出量の算出における、構文については、女川を参照し記載する。 <u>記載表現の相違</u></p>																	

赤字：設備、運用又は体制の相違（設計方針の相違）
 青字：記載箇所又は記載内容の相違（記載方針の相違）
 緑字：記載表現、設備名称の相違（実質的な相違なし）

大阪発電所3/4号炉	女川原子力発電所2号炉	泊発電所3号炉	相違理由
<p>【島根2号炉】 まとめ資料 p.9 条-別添1-補足4-2 より抜粋 なお、開口の幅については、周囲の壁等の状況や開口角部で流出が阻害される可能性も考慮し、排出を期待できる開口の幅の50%として設定する。</p>	<p>(1) 流下開口（ハッチ、吹抜）からの流出量評価の前提条件 ハッチ、吹抜からの流出量について、①式を使用して算出する。 一部、開口周囲にカーブがない箇所もあるが、ここでは保守的にカーブ高さ、カーブ幅を仮定した場合の流出量を算出する。 また、ハッチについては、開口4辺のうち、2辺から流出していくこととして算出する。 表5にハッチ、吹抜の開口条件を示す。</p>	<p>(2) 流下開口（グレーチング、吹抜）からの流出量評価の前提条件 グレーチング、吹抜からの流出量について、①式を使用して算出する。 一部、開口周囲に堰がない箇所もあるが、ここでは保守的に堰高さ、堰長さを仮定した場合の流出量を算出する。 なお、開口の幅については、周囲の壁等の状況や開口角部で流出が阻害される可能性も考慮し、排出を期待できる開口の幅の50%として設定する。 表2にグレーチング、吹抜の開口条件を示す。</p>	<p>【女川】 記載表現の相違 【女川】 設計方針の相違 開口の位置が部屋の端にあることや開口の幅が1辺のみであることを踏まえ、「開口の幅については、周囲の壁等の状況や開口角部で流出が阻害される可能性も考慮し、排出を期待できる開口の幅の50%として設定する。」（島根記載）を参考にし、泊も同様に、開口の幅については、流出を期待できる開口の幅の50%として設定する。</p>

赤字：設備、運用又は体制の相違（設計方針の相違）
 青字：記載箇所又は記載内容の相違（記載方針の相違）
 緑字：記載表現、設備名称の相違（実質的な相違なし）

大阪発電所3/4号炉	女川原子力発電所2号炉	泊発電所3号炉	相違理由																																																																																																																					
<p>【島根2号炉】</p> <p>まとめ資料p.9条-別添2-補足4-2より抜粋</p> <p>表1-1 開口部の各パラメータ値及び排出流量算出結果</p> <table border="1" data-bbox="136 320 654 453"> <tr><td>B: 開口の幅 [m]</td><td>12.5</td></tr> <tr><td>h: 溢水水位 [m]</td><td>0.32</td></tr> <tr><td>L: 開口までの長さ [m]</td><td>50</td></tr> <tr><td>h/L</td><td>0.0064</td></tr> <tr><td>C_m: 排出係数 [m²/s]</td><td>1.47</td></tr> <tr><td>Q_m: 排出流量 [m³/h]</td><td>11,988</td></tr> </table> <p>まとめ資料p.9条-別添1-補足4-1より抜粋</p> <p>なお、開口までの長さLを長くするほどに排出流量が少なくなることから、保守的に原子炉建物の二次格納施設の1辺に相当する50mとし、床面を長頂堰とみなして算出する。</p>	B: 開口の幅 [m]	12.5	h: 溢水水位 [m]	0.32	L: 開口までの長さ [m]	50	h/L	0.0064	C _m : 排出係数 [m ² /s]	1.47	Q _m : 排出流量 [m ³ /h]	11,988	<p>表5 ハッチ、吹抜の開口条件(1/2)</p> <table border="1" data-bbox="698 212 1272 630"> <thead> <tr> <th>区画番号</th> <th>開口数</th> <th>開口幅 (m)</th> <th>カーブ高さ (m)</th> <th>カーブ幅 (m)</th> </tr> </thead> <tbody> <tr><td>R-3F-1</td><td>1</td><td>6.5×5.5</td><td>0.13</td><td>0.25</td></tr> <tr><td>R-2F-3</td><td>1</td><td>6.5×5.5</td><td>0.13</td><td>0.25</td></tr> <tr><td>R-4F-2</td><td>1</td><td>3.0×3.0</td><td>0.13</td><td>0.25</td></tr> <tr><td>R-4F-3</td><td>1</td><td>3.1×3.1</td><td>0.13</td><td>0.25</td></tr> <tr><td>R-4F-1</td><td>1</td><td>11.1×2.2×2.2</td><td>0.13</td><td>0.2</td></tr> <tr><td>R-4F-2</td><td>1</td><td>—※1</td><td>—※1</td><td>—※1</td></tr> <tr><td>R-4F-3</td><td>1</td><td>3.3×1.05×3.3</td><td>0.13</td><td>0.25</td></tr> <tr><td>R-4F-5</td><td>1</td><td>3.9</td><td>0.13</td><td>0.2</td></tr> <tr><td>R-4F-6</td><td>1</td><td>—※1</td><td>—※1</td><td>—※1</td></tr> <tr><td>R-1F-8</td><td>1</td><td>6.5以上</td><td>0.13</td><td>0.25</td></tr> <tr><td>R-1F-9</td><td>1</td><td>2.7</td><td>0.13</td><td>0.25</td></tr> <tr><td>R-4F-1</td><td>1</td><td>3.1 (4.4) ※2</td><td>0.13</td><td>0.2</td></tr> <tr><td>R-4F-2</td><td>1</td><td>9.1以上</td><td>0.13</td><td>0.2</td></tr> <tr><td>R-4F-3</td><td>1</td><td>2.5 (4.4) ※2</td><td>0.13</td><td>0.2</td></tr> <tr><td>R-4F-4</td><td>1</td><td>5.6</td><td>0.13</td><td>0.2</td></tr> <tr><td>R-4F-7</td><td>1</td><td>—※1</td><td>—※1</td><td>—※1</td></tr> </tbody> </table> <p>※1 床なし区画 ※2 開口が2辺のため、小さいほうの値で評価</p>	区画番号	開口数	開口幅 (m)	カーブ高さ (m)	カーブ幅 (m)	R-3F-1	1	6.5×5.5	0.13	0.25	R-2F-3	1	6.5×5.5	0.13	0.25	R-4F-2	1	3.0×3.0	0.13	0.25	R-4F-3	1	3.1×3.1	0.13	0.25	R-4F-1	1	11.1×2.2×2.2	0.13	0.2	R-4F-2	1	—※1	—※1	—※1	R-4F-3	1	3.3×1.05×3.3	0.13	0.25	R-4F-5	1	3.9	0.13	0.2	R-4F-6	1	—※1	—※1	—※1	R-1F-8	1	6.5以上	0.13	0.25	R-1F-9	1	2.7	0.13	0.25	R-4F-1	1	3.1 (4.4) ※2	0.13	0.2	R-4F-2	1	9.1以上	0.13	0.2	R-4F-3	1	2.5 (4.4) ※2	0.13	0.2	R-4F-4	1	5.6	0.13	0.2	R-4F-7	1	—※1	—※1	—※1	<p>表2 グレーチング、吹抜の開口条件</p> <table border="1" data-bbox="1281 252 1863 391"> <thead> <tr> <th>区画番号</th> <th>開口数</th> <th>開口の幅 (m)</th> <th>堰高さ (m)</th> <th>堰長さ (m)</th> </tr> </thead> <tbody> <tr><td>3RB-D-N51</td><td>2※1</td><td>2.075</td><td>0.1</td><td>76.6※2</td></tr> <tr><td>3AB-H-2</td><td>1</td><td>1.35</td><td>0.1</td><td>56.2※2</td></tr> <tr><td>3AB-H-9</td><td>1</td><td>1.35</td><td>0.1</td><td>56.2※2</td></tr> </tbody> </table> <p>※1 周囲の壁等の状況や開口角部で流出が阻害される可能性を考慮して、評価上は開口部1箇所を想定 ※2 開口までの長さLを長くするほどに感流量が少なくなることから、保守的に建屋の長辺に相当する値とし、床面を長頂堰とみなして算出</p>	区画番号	開口数	開口の幅 (m)	堰高さ (m)	堰長さ (m)	3RB-D-N51	2※1	2.075	0.1	76.6※2	3AB-H-2	1	1.35	0.1	56.2※2	3AB-H-9	1	1.35	0.1	56.2※2	<p>【女川】</p> <p>記載表現の相違</p> <p>設計方針の相違</p> <ul style="list-style-type: none"> ・区画番号の相違。開口数、開口の幅、堰高さ、堰長さについては評価条件の相違。 ・泊の※1について、開口部は2箇所あるが、周囲の壁等の状況や開口角部で流出が阻害される可能性を考慮して、保守的に開口部1箇所を想定して評価を実施している。 ・泊の※2について、島根の記載を参考にし、開口までの長さを長くするほどに排出流量が少なくなることから、保守的に建屋の長辺を堰長さとして設定している。 ・女川の※1の床なし区画は、泊の開口条件にはない。 ・女川の※2の保守性については、泊では「排出を期待できる開口の幅の50%」としている。（島根と同様） <p>【島根】</p> <p>設計方針の相違</p> <ul style="list-style-type: none"> ・堰長さの保守性の設定について、島根では原子炉建物の二次格納施設の1辺に相当する50mを用いている。一方で、泊では原子炉建屋、原子炉補助建屋それぞれの長辺として設定しており、プラント設計違いによる評価条件の相違であり、考え方は同様である。
B: 開口の幅 [m]	12.5																																																																																																																							
h: 溢水水位 [m]	0.32																																																																																																																							
L: 開口までの長さ [m]	50																																																																																																																							
h/L	0.0064																																																																																																																							
C _m : 排出係数 [m ² /s]	1.47																																																																																																																							
Q _m : 排出流量 [m ³ /h]	11,988																																																																																																																							
区画番号	開口数	開口幅 (m)	カーブ高さ (m)	カーブ幅 (m)																																																																																																																				
R-3F-1	1	6.5×5.5	0.13	0.25																																																																																																																				
R-2F-3	1	6.5×5.5	0.13	0.25																																																																																																																				
R-4F-2	1	3.0×3.0	0.13	0.25																																																																																																																				
R-4F-3	1	3.1×3.1	0.13	0.25																																																																																																																				
R-4F-1	1	11.1×2.2×2.2	0.13	0.2																																																																																																																				
R-4F-2	1	—※1	—※1	—※1																																																																																																																				
R-4F-3	1	3.3×1.05×3.3	0.13	0.25																																																																																																																				
R-4F-5	1	3.9	0.13	0.2																																																																																																																				
R-4F-6	1	—※1	—※1	—※1																																																																																																																				
R-1F-8	1	6.5以上	0.13	0.25																																																																																																																				
R-1F-9	1	2.7	0.13	0.25																																																																																																																				
R-4F-1	1	3.1 (4.4) ※2	0.13	0.2																																																																																																																				
R-4F-2	1	9.1以上	0.13	0.2																																																																																																																				
R-4F-3	1	2.5 (4.4) ※2	0.13	0.2																																																																																																																				
R-4F-4	1	5.6	0.13	0.2																																																																																																																				
R-4F-7	1	—※1	—※1	—※1																																																																																																																				
区画番号	開口数	開口の幅 (m)	堰高さ (m)	堰長さ (m)																																																																																																																				
3RB-D-N51	2※1	2.075	0.1	76.6※2																																																																																																																				
3AB-H-2	1	1.35	0.1	56.2※2																																																																																																																				
3AB-H-9	1	1.35	0.1	56.2※2																																																																																																																				
	<p>表5 ハッチ、吹抜の開口条件(2/2)</p> <table border="1" data-bbox="698 799 1272 1109"> <thead> <tr> <th>区画番号</th> <th>開口数</th> <th>開口幅 (m)</th> <th>カーブ高さ (m)</th> <th>カーブ幅 (m)</th> </tr> </thead> <tbody> <tr><td>R-3F-2</td><td>1</td><td>2.7 (5.1) ※1</td><td>0.13</td><td>0.2</td></tr> <tr><td>R-3F-4</td><td>1</td><td>2.7 (3.0) ※1</td><td>0.13</td><td>0.2</td></tr> <tr><td>R-3F-5</td><td>1</td><td>6.1</td><td>0.13</td><td>0.2</td></tr> <tr><td>R-4F-3-1</td><td>1</td><td>3.85</td><td>0.13※2</td><td>0.30※2</td></tr> <tr><td>R-2F-6-2</td><td>1</td><td>4.1×1.6×4.1</td><td>0.13</td><td>0.15</td></tr> <tr><td>R-2F-7-1</td><td>1</td><td>4.7×1.5</td><td>0.13</td><td>0.15</td></tr> <tr><td>R-2F-8-2</td><td>1</td><td>4.1×1.6×4.1</td><td>0.13</td><td>0.15</td></tr> <tr><td>R-4F-9</td><td>1</td><td>4.0以上</td><td>0.13</td><td>0.25</td></tr> <tr><td>C-2F-3</td><td>1</td><td>3.9</td><td>0.13</td><td>0.25</td></tr> <tr><td>C-4F-1</td><td>1</td><td>4.4×1.2</td><td>0.13</td><td>0.25</td></tr> <tr><td>C-4F-1</td><td>1</td><td>6.5以上</td><td>0.13※2</td><td>0.30※2</td></tr> </tbody> </table> <p>※1 開口が2辺のため、小さいほうの値で評価 ※2 保守的に設定</p>	区画番号	開口数	開口幅 (m)	カーブ高さ (m)	カーブ幅 (m)	R-3F-2	1	2.7 (5.1) ※1	0.13	0.2	R-3F-4	1	2.7 (3.0) ※1	0.13	0.2	R-3F-5	1	6.1	0.13	0.2	R-4F-3-1	1	3.85	0.13※2	0.30※2	R-2F-6-2	1	4.1×1.6×4.1	0.13	0.15	R-2F-7-1	1	4.7×1.5	0.13	0.15	R-2F-8-2	1	4.1×1.6×4.1	0.13	0.15	R-4F-9	1	4.0以上	0.13	0.25	C-2F-3	1	3.9	0.13	0.25	C-4F-1	1	4.4×1.2	0.13	0.25	C-4F-1	1	6.5以上	0.13※2	0.30※2																																																											
区画番号	開口数	開口幅 (m)	カーブ高さ (m)	カーブ幅 (m)																																																																																																																				
R-3F-2	1	2.7 (5.1) ※1	0.13	0.2																																																																																																																				
R-3F-4	1	2.7 (3.0) ※1	0.13	0.2																																																																																																																				
R-3F-5	1	6.1	0.13	0.2																																																																																																																				
R-4F-3-1	1	3.85	0.13※2	0.30※2																																																																																																																				
R-2F-6-2	1	4.1×1.6×4.1	0.13	0.15																																																																																																																				
R-2F-7-1	1	4.7×1.5	0.13	0.15																																																																																																																				
R-2F-8-2	1	4.1×1.6×4.1	0.13	0.15																																																																																																																				
R-4F-9	1	4.0以上	0.13	0.25																																																																																																																				
C-2F-3	1	3.9	0.13	0.25																																																																																																																				
C-4F-1	1	4.4×1.2	0.13	0.25																																																																																																																				
C-4F-1	1	6.5以上	0.13※2	0.30※2																																																																																																																				

赤字：設備、運用又は体制の相違（設計方針の相違）
 青字：記載箇所又は記載内容の相違（記載方針の相違）
 緑字：記載表現、設備名称の相違（実質的な相違なし）

大阪発電所3/4号炉	女川原子力発電所2号炉	泊発電所3号炉	相違理由
<p>【島根2号炉】 まとめ資料p.9条-別添1-補足4-2より抜粋 結果としては、溢水水位が0.32m（この区画の最も低い浸水防護設備の高さ）にて排出流量は11,900m³/h程度となり、これは系統からの流出に対し、機器搬入ハッチ等の開口部からの排水を期待する系統の中の最大流量337m³/h（原子炉補機冷却系）よりも上回っているため、没水高さがこの区画の最も低い浸水防護設備の高さ以上となることはない。</p>	<p>（2）算出結果 流下開口（ハッチ、吹抜）からの流出量に関して、越流水深を0.17mと仮定（没水高さ0.3m）した場合の算出結果を表6に示す。 越流量は十分に大きく、没水高さは0.3mを超えないことを確認した。</p>	<p>（3）算出結果 流下開口（グレーチング、吹抜）からの流出量の算出結果を表3に示す。 結果としては、3RB-D-N51では溢水水位が0.5m（この区画の最も低い溢水防護対象設備の機能喪失高さ）にて越流量は2,764m³/hとなり、これは系統からの流出に対し、当該開口部からの排水を期待する系統の中の最大流量2,091m³/h（主給水系）よりも上回っている。 また、3AB-H-2及び3AB-H-9では溢水水位が0.8m（この区画の最も低い溢水防護対象設備の機能喪失高さ）にて越流量4,243m³/hとなり、これは系統からの流出に対し、当該開口部からの排水を期待する系統の中の最大流量120m³/h（化学体積制御系（充てん配管））よりも上回っている。 以上より、没水高さがこれらの区画の最も低い溢水防護対象設備の機能喪失高さ以上となることはない。</p>	<p>【女川】 記載表現の相違 記載方針の相違 泊では、島根の構文を参考にし、結果を文章で示した後に表を掲載する。</p> <p>【島根】 設計方針の相違 ・溢水水位、最大流量、系統、越流量は評価条件の相違。 ・島根では浸水防護設備の高さに対して越流量を算出しているのに対して、泊では溢水防護対象設備の機能喪失高さに対して越流量を算出している。 記載方針の相違 ・2つの評価結果を示すため、区画を個別に記載する。 ・島根の1つの評価結果の構文を2つの評価結果を示すために、2回用いることによる構文の相違。 記載表現の相違</p>

赤字：設備、運用又は体制の相違（設計方針の相違）
 青字：記載箇所又は記載内容の相違（記載方針の相違）
 緑字：記載表現、設備名称の相違（実質的な相違なし）

大阪発電所3/4号炉	女川原子力発電所2号炉	泊発電所3号炉	相違理由																																																			
<p>【島根2号炉】 まとめ資料p.9条-別添1-補足4-2より抜粋 なお、開口の幅については、周囲の壁等の状況や開口角部で流出が阻害される可能性も考慮し、排出を期待できる開口の幅の50%として設定する。</p>	<p>表6 ハッチ、吹抜からの越流量算出結果(1/2)</p> <table border="1" data-bbox="703 209 1265 584"> <thead> <tr> <th>区画番号</th> <th>種別</th> <th>越流量 (m³/h)</th> </tr> </thead> <tbody> <tr><td>R-3F-1</td><td>ハッチ</td><td>4672^{※1}</td></tr> <tr><td>R-2F-3</td><td>ハッチ</td><td>4672^{※1}</td></tr> <tr><td>R-B2F-2</td><td>ハッチ</td><td>2548^{※1}</td></tr> <tr><td>R-B2F-3</td><td>ハッチ</td><td>2633^{※1}</td></tr> <tr><td>R-M2F-1</td><td>吹抜</td><td>4882</td></tr> <tr><td>R-M2F-3</td><td>吹抜</td><td>1401</td></tr> <tr><td>R-M2F-5</td><td>吹抜</td><td>1715</td></tr> <tr><td>R-1F-8</td><td>吹抜</td><td>2761</td></tr> <tr><td>R-1F-9</td><td>吹抜</td><td>1146</td></tr> <tr><td>R-MB1F-1</td><td>吹抜</td><td>1363</td></tr> <tr><td>R-MB1F-2</td><td>吹抜</td><td>4002</td></tr> <tr><td>R-MB1F-3</td><td>吹抜</td><td>1099</td></tr> </tbody> </table> <p>※1 開口4辺のうち、小さい2辺からの流出を想定</p>	区画番号	種別	越流量 (m ³ /h)	R-3F-1	ハッチ	4672 ^{※1}	R-2F-3	ハッチ	4672 ^{※1}	R-B2F-2	ハッチ	2548 ^{※1}	R-B2F-3	ハッチ	2633 ^{※1}	R-M2F-1	吹抜	4882	R-M2F-3	吹抜	1401	R-M2F-5	吹抜	1715	R-1F-8	吹抜	2761	R-1F-9	吹抜	1146	R-MB1F-1	吹抜	1363	R-MB1F-2	吹抜	4002	R-MB1F-3	吹抜	1099	<p>表3 グレーチング、吹抜からの越流量算出結果</p> <table border="1" data-bbox="1285 209 1854 357"> <thead> <tr> <th>区画番号</th> <th>種別</th> <th>越流量 (m³/h)</th> </tr> </thead> <tbody> <tr><td>3RB-D-N51</td><td>グレーチング</td><td>2,764</td></tr> <tr><td>3AB-H-2</td><td>吹抜</td><td>4,243</td></tr> <tr><td>3AB-H-9</td><td>吹抜</td><td>4,243</td></tr> </tbody> </table>	区画番号	種別	越流量 (m ³ /h)	3RB-D-N51	グレーチング	2,764	3AB-H-2	吹抜	4,243	3AB-H-9	吹抜	4,243	<p>【女川】 <u>設計方針の相違</u> ・区画番号、種別、越流量の数値については、評価条件の相違。 ・女川は「開口4辺のうち、小さい2辺からの流出を想定」として いるところに対して、泊は、開口の幅については、流出を期待できる開口の幅の50%として設定する。 （島根と同様）</p>
区画番号	種別	越流量 (m ³ /h)																																																				
R-3F-1	ハッチ	4672 ^{※1}																																																				
R-2F-3	ハッチ	4672 ^{※1}																																																				
R-B2F-2	ハッチ	2548 ^{※1}																																																				
R-B2F-3	ハッチ	2633 ^{※1}																																																				
R-M2F-1	吹抜	4882																																																				
R-M2F-3	吹抜	1401																																																				
R-M2F-5	吹抜	1715																																																				
R-1F-8	吹抜	2761																																																				
R-1F-9	吹抜	1146																																																				
R-MB1F-1	吹抜	1363																																																				
R-MB1F-2	吹抜	4002																																																				
R-MB1F-3	吹抜	1099																																																				
区画番号	種別	越流量 (m ³ /h)																																																				
3RB-D-N51	グレーチング	2,764																																																				
3AB-H-2	吹抜	4,243																																																				
3AB-H-9	吹抜	4,243																																																				
<p>【島根2号炉】 まとめ資料p.9条-別添1-補足4-2より抜粋 なお、開口の幅については、周囲の壁等の状況や開口角部で流出が阻害される可能性も考慮し、排出を期待できる開口の幅の50%として設定する。</p>	<p>表6 ハッチ、吹抜からの越流量算出結果(2/2)</p> <table border="1" data-bbox="703 687 1265 1062"> <thead> <tr> <th>区画番号</th> <th>種別</th> <th>越流量 (m³/h)</th> </tr> </thead> <tbody> <tr><td>R-MB1F-4</td><td>吹抜</td><td>2463</td></tr> <tr><td>R-3F-2</td><td>吹抜</td><td>1187</td></tr> <tr><td>R-3F-4</td><td>吹抜</td><td>1187</td></tr> <tr><td>R-3F-5</td><td>吹抜</td><td>2683</td></tr> <tr><td>R-M3F-3-1</td><td>吹抜</td><td>1596</td></tr> <tr><td>R-2F-6-2</td><td>吹抜</td><td>1906</td></tr> <tr><td>R-2F-7-1</td><td>吹抜</td><td>1395^{※1}</td></tr> <tr><td>R-2F-8-2</td><td>吹抜</td><td>1906</td></tr> <tr><td>R-M2F-9</td><td>吹抜</td><td>1699</td></tr> <tr><td>C-2F-3</td><td>吹抜</td><td>1656</td></tr> <tr><td>C-MB1F-1</td><td>吹抜</td><td>1019^{※1}</td></tr> <tr><td>C-MB2F-1</td><td>吹抜</td><td>2695</td></tr> </tbody> </table> <p>※1 開口4辺のうち、小さい2辺からの流出を想定</p>	区画番号	種別	越流量 (m ³ /h)	R-MB1F-4	吹抜	2463	R-3F-2	吹抜	1187	R-3F-4	吹抜	1187	R-3F-5	吹抜	2683	R-M3F-3-1	吹抜	1596	R-2F-6-2	吹抜	1906	R-2F-7-1	吹抜	1395 ^{※1}	R-2F-8-2	吹抜	1906	R-M2F-9	吹抜	1699	C-2F-3	吹抜	1656	C-MB1F-1	吹抜	1019 ^{※1}	C-MB2F-1	吹抜	2695														
区画番号	種別	越流量 (m ³ /h)																																																				
R-MB1F-4	吹抜	2463																																																				
R-3F-2	吹抜	1187																																																				
R-3F-4	吹抜	1187																																																				
R-3F-5	吹抜	2683																																																				
R-M3F-3-1	吹抜	1596																																																				
R-2F-6-2	吹抜	1906																																																				
R-2F-7-1	吹抜	1395 ^{※1}																																																				
R-2F-8-2	吹抜	1906																																																				
R-M2F-9	吹抜	1699																																																				
C-2F-3	吹抜	1656																																																				
C-MB1F-1	吹抜	1019 ^{※1}																																																				
C-MB2F-1	吹抜	2695																																																				

赤字：設備、運用又は体制の相違（設計方針の相違）
 青字：記載箇所又は記載内容の相違（記載方針の相違）
 緑字：記載表現、設備名称の相違（実質的な相違なし）

大阪発電所3/4号炉	女川原子力発電所2号炉	泊発電所3号炉	相違理由
<p>【大阪3/4号炉】 まとめ資料p.2-9-14より抜粋 ・具体的には、溢水防護区画内で発生する溢水に対しては、床ドレン、床面開口部及び床貫通部、壁貫通部、扉から他区画への流出は想定しない条件で溢水経路を設定し、溢水防護区画内の溢水水位を算出する。</p>	<p>6. 床ドレンからの排水について 女川2号炉内部溢水影響評価において、床ドレンからの流出を考慮する場合については以下のとおりとする。 (1) 評価条件 ・同一区画に目皿が複数ある場合は、床ドレン一箇所の閉塞を考慮した上で、他の床ドレン配管からの単位時間あたりの流出を考慮する。 ・床ドレンからの流出流量は、開口の有効面積と当該区画の水位を用いて以下の式より算出する。</p> <div style="border: 1px solid red; padding: 5px; width: fit-content; margin: 10px auto;"> <p>$Q = AC\sqrt{2gH}$ …… ③式</p> <p>Q：流量(m³/s) A：開口の有効面積(m²) H：当該区画の水位(m) C：流出流量損失係数 (=0.82) g：重力加速度 (m/s²)</p> </div> <p>7. 今後の運用管理について 女川原子力発電所原子炉施設保安規定に基づく規定文書として制定する「内部溢水対応要領書（仮称）」に、以下の内容を明記することとする。 なお、本事項は後段規則での対応が必要となる事項である。（別添2参照）</p> <p>(1) 内部溢水影響評価において、流下を考慮している開口部は、それがわかるように現場に表示を行うこと。</p> <p>(2) 内部溢水影響評価において、流下を考慮している開口部へ落下防止対策（ネットの設置、フェンスの設置等）を実施する場合は、カーブからの越流に影響を及ぼさないように配慮すること。</p>	<p>4. 今後の運用管理について 泊発電所原子炉施設保安規定に基づく規定文書として制定する「内部溢水対応要領（仮称）」に、以下の内容を明記することとする。 なお、本事項は後段規則での対応が必要となる事項である。（別添2参照）</p> <p>(1) 内部溢水影響評価において、流下を考慮している開口部は、それがわかるように現場に表示を行うこと。</p> <p>(2) 内部溢水影響評価において、流下を考慮している開口部へ落下防止対策（ネットの設置、フェンスの設置等）を実施する場合は、堰からの越流に影響を及ぼさないように配慮すること。</p>	<p>【女川】 設計方針の相違 泊は床ドレンからの排水に期待せずに溢水水位を算出し、没水影響評価を実施している。（大阪と同様）</p> <p>【女川】 記載表現の相違</p>

赤字：設備、運用又は体制の相違（設計方針の相違）
 青字：記載箇所又は記載内容の相違（記載方針の相違）
 緑字：記載表現、設備名称の相違（実質的な相違なし）

第9条 溢水による損傷の防止等（別添1 添付資料12）

大阪発電所3/4号炉	女川原子力発電所2号炉	泊発電所3号炉	相違理由
<p style="text-align: right;">補足資料 3-2</p> <p>溢水ガイド付録Aにしたがい、高エネルギー配管及び低エネルギー配管を以下のフローによって分類した。</p> <p style="text-align: center;">図1 高エネルギー配管と低エネルギー配管の分類フロー</p>	<p style="text-align: right;">添付資料 13</p> <p>溢水源となる対象系統について</p> <p>1. 溢水源となる対象系統の抽出及び分類</p> <p>溢水ガイドの定義に基づき、破損を想定する系統について、図1のフローに従い分類した。分類の結果について表1に示す。</p> <p style="text-align: center;">図1 高エネルギー配管と低エネルギー配管の分類フロー</p> <p><small>※1 防護対象設備が設置されている建屋と接続している建屋内の水系配管（油系配管含む）については、防護対象設備が設置されている建屋への溢水伝播の有無を確認するための対象とする。</small></p>	<p style="text-align: right;">添付資料 12</p> <p>溢水源となる対象系統について</p> <p>1. 溢水源となる対象系統の抽出及び分類</p> <p>溢水ガイドの定義に基づき、破損を想定する系統について、図1のフローに従い分類した。分類の結果について表1に示す。</p> <p style="text-align: center;">図1 高エネルギー配管と低エネルギー配管の分類フロー</p> <p><small>※1 防護対象設備が設置されている建屋と接続している建屋内の水系配管（油系配管含む）については、防護対象設備が設置されている建屋への溢水伝播の有無を確認するための対象とする。</small></p>	<p>【女川・大阪】 記載表現の相違</p> <p>【大阪】 記載表現の相違</p> <ul style="list-style-type: none"> ・記載の表現に相違があるものの、溢水ガイドに基づきフローを作成しているという点において、相違はない。 ・大阪の表現は異なるものの、対象としている配管は泊、女川と同様である。

赤字：設備、運用又は体制の相違（設計方針の相違）
 青字：記載箇所又は記載内容の相違（記載方針の相違）
 緑字：記載表現、設備名称の相違（実質的な相違なし）

第9条 溢水による損傷の防止等（別添1添付資料12）

大阪発電所3/4号炉

添付資料1.4.1-1

表1 配管破損を想定する高エネルギー配管の抽出結果

系統名	溢水評価における対象範囲	対象範囲における使用条件	配置
化学体積制御系	封水注入配管	運転圧力：約 17MPaG 運転温度：約 50℃	E/B
	充てん配管	運転圧力：約 17MPaG 運転温度：約 50℃	E/B
	抽出配管／非再生冷却器出口	運転圧力：約 2.2MPaG 運転温度：約 50℃	E/B
	抽出配管／非再生冷却器入口	運転圧力：約 2.2MPaG 運転温度：約 140℃	E/B
主蒸気系統	主蒸気管	運転圧力：約 6.03MPaG 運転温度：約 277℃	MS室
	主蒸気逃がし弁	運転圧力：約 6.03MPaG 運転温度：約 277℃	MS室
	主蒸気隔離弁 バイパス配管	運転圧力：約 6.03MPaG 運転温度：約 277℃	MS室
	主蒸気ドレン配管	運転圧力：約 6.03MPaG 運転温度：約 277℃	MS室
	タービン補助給水ポンプ 駆動用蒸気配管	運転圧力：約 6.03MPaG 運転温度：約 277℃	MS室
主給水系統	主給水管	運転圧力：約 6.03MPaG 運転温度：約 224℃	MS室
	主給水バイパス配管	運転圧力：約 6.03MPaG 運転温度：約 224℃	MS室
蒸気発生器 ブローダウン系	蒸気発生器ブローダウン 配管（貫通部へアングル弁）	運転圧力：約 6.03MPaG 運転温度：約 277℃	MS室、 BD室
補助給水系	補助給水配管	運転圧力：約 6.03MPaG 運転温度：約 224℃	MS室
補助蒸気系	補助蒸気供給配管	運転圧力：約 0.7MPaG 運転温度：約 170℃	E/B、 C/B

E/B：原子炉周辺建屋 C/B：制御建屋
 MS室：主蒸気・主給水管室 BD室：ブローダウンタンク室

女川原子力発電所2号炉

表1 低エネルギー配管・高エネルギー配管の分類と設置エリア
 (1/6)

系統	設計条件	分類		設置エリア	
		低エネ	高エネ	設置エリア	設置エリア
給水系	5.62	○	○	原子炉建屋 付属種	原子炉建屋 付属種
制御用動力水注系	13.83	○	○	原子炉建屋 付属種	原子炉建屋 付属種
ほう水注入系	1.73	○	○	原子炉建屋 付属種	原子炉建屋 付属種
西側循環冷却系	10.79	○*	○	原子炉建屋 付属種	原子炉建屋 付属種
原研中心スプレッド系	3.73	○*	○	原子炉建屋 付属種	原子炉建屋 付属種
原研中心スプレッド系	4.41	○*	○	原子炉建屋 付属種	原子炉建屋 付属種
原研中心スプレッド系	10.79	○*	○	原子炉建屋 付属種	原子炉建屋 付属種
原子炉隔離冷却系	8.62	○*	○	原子炉建屋 付属種	原子炉建屋 付属種
原子炉冷却時浄化系	10.20	○	○	原子炉建屋 付属種	原子炉建屋 付属種
燃料プール冷却	1.37	○	○	原子炉建屋 付属種	原子炉建屋 付属種
放射性ドレン除去系	0.98	○	○	原子炉建屋 付属種	原子炉建屋 付属種
機器ドレン系	0.98	○	○*	原子炉建屋 付属種	原子炉建屋 付属種
	1.94	○	○	原子炉建屋 付属種	原子炉建屋 付属種

※1 当該系統の運転時間が短いため、低エネルギー配管に分類する
 ※2 蒸気発生器処理エリアのみ
 ※3 復水側給水系の溢水量で考慮する
 ※4 休止設備であり保有水なし

泊発電所3号炉

表1 低エネルギー配管・高エネルギー配管の分類と設置エリア
 (1/3)

系統	設計条件	分類		設置エリア	
		低エネ	高エネ	設置エリア	設置エリア
1 冷却水系	運転圧力 15.4 運転温度 325 1.3 40	○	○	原子炉建屋 付属種	原子炉建屋 付属種
化学体積制御系（まてん配管）	17.0 202 0.11 46.1	○	○	原子炉建屋 付属種	原子炉建屋 付属種
化学体積制御系（抽出配管）	15.4 193 1.8 46.1	○	○	原子炉建屋 付属種	原子炉建屋 付属種
化学体積制御系（その他）	3.1 77	○	○	原子炉建屋 付属種	原子炉建屋 付属種
安全注入系 ^①	0.3 40	○	○	原子炉建屋 付属種	原子炉建屋 付属種
余熱除去系 ^②	0.35 40	○	○	原子炉建屋 付属種	原子炉建屋 付属種
主蒸気系	5.6 274	○	○	原子炉建屋 付属種	原子炉建屋 付属種
主給水系	3.8 220	○	○	原子炉建屋 付属種	原子炉建屋 付属種
原子炉格納貯留器	0.35 40	○	○	原子炉建屋 付属種	原子炉建屋 付属種
スプレッド系 ^③	1.1 43	○	○	原子炉建屋 付属種	原子炉建屋 付属種
使用済み燃料ビット水 浄化装置	1.1 65	○	○	原子炉建屋 付属種	原子炉建屋 付属種
原子炉隔離冷却系	0.61 26	○	○	原子炉建屋 付属種	原子炉建屋 付属種
気体発生器処理系	1.01 40	○	○	原子炉建屋 付属種	原子炉建屋 付属種

※1 当該系統の運転時間が短いため、低エネルギー配管に分類する

相違理由

【女川】
 記載表現の相違
 設計方針の相違
 ・表1において、泊は高エネルギー配管、低エネルギー配管の分類については、溢水ガイドに記載のとおり、「運転圧力」、「運転温度」を用いている。（大阪、高浜、美浜と同様）
 ・プラントの相違による、建屋名称、系統名の相違。

【大阪】
 記載方針の相違
 女川審査実績を反映し、表の構成を変更し、高エネルギー配管と低エネルギー配管を建屋ごとに星取表の形で抽出した。

赤字：設備、運用又は体制の相違（設計方針の相違）
 青字：記載箇所又は記載内容の相違（記載方針の相違）
 緑字：記載表現、設備名称の相違（実質的な相違なし）

第9条 溢水による損傷の防止等（別添1添付資料12）

大阪発電所3/4号炉	女川原子力発電所2号炉	泊発電所3号炉	相違理由																																																																																																																																																																																																																																															
<p>表2 配管破損を想定する低エネルギー配管の抽出結果</p>	<p>表1 低エネルギー配管・高エネルギー配管の分類と設置エリア (2/6)</p>	<p>表1 低エネルギー配管・高エネルギー配管の分類と設置エリア (2/3)</p>	<p>【女川】</p>																																																																																																																																																																																																																																															
<table border="1"> <thead> <tr> <th>系統名</th> </tr> </thead> <tbody> <tr><td>原子炉補機冷却系</td></tr> <tr><td>格納容器スプレイ系</td></tr> <tr><td>化学体積制御系</td></tr> <tr><td>冷水系</td></tr> <tr><td>1次系洗浄水系</td></tr> <tr><td>1次系放射性ドレン系(機器ドレン)</td></tr> <tr><td>1次系放射性ドレン系(床ドレン)</td></tr> <tr><td>消火水系</td></tr> <tr><td>1次系補給水系</td></tr> <tr><td>余熱除去系</td></tr> <tr><td>燃料取替用水系</td></tr> <tr><td>燃料ピット冷却浄化系</td></tr> <tr><td>安全注入系</td></tr> <tr><td>液体廃棄物処理系</td></tr> <tr><td>固体廃棄物処理系</td></tr> <tr><td>補助給水系(低温配管該当部分)</td></tr> </tbody> </table>	系統名	原子炉補機冷却系	格納容器スプレイ系	化学体積制御系	冷水系	1次系洗浄水系	1次系放射性ドレン系(機器ドレン)	1次系放射性ドレン系(床ドレン)	消火水系	1次系補給水系	余熱除去系	燃料取替用水系	燃料ピット冷却浄化系	安全注入系	液体廃棄物処理系	固体廃棄物処理系	補助給水系(低温配管該当部分)	<table border="1"> <thead> <tr> <th rowspan="2">系統</th> <th colspan="2">設計条件</th> <th colspan="2">分類</th> <th colspan="2">設置エリア</th> </tr> <tr> <th>最高使用圧力(MPa)</th> <th>最高使用温度(℃)</th> <th>低エネ</th> <th>高エネ</th> <th>原子炉種別</th> <th>原子炉種別</th> </tr> </thead> <tbody> <tr> <td>床ドレン・化学体積系</td> <td>0.85</td> <td>66</td> <td>○</td> <td>○</td> <td>原子炉種別</td> <td>原子炉種別</td> </tr> <tr> <td>ストームドレン系</td> <td>0.34</td> <td>146</td> <td></td> <td></td> <td>原子炉種別</td> <td>原子炉種別</td> </tr> <tr> <td>機スクラップ系</td> <td>0.86</td> <td>66</td> <td>○</td> <td>○</td> <td>原子炉種別</td> <td>原子炉種別</td> </tr> <tr> <td>濃縮機冷却系</td> <td>1.37</td> <td>66</td> <td>○</td> <td>○</td> <td>原子炉種別</td> <td>原子炉種別</td> </tr> <tr> <td>酸化系</td> <td>1.37</td> <td>95</td> <td>○</td> <td>○</td> <td>原子炉種別</td> <td>原子炉種別</td> </tr> <tr> <td>復水系</td> <td>0.35</td> <td>66</td> <td>○</td> <td>○</td> <td>原子炉種別</td> <td>原子炉種別</td> </tr> <tr> <td></td> <td>1.94</td> <td>66</td> <td>○</td> <td>○</td> <td>原子炉種別</td> <td>原子炉種別</td> </tr> <tr> <td></td> <td>0.08</td> <td>66</td> <td></td> <td></td> <td>原子炉種別</td> <td>原子炉種別</td> </tr> <tr> <td>給水系</td> <td>15.49</td> <td>180</td> <td>○</td> <td>○</td> <td>原子炉種別</td> <td>原子炉種別</td> </tr> <tr> <td>給水加熱器ドレン系</td> <td>0.62</td> <td>302</td> <td>○</td> <td>○</td> <td>原子炉種別</td> <td>原子炉種別</td> </tr> <tr> <td>復水ろ過機冷却系</td> <td>1.94</td> <td>66</td> <td>○</td> <td>○</td> <td>原子炉種別</td> <td>原子炉種別</td> </tr> <tr> <td></td> <td>0.68</td> <td>66</td> <td>○</td> <td>○</td> <td>原子炉種別</td> <td>原子炉種別</td> </tr> <tr> <td>復水貯留槽</td> <td>1.94</td> <td>66</td> <td>○</td> <td>○</td> <td>原子炉種別</td> <td>原子炉種別</td> </tr> <tr> <td></td> <td>0.09</td> <td>66</td> <td>○</td> <td>○</td> <td>原子炉種別</td> <td>原子炉種別</td> </tr> </tbody> </table>	系統	設計条件		分類		設置エリア		最高使用圧力(MPa)	最高使用温度(℃)	低エネ	高エネ	原子炉種別	原子炉種別	床ドレン・化学体積系	0.85	66	○	○	原子炉種別	原子炉種別	ストームドレン系	0.34	146			原子炉種別	原子炉種別	機スクラップ系	0.86	66	○	○	原子炉種別	原子炉種別	濃縮機冷却系	1.37	66	○	○	原子炉種別	原子炉種別	酸化系	1.37	95	○	○	原子炉種別	原子炉種別	復水系	0.35	66	○	○	原子炉種別	原子炉種別		1.94	66	○	○	原子炉種別	原子炉種別		0.08	66			原子炉種別	原子炉種別	給水系	15.49	180	○	○	原子炉種別	原子炉種別	給水加熱器ドレン系	0.62	302	○	○	原子炉種別	原子炉種別	復水ろ過機冷却系	1.94	66	○	○	原子炉種別	原子炉種別		0.68	66	○	○	原子炉種別	原子炉種別	復水貯留槽	1.94	66	○	○	原子炉種別	原子炉種別		0.09	66	○	○	原子炉種別	原子炉種別	<table border="1"> <thead> <tr> <th rowspan="2">系統</th> <th colspan="2">設計条件</th> <th colspan="2">分類</th> <th colspan="2">設置エリア</th> </tr> <tr> <th>運転圧力(MPa)</th> <th>運転温度(℃)</th> <th>低エネ</th> <th>高エネ</th> <th>原子炉種別</th> <th>原子炉種別</th> </tr> </thead> <tbody> <tr> <td>液体廃棄物処理系</td> <td>1.01</td> <td>80</td> <td>○</td> <td>○</td> <td>原子炉種別</td> <td>原子炉種別</td> </tr> <tr> <td>固体廃棄物処理系</td> <td>1.01</td> <td>40</td> <td>○</td> <td>○</td> <td>原子炉種別</td> <td>原子炉種別</td> </tr> <tr> <td>飲料採取系</td> <td>0.7</td> <td>46.1</td> <td>○</td> <td>○</td> <td>原子炉種別</td> <td>原子炉種別</td> </tr> <tr> <td>蒸気発生器ブローダウン系</td> <td>5.6</td> <td>274</td> <td>○</td> <td>○</td> <td>原子炉種別</td> <td>原子炉種別</td> </tr> <tr> <td>燃料取替用水系</td> <td>0.87</td> <td>40</td> <td>○</td> <td>○</td> <td>原子炉種別</td> <td>原子炉種別</td> </tr> <tr> <td>原子炉補給水系(脱塩水)</td> <td>1.05</td> <td>40</td> <td>○</td> <td>○</td> <td>原子炉種別</td> <td>原子炉種別</td> </tr> <tr> <td>原子炉補給水系(純水)</td> <td>1.01</td> <td>40</td> <td>○</td> <td>○</td> <td>原子炉種別</td> <td>原子炉種別</td> </tr> <tr> <td>補助蒸気系</td> <td>0.7</td> <td>170</td> <td>○</td> <td>○</td> <td>原子炉種別</td> <td>原子炉種別</td> </tr> <tr> <td></td> <td>0.1</td> <td>40</td> <td>○</td> <td>○</td> <td>原子炉種別</td> <td>原子炉種別</td> </tr> <tr> <td>水消火系</td> <td>1.8</td> <td>49</td> <td>○</td> <td>○</td> <td>原子炉種別</td> <td>原子炉種別</td> </tr> <tr> <td>地下水排水系</td> <td>0.47</td> <td>40</td> <td>○</td> <td>○</td> <td>原子炉種別</td> <td>原子炉種別</td> </tr> <tr> <td>飲料水系</td> <td>0.51</td> <td>40</td> <td>○</td> <td>○</td> <td>原子炉種別</td> <td>原子炉種別</td> </tr> <tr> <td>海水電解装置海水供給・注入系</td> <td>0.61</td> <td>26</td> <td>○</td> <td>○</td> <td>原子炉種別</td> <td>原子炉種別</td> </tr> <tr> <td>空調用給水系</td> <td>1.0</td> <td>10</td> <td>○</td> <td>○</td> <td>原子炉種別</td> <td>原子炉種別</td> </tr> </tbody> </table>	系統	設計条件		分類		設置エリア		運転圧力(MPa)	運転温度(℃)	低エネ	高エネ	原子炉種別	原子炉種別	液体廃棄物処理系	1.01	80	○	○	原子炉種別	原子炉種別	固体廃棄物処理系	1.01	40	○	○	原子炉種別	原子炉種別	飲料採取系	0.7	46.1	○	○	原子炉種別	原子炉種別	蒸気発生器ブローダウン系	5.6	274	○	○	原子炉種別	原子炉種別	燃料取替用水系	0.87	40	○	○	原子炉種別	原子炉種別	原子炉補給水系(脱塩水)	1.05	40	○	○	原子炉種別	原子炉種別	原子炉補給水系(純水)	1.01	40	○	○	原子炉種別	原子炉種別	補助蒸気系	0.7	170	○	○	原子炉種別	原子炉種別		0.1	40	○	○	原子炉種別	原子炉種別	水消火系	1.8	49	○	○	原子炉種別	原子炉種別	地下水排水系	0.47	40	○	○	原子炉種別	原子炉種別	飲料水系	0.51	40	○	○	原子炉種別	原子炉種別	海水電解装置海水供給・注入系	0.61	26	○	○	原子炉種別	原子炉種別	空調用給水系	1.0	10	○	○	原子炉種別	原子炉種別	<p>【女川】</p> <p>記載表現の相違 設計方針の相違</p> <p>・表1において、泊は高エネルギー配管、低エネルギー配管の分類については、溢水ガイドに記載のとおり、「運転圧力」、「運転温度」を用いている。(大阪、高浜、美浜と同様)</p> <p>・プラントの相違による、建屋名称、系統名の相違。</p> <p>【大阪】</p> <p>記載方針の相違</p> <p>女川審査実績を反映し、表の構成を変更し、高エネルギー配管と低エネルギー配管を建屋ごとに星取表の形で抽出した。</p>
系統名																																																																																																																																																																																																																																																		
原子炉補機冷却系																																																																																																																																																																																																																																																		
格納容器スプレイ系																																																																																																																																																																																																																																																		
化学体積制御系																																																																																																																																																																																																																																																		
冷水系																																																																																																																																																																																																																																																		
1次系洗浄水系																																																																																																																																																																																																																																																		
1次系放射性ドレン系(機器ドレン)																																																																																																																																																																																																																																																		
1次系放射性ドレン系(床ドレン)																																																																																																																																																																																																																																																		
消火水系																																																																																																																																																																																																																																																		
1次系補給水系																																																																																																																																																																																																																																																		
余熱除去系																																																																																																																																																																																																																																																		
燃料取替用水系																																																																																																																																																																																																																																																		
燃料ピット冷却浄化系																																																																																																																																																																																																																																																		
安全注入系																																																																																																																																																																																																																																																		
液体廃棄物処理系																																																																																																																																																																																																																																																		
固体廃棄物処理系																																																																																																																																																																																																																																																		
補助給水系(低温配管該当部分)																																																																																																																																																																																																																																																		
系統	設計条件		分類		設置エリア																																																																																																																																																																																																																																													
	最高使用圧力(MPa)	最高使用温度(℃)	低エネ	高エネ	原子炉種別	原子炉種別																																																																																																																																																																																																																																												
床ドレン・化学体積系	0.85	66	○	○	原子炉種別	原子炉種別																																																																																																																																																																																																																																												
ストームドレン系	0.34	146			原子炉種別	原子炉種別																																																																																																																																																																																																																																												
機スクラップ系	0.86	66	○	○	原子炉種別	原子炉種別																																																																																																																																																																																																																																												
濃縮機冷却系	1.37	66	○	○	原子炉種別	原子炉種別																																																																																																																																																																																																																																												
酸化系	1.37	95	○	○	原子炉種別	原子炉種別																																																																																																																																																																																																																																												
復水系	0.35	66	○	○	原子炉種別	原子炉種別																																																																																																																																																																																																																																												
	1.94	66	○	○	原子炉種別	原子炉種別																																																																																																																																																																																																																																												
	0.08	66			原子炉種別	原子炉種別																																																																																																																																																																																																																																												
給水系	15.49	180	○	○	原子炉種別	原子炉種別																																																																																																																																																																																																																																												
給水加熱器ドレン系	0.62	302	○	○	原子炉種別	原子炉種別																																																																																																																																																																																																																																												
復水ろ過機冷却系	1.94	66	○	○	原子炉種別	原子炉種別																																																																																																																																																																																																																																												
	0.68	66	○	○	原子炉種別	原子炉種別																																																																																																																																																																																																																																												
復水貯留槽	1.94	66	○	○	原子炉種別	原子炉種別																																																																																																																																																																																																																																												
	0.09	66	○	○	原子炉種別	原子炉種別																																																																																																																																																																																																																																												
系統	設計条件		分類		設置エリア																																																																																																																																																																																																																																													
	運転圧力(MPa)	運転温度(℃)	低エネ	高エネ	原子炉種別	原子炉種別																																																																																																																																																																																																																																												
液体廃棄物処理系	1.01	80	○	○	原子炉種別	原子炉種別																																																																																																																																																																																																																																												
固体廃棄物処理系	1.01	40	○	○	原子炉種別	原子炉種別																																																																																																																																																																																																																																												
飲料採取系	0.7	46.1	○	○	原子炉種別	原子炉種別																																																																																																																																																																																																																																												
蒸気発生器ブローダウン系	5.6	274	○	○	原子炉種別	原子炉種別																																																																																																																																																																																																																																												
燃料取替用水系	0.87	40	○	○	原子炉種別	原子炉種別																																																																																																																																																																																																																																												
原子炉補給水系(脱塩水)	1.05	40	○	○	原子炉種別	原子炉種別																																																																																																																																																																																																																																												
原子炉補給水系(純水)	1.01	40	○	○	原子炉種別	原子炉種別																																																																																																																																																																																																																																												
補助蒸気系	0.7	170	○	○	原子炉種別	原子炉種別																																																																																																																																																																																																																																												
	0.1	40	○	○	原子炉種別	原子炉種別																																																																																																																																																																																																																																												
水消火系	1.8	49	○	○	原子炉種別	原子炉種別																																																																																																																																																																																																																																												
地下水排水系	0.47	40	○	○	原子炉種別	原子炉種別																																																																																																																																																																																																																																												
飲料水系	0.51	40	○	○	原子炉種別	原子炉種別																																																																																																																																																																																																																																												
海水電解装置海水供給・注入系	0.61	26	○	○	原子炉種別	原子炉種別																																																																																																																																																																																																																																												
空調用給水系	1.0	10	○	○	原子炉種別	原子炉種別																																																																																																																																																																																																																																												
	<p>※1 当該系統の運転期間が短い。低エネルギー配管に分類する</p> <p>※2 廃棄物処理エリアのみ</p> <p>※3 復水補給水系の最高温度で考慮する</p> <p>※4 休止設備であり保有水なし</p>	<p>※1 当該系統の運転期間が短い。低エネルギー配管に分類する</p>																																																																																																																																																																																																																																																

赤字：設備、運用又は体制の相違（設計方針の相違）
 青字：記載箇所又は記載内容の相違（記載方針の相違）
 緑字：記載表現、設備名称の相違（実質的な相違なし）

大阪発電所3/4号炉	女川原子力発電所2号炉	泊発電所3号炉	相違理由																																																																																																																																																																																																																																																																																																																																																																		
	<p>表1 低エネルギー配管・高エネルギー配管の分類と設置エリア (3/6)</p> <table border="1"> <thead> <tr> <th rowspan="3">系統</th> <th colspan="2">設計条件</th> <th colspan="2">分類</th> <th colspan="4">設置エリア</th> </tr> <tr> <th rowspan="2">機系使用 圧力 (MPa)</th> <th rowspan="2">機系使用 温度(℃)</th> <th rowspan="2">高エネ</th> <th rowspan="2">低エネ</th> <th colspan="2">原子炉建屋</th> <th colspan="2">タービン 建屋</th> <th rowspan="2">補助 ボイラー 建屋</th> </tr> <tr> <th>付属機 管理</th> <th>付属機 管理</th> <th>タービン 管理</th> <th>タービン 管理</th> </tr> </thead> <tbody> <tr><td>原子炉冷却剤加水系</td><td>0.88</td><td>74</td><td>-</td><td>○</td><td>-</td><td>-</td><td>-</td><td>-</td><td>-</td></tr> <tr><td>循環水系</td><td>0.48</td><td>41</td><td>-</td><td>○</td><td>-</td><td>-</td><td>-</td><td>-</td><td>-</td></tr> <tr><td>低圧補給水系</td><td>1.18</td><td>66</td><td>-</td><td>○</td><td>-</td><td>-</td><td>○</td><td>-</td><td>-</td></tr> <tr><td>高圧補給水系</td><td>1.27</td><td>66</td><td>-</td><td>○</td><td>-</td><td>-</td><td>○</td><td>-</td><td>○</td></tr> <tr><td>小流量系</td><td>1.18</td><td>66</td><td>-</td><td>○</td><td>○</td><td>○</td><td>○</td><td>-</td><td>-</td></tr> <tr><td>燃料プール補給水系</td><td>1.27</td><td>66</td><td>-</td><td>○</td><td>-</td><td>-</td><td>-</td><td>-</td><td>-</td></tr> <tr><td>炉水用水系</td><td>1.07</td><td>40</td><td>-</td><td>○</td><td>○</td><td>○</td><td>○</td><td>○</td><td>-</td></tr> <tr><td>熱交換器冷却機 冷却剤加水系</td><td>1.27</td><td>66</td><td>-</td><td>○</td><td>○</td><td>○</td><td>○</td><td>-</td><td>-</td></tr> <tr><td>熱交換器冷却機 冷却剤加水系</td><td>0.88</td><td>66</td><td>-</td><td>○</td><td>○</td><td>○</td><td>○</td><td>-</td><td>-</td></tr> <tr><td>原子炉建屋冷却水系</td><td>1.18</td><td>88</td><td>-</td><td>○</td><td>○</td><td>○</td><td>○</td><td>-</td><td>-</td></tr> <tr><td>タービン建屋冷却機 冷却剤加水系</td><td>0.96</td><td>66</td><td>-</td><td>○</td><td>-</td><td>-</td><td>-</td><td>○</td><td>○</td></tr> <tr><td>原子炉建屋冷却機 冷却剤加水系</td><td>0.78</td><td>50</td><td>-</td><td>○</td><td>-</td><td>-</td><td>-</td><td>○</td><td>○</td></tr> <tr><td>タービン建屋冷却機 冷却剤加水系</td><td>0.69</td><td>41</td><td>-</td><td>○</td><td>-</td><td>-</td><td>-</td><td>○</td><td>○</td></tr> <tr><td>原子炉建屋冷却機 冷却剤加水系</td><td>1.18</td><td>70</td><td>-</td><td>○</td><td>○</td><td>○</td><td>○</td><td>-</td><td>-</td></tr> </tbody> </table> <p>※1 当該系統の運転期間が短いため、低エネルギー配管に分類する ※2 廃棄物処理エリアのみ ※3 炉水補給水系の流量数で誘導する ※4 休止設備であり保有水なし</p>	系統	設計条件		分類		設置エリア				機系使用 圧力 (MPa)	機系使用 温度(℃)	高エネ	低エネ	原子炉建屋		タービン 建屋		補助 ボイラー 建屋	付属機 管理	付属機 管理	タービン 管理	タービン 管理	原子炉冷却剤加水系	0.88	74	-	○	-	-	-	-	-	循環水系	0.48	41	-	○	-	-	-	-	-	低圧補給水系	1.18	66	-	○	-	-	○	-	-	高圧補給水系	1.27	66	-	○	-	-	○	-	○	小流量系	1.18	66	-	○	○	○	○	-	-	燃料プール補給水系	1.27	66	-	○	-	-	-	-	-	炉水用水系	1.07	40	-	○	○	○	○	○	-	熱交換器冷却機 冷却剤加水系	1.27	66	-	○	○	○	○	-	-	熱交換器冷却機 冷却剤加水系	0.88	66	-	○	○	○	○	-	-	原子炉建屋冷却水系	1.18	88	-	○	○	○	○	-	-	タービン建屋冷却機 冷却剤加水系	0.96	66	-	○	-	-	-	○	○	原子炉建屋冷却機 冷却剤加水系	0.78	50	-	○	-	-	-	○	○	タービン建屋冷却機 冷却剤加水系	0.69	41	-	○	-	-	-	○	○	原子炉建屋冷却機 冷却剤加水系	1.18	70	-	○	○	○	○	-	-	<p>表1 低エネルギー配管・高エネルギー配管の分類と設置エリア (3/3)</p> <table border="1"> <thead> <tr> <th rowspan="3">系統</th> <th colspan="2">設計条件</th> <th colspan="2">分類</th> <th colspan="4">設置エリア</th> </tr> <tr> <th rowspan="2">運転圧力 (MPa)</th> <th rowspan="2">運転温度 (℃)</th> <th rowspan="2">高エネ</th> <th rowspan="2">低エネ</th> <th colspan="2">原子炉建屋</th> <th colspan="2">タービン 建屋</th> <th rowspan="2">タービン 建屋</th> </tr> <tr> <th>管理</th> <th>非管理</th> <th>管理</th> <th>非管理</th> </tr> </thead> <tbody> <tr><td>保水系</td><td>5.25</td><td>208</td><td>○</td><td>○</td><td>-</td><td>-</td><td>-</td><td>-</td><td>-</td></tr> <tr><td>潤滑水系</td><td>1.2</td><td>40</td><td>-</td><td>○</td><td>-</td><td>-</td><td>-</td><td>-</td><td>-</td></tr> <tr><td>軸受冷却系</td><td>0.69</td><td>26</td><td>-</td><td>○</td><td>-</td><td>-</td><td>-</td><td>-</td><td>-</td></tr> <tr><td>凝縮注入装置</td><td>0.65</td><td>30</td><td>-</td><td>○</td><td>-</td><td>-</td><td>-</td><td>-</td><td>-</td></tr> <tr><td>補助給水系①</td><td>2.0</td><td>30</td><td>-</td><td>○</td><td>-</td><td>-</td><td>-</td><td>-</td><td>-</td></tr> <tr><td>補助給水系②</td><td>0.1</td><td>30</td><td>-</td><td>○</td><td>-</td><td>-</td><td>-</td><td>-</td><td>-</td></tr> <tr><td>凝縮注入装置</td><td>5.8</td><td>220</td><td>○</td><td>○</td><td>○</td><td>○</td><td>○</td><td>○</td><td>○</td></tr> <tr><td>タービン建屋冷却機 冷却剤加水系</td><td>0.3</td><td>40</td><td>-</td><td>○</td><td>-</td><td>-</td><td>-</td><td>-</td><td>-</td></tr> <tr><td>炉水スプレー特水系</td><td>0.7</td><td>26</td><td>-</td><td>○</td><td>-</td><td>-</td><td>-</td><td>-</td><td>-</td></tr> <tr><td>炉内用水系</td><td>1.09</td><td>29</td><td>-</td><td>○</td><td>-</td><td>-</td><td>-</td><td>-</td><td>-</td></tr> <tr><td>炉水浄化設備</td><td>0.91</td><td>25</td><td>-</td><td>○</td><td>-</td><td>-</td><td>-</td><td>-</td><td>-</td></tr> <tr><td>タービン建屋冷却機 冷却剤加水系</td><td>0.11</td><td>65</td><td>-</td><td>○</td><td>-</td><td>-</td><td>-</td><td>-</td><td>-</td></tr> <tr><td>スチームコンパクター系</td><td>2.46</td><td>220</td><td>-</td><td>○</td><td>-</td><td>-</td><td>-</td><td>-</td><td>-</td></tr> <tr><td>タービン建屋冷却機 冷却剤加水系</td><td>1.2</td><td>40</td><td>-</td><td>○</td><td>-</td><td>-</td><td>-</td><td>-</td><td>-</td></tr> <tr><td>タービン建屋冷却機 冷却剤加水系</td><td>5.48</td><td>271</td><td>○</td><td>○</td><td>-</td><td>-</td><td>-</td><td>-</td><td>-</td></tr> <tr><td>凝縮注入装置</td><td>0.65</td><td>30</td><td>○</td><td>○</td><td>○</td><td>○</td><td>○</td><td>○</td><td>○</td></tr> <tr><td>凝縮注入装置</td><td>0.65</td><td>30</td><td>○</td><td>○</td><td>○</td><td>○</td><td>○</td><td>○</td><td>○</td></tr> </tbody> </table> <p>※1 当該系統の運転期間が短いため、低エネルギー配管に分類する</p>	系統	設計条件		分類		設置エリア				運転圧力 (MPa)	運転温度 (℃)	高エネ	低エネ	原子炉建屋		タービン 建屋		タービン 建屋	管理	非管理	管理	非管理	保水系	5.25	208	○	○	-	-	-	-	-	潤滑水系	1.2	40	-	○	-	-	-	-	-	軸受冷却系	0.69	26	-	○	-	-	-	-	-	凝縮注入装置	0.65	30	-	○	-	-	-	-	-	補助給水系①	2.0	30	-	○	-	-	-	-	-	補助給水系②	0.1	30	-	○	-	-	-	-	-	凝縮注入装置	5.8	220	○	○	○	○	○	○	○	タービン建屋冷却機 冷却剤加水系	0.3	40	-	○	-	-	-	-	-	炉水スプレー特水系	0.7	26	-	○	-	-	-	-	-	炉内用水系	1.09	29	-	○	-	-	-	-	-	炉水浄化設備	0.91	25	-	○	-	-	-	-	-	タービン建屋冷却機 冷却剤加水系	0.11	65	-	○	-	-	-	-	-	スチームコンパクター系	2.46	220	-	○	-	-	-	-	-	タービン建屋冷却機 冷却剤加水系	1.2	40	-	○	-	-	-	-	-	タービン建屋冷却機 冷却剤加水系	5.48	271	○	○	-	-	-	-	-	凝縮注入装置	0.65	30	○	○	○	○	○	○	○	凝縮注入装置	0.65	30	○	○	○	○	○	○	○	<p>【女川】 記載表現の相違 設計方針の相違 ・表1において、泊は高エネルギー配管、低エネルギー配管の分類については、溢水ガイドに記載のとおり、「運転圧力」、「運転温度」を用いている。(大飯、高浜、美浜と同様) ・プラントの相違による、建屋名称、系統名の相違。</p>
系統	設計条件		分類		設置エリア																																																																																																																																																																																																																																																																																																																																																																
	機系使用 圧力 (MPa)		機系使用 温度(℃)	高エネ	低エネ	原子炉建屋		タービン 建屋		補助 ボイラー 建屋																																																																																																																																																																																																																																																																																																																																																											
		付属機 管理				付属機 管理	タービン 管理	タービン 管理																																																																																																																																																																																																																																																																																																																																																													
原子炉冷却剤加水系	0.88	74	-	○	-	-	-	-	-																																																																																																																																																																																																																																																																																																																																																												
循環水系	0.48	41	-	○	-	-	-	-	-																																																																																																																																																																																																																																																																																																																																																												
低圧補給水系	1.18	66	-	○	-	-	○	-	-																																																																																																																																																																																																																																																																																																																																																												
高圧補給水系	1.27	66	-	○	-	-	○	-	○																																																																																																																																																																																																																																																																																																																																																												
小流量系	1.18	66	-	○	○	○	○	-	-																																																																																																																																																																																																																																																																																																																																																												
燃料プール補給水系	1.27	66	-	○	-	-	-	-	-																																																																																																																																																																																																																																																																																																																																																												
炉水用水系	1.07	40	-	○	○	○	○	○	-																																																																																																																																																																																																																																																																																																																																																												
熱交換器冷却機 冷却剤加水系	1.27	66	-	○	○	○	○	-	-																																																																																																																																																																																																																																																																																																																																																												
熱交換器冷却機 冷却剤加水系	0.88	66	-	○	○	○	○	-	-																																																																																																																																																																																																																																																																																																																																																												
原子炉建屋冷却水系	1.18	88	-	○	○	○	○	-	-																																																																																																																																																																																																																																																																																																																																																												
タービン建屋冷却機 冷却剤加水系	0.96	66	-	○	-	-	-	○	○																																																																																																																																																																																																																																																																																																																																																												
原子炉建屋冷却機 冷却剤加水系	0.78	50	-	○	-	-	-	○	○																																																																																																																																																																																																																																																																																																																																																												
タービン建屋冷却機 冷却剤加水系	0.69	41	-	○	-	-	-	○	○																																																																																																																																																																																																																																																																																																																																																												
原子炉建屋冷却機 冷却剤加水系	1.18	70	-	○	○	○	○	-	-																																																																																																																																																																																																																																																																																																																																																												
系統	設計条件		分類		設置エリア																																																																																																																																																																																																																																																																																																																																																																
	運転圧力 (MPa)	運転温度 (℃)	高エネ	低エネ	原子炉建屋		タービン 建屋		タービン 建屋																																																																																																																																																																																																																																																																																																																																																												
					管理	非管理	管理	非管理																																																																																																																																																																																																																																																																																																																																																													
保水系	5.25	208	○	○	-	-	-	-	-																																																																																																																																																																																																																																																																																																																																																												
潤滑水系	1.2	40	-	○	-	-	-	-	-																																																																																																																																																																																																																																																																																																																																																												
軸受冷却系	0.69	26	-	○	-	-	-	-	-																																																																																																																																																																																																																																																																																																																																																												
凝縮注入装置	0.65	30	-	○	-	-	-	-	-																																																																																																																																																																																																																																																																																																																																																												
補助給水系①	2.0	30	-	○	-	-	-	-	-																																																																																																																																																																																																																																																																																																																																																												
補助給水系②	0.1	30	-	○	-	-	-	-	-																																																																																																																																																																																																																																																																																																																																																												
凝縮注入装置	5.8	220	○	○	○	○	○	○	○																																																																																																																																																																																																																																																																																																																																																												
タービン建屋冷却機 冷却剤加水系	0.3	40	-	○	-	-	-	-	-																																																																																																																																																																																																																																																																																																																																																												
炉水スプレー特水系	0.7	26	-	○	-	-	-	-	-																																																																																																																																																																																																																																																																																																																																																												
炉内用水系	1.09	29	-	○	-	-	-	-	-																																																																																																																																																																																																																																																																																																																																																												
炉水浄化設備	0.91	25	-	○	-	-	-	-	-																																																																																																																																																																																																																																																																																																																																																												
タービン建屋冷却機 冷却剤加水系	0.11	65	-	○	-	-	-	-	-																																																																																																																																																																																																																																																																																																																																																												
スチームコンパクター系	2.46	220	-	○	-	-	-	-	-																																																																																																																																																																																																																																																																																																																																																												
タービン建屋冷却機 冷却剤加水系	1.2	40	-	○	-	-	-	-	-																																																																																																																																																																																																																																																																																																																																																												
タービン建屋冷却機 冷却剤加水系	5.48	271	○	○	-	-	-	-	-																																																																																																																																																																																																																																																																																																																																																												
凝縮注入装置	0.65	30	○	○	○	○	○	○	○																																																																																																																																																																																																																																																																																																																																																												
凝縮注入装置	0.65	30	○	○	○	○	○	○	○																																																																																																																																																																																																																																																																																																																																																												

赤字：設備、運用又は体制の相違（設計方針の相違）
 青字：記載箇所又は記載内容の相違（記載方針の相違）
 緑字：記載表現、設備名称の相違（実質的な相違なし）

大阪発電所3/4号炉	女川原子力発電所2号炉	泊発電所3号炉	相違理由																																																																																																																																																																										
	<p>表1 低エネルギー配管・高エネルギー配管の分類と設置エリア (4/6)</p> <table border="1" data-bbox="696 239 1164 1149"> <thead> <tr> <th rowspan="3">系統</th> <th colspan="2">設計条件</th> <th colspan="2">分類</th> <th colspan="10">設置エリア</th> </tr> <tr> <th rowspan="2">静圧(MPa)</th> <th rowspan="2">最高使用温度(℃)</th> <th rowspan="2">高エネ</th> <th rowspan="2">低エネ</th> <th colspan="2">原子炉設置</th> <th colspan="2">炉内設置</th> <th colspan="2">タービン設置</th> <th rowspan="2">補助ボイラー設置</th> <th rowspan="2">機水ポンプ室</th> <th rowspan="2">CS1エリア</th> <th rowspan="2">LOTエリア</th> </tr> <tr> <th>原子炉種</th> <th>付属機</th> <th>付属機</th> <th>付属機</th> <th>タービン</th> <th>管理</th> </tr> </thead> <tbody> <tr> <td>新庄原子力発電所2号炉</td> <td>0.78</td> <td>50</td> <td>-</td> <td>○</td> <td>-</td> <td>○</td> <td>-</td> <td>-</td> <td>-</td> <td>-</td> <td>-</td> <td>○</td> <td>-</td> <td>-</td> </tr> <tr> <td>新庄原子力発電所2号炉</td> <td>2.55</td> <td>294</td> <td>○</td> <td>-</td> <td>-</td> <td>-</td> <td>-</td> <td>-</td> <td>-</td> <td>-</td> <td>-</td> <td>-</td> <td>-</td> <td>-</td> </tr> <tr> <td>新庄原子力発電所2号炉</td> <td>3.43</td> <td>300</td> <td>○</td> <td>-</td> <td>-</td> <td>-</td> <td>-</td> <td>-</td> <td>-</td> <td>-</td> <td>-</td> <td>-</td> <td>-</td> <td>-</td> </tr> <tr> <td>新庄原子力発電所2号炉</td> <td>0.96</td> <td>66</td> <td>-</td> <td>○</td> <td>-</td> <td>-</td> <td>-</td> <td>-</td> <td>-</td> <td>-</td> <td>-</td> <td>-</td> <td>-</td> <td>-</td> </tr> <tr> <td>新庄原子力発電所2号炉</td> <td>1.57</td> <td>294</td> <td>○</td> <td>○</td> <td>-</td> <td>○</td> <td>-</td> <td>-</td> <td>-</td> <td>-</td> <td>-</td> <td>-</td> <td>-</td> <td>-</td> </tr> <tr> <td>新庄原子力発電所2号炉</td> <td>1.18</td> <td>85</td> <td>-</td> <td>○</td> <td>-</td> <td>○</td> <td>-</td> <td>-</td> <td>-</td> <td>-</td> <td>-</td> <td>-</td> <td>-</td> <td>-</td> </tr> <tr> <td>新庄原子力発電所2号炉</td> <td>0.64</td> <td>85</td> <td>-</td> <td>○</td> <td>-</td> <td>○</td> <td>-</td> <td>-</td> <td>-</td> <td>-</td> <td>-</td> <td>-</td> <td>-</td> <td>-</td> </tr> <tr> <td>新庄原子力発電所2号炉</td> <td>0.64</td> <td>95</td> <td>-</td> <td>○</td> <td>-</td> <td>-</td> <td>-</td> <td>-</td> <td>-</td> <td>-</td> <td>-</td> <td>-</td> <td>-</td> <td>-</td> </tr> <tr> <td>新庄原子力発電所2号炉</td> <td>0.96</td> <td>85</td> <td>-</td> <td>○</td> <td>-</td> <td>-</td> <td>-</td> <td>-</td> <td>-</td> <td>-</td> <td>-</td> <td>-</td> <td>-</td> <td>-</td> </tr> </tbody> </table> <p>※1 当該系統の運転時間が短いため、低エネルギー配管に分類する ※2 原燃物処理エリアのみ ※3 機水側給水系統の給水量で考慮する ※4 休止状態であり無有本なし ※5 CS1エリア：機水貯蔵タンクエリア ※6 LOTエリア：機油タンクエリア</p>	系統	設計条件		分類		設置エリア										静圧(MPa)	最高使用温度(℃)	高エネ	低エネ	原子炉設置		炉内設置		タービン設置		補助ボイラー設置	機水ポンプ室	CS1エリア	LOTエリア	原子炉種	付属機	付属機	付属機	タービン	管理	新庄原子力発電所2号炉	0.78	50	-	○	-	○	-	-	-	-	-	○	-	-	新庄原子力発電所2号炉	2.55	294	○	-	-	-	-	-	-	-	-	-	-	-	新庄原子力発電所2号炉	3.43	300	○	-	-	-	-	-	-	-	-	-	-	-	新庄原子力発電所2号炉	0.96	66	-	○	-	-	-	-	-	-	-	-	-	-	新庄原子力発電所2号炉	1.57	294	○	○	-	○	-	-	-	-	-	-	-	-	新庄原子力発電所2号炉	1.18	85	-	○	-	○	-	-	-	-	-	-	-	-	新庄原子力発電所2号炉	0.64	85	-	○	-	○	-	-	-	-	-	-	-	-	新庄原子力発電所2号炉	0.64	95	-	○	-	-	-	-	-	-	-	-	-	-	新庄原子力発電所2号炉	0.96	85	-	○	-	-	-	-	-	-	-	-	-	-		<p>【女川】</p> <p>記載表現の相違 設計方針の相違</p> <p>・表1において、泊は高エネルギー配管、低エネルギー配管の分類については、溢水ガイドに記載のとおり、「運転圧力」、「運転温度」を用いている。（大阪、高浜、美浜と同様）</p> <p>・プラントの相違による、建屋名称、系統名の相違。</p>
系統	設計条件		分類		設置エリア																																																																																																																																																																								
	静圧(MPa)		最高使用温度(℃)	高エネ	低エネ	原子炉設置		炉内設置		タービン設置		補助ボイラー設置	機水ポンプ室	CS1エリア	LOTエリア																																																																																																																																																														
		原子炉種				付属機	付属機	付属機	タービン	管理																																																																																																																																																																			
新庄原子力発電所2号炉	0.78	50	-	○	-	○	-	-	-	-	-	○	-	-																																																																																																																																																															
新庄原子力発電所2号炉	2.55	294	○	-	-	-	-	-	-	-	-	-	-	-																																																																																																																																																															
新庄原子力発電所2号炉	3.43	300	○	-	-	-	-	-	-	-	-	-	-	-																																																																																																																																																															
新庄原子力発電所2号炉	0.96	66	-	○	-	-	-	-	-	-	-	-	-	-																																																																																																																																																															
新庄原子力発電所2号炉	1.57	294	○	○	-	○	-	-	-	-	-	-	-	-																																																																																																																																																															
新庄原子力発電所2号炉	1.18	85	-	○	-	○	-	-	-	-	-	-	-	-																																																																																																																																																															
新庄原子力発電所2号炉	0.64	85	-	○	-	○	-	-	-	-	-	-	-	-																																																																																																																																																															
新庄原子力発電所2号炉	0.64	95	-	○	-	-	-	-	-	-	-	-	-	-																																																																																																																																																															
新庄原子力発電所2号炉	0.96	85	-	○	-	-	-	-	-	-	-	-	-	-																																																																																																																																																															

赤字：設備、運用又は体制の相違（設計方針の相違）
 青字：記載箇所又は記載内容の相違（記載方針の相違）
 緑字：記載表現、設備名称の相違（実質的な相違なし）

大阪発電所3/4号炉	女川原子力発電所2号炉	泊発電所3号炉	相違理由																																																																																																																																																																																					
	<p>表1 低エネルギー配管・高エネルギー配管の分類と設置エリア (5/6)</p> <table border="1"> <thead> <tr> <th rowspan="3">系統</th> <th colspan="2">設計条件</th> <th colspan="2">分類</th> <th colspan="6">設置エリア</th> </tr> <tr> <th rowspan="2">機軸使用 圧力 (MPa)</th> <th rowspan="2">最高使用 温度(℃)</th> <th rowspan="2">高エネ</th> <th rowspan="2">低エネ</th> <th colspan="2">原子炉建屋</th> <th colspan="2">タービン 建屋</th> <th rowspan="2">補助 ボイラー 建屋</th> <th rowspan="2">機軸 ポンプ 室</th> <th rowspan="2">CSTエ リア 05</th> <th rowspan="2">LOTエ リア 06</th> </tr> <tr> <th>原子炉種</th> <th>付属種</th> <th>付属種 (専断防犯 管理エリア)</th> <th>設備 種</th> <th>設備 種</th> </tr> </thead> <tbody> <tr> <td>高圧炉心スプレイス タービンセル発電設備 機軸排水</td> <td>0.98</td> <td>85</td> <td>-</td> <td>○</td> <td>-</td> <td>○</td> <td>-</td> <td>-</td> <td>-</td> <td>-</td> <td>-</td> <td>-</td> </tr> <tr> <td>非常用ディーゼル型 緊急冷却材送込</td> <td>0.59</td> <td>45</td> <td>-</td> <td>○</td> <td>○</td> <td>-</td> <td>-</td> <td>-</td> <td>-</td> <td>-</td> <td>-</td> <td>-</td> </tr> <tr> <td>高圧炉心スプレイス タービンセル発電設備 燃料送込</td> <td>0.95</td> <td>45</td> <td>-</td> <td>○</td> <td>-</td> <td>○</td> <td>-</td> <td>-</td> <td>-</td> <td>-</td> <td>-</td> <td>○</td> </tr> <tr> <td>非常用ディーゼル型 緊急冷却材送込</td> <td>0.95</td> <td>66</td> <td>-</td> <td>○</td> <td>○</td> <td>-</td> <td>-</td> <td>-</td> <td>-</td> <td>-</td> <td>-</td> <td>○</td> </tr> <tr> <td>高圧炉心スプレイス タービンセル発電設備 燃料送込</td> <td>0.98</td> <td>66</td> <td>-</td> <td>○</td> <td>○</td> <td>-</td> <td>-</td> <td>-</td> <td>-</td> <td>-</td> <td>-</td> <td>○</td> </tr> <tr> <td rowspan="3">タービン機軸排水</td> <td>2.16</td> <td>79</td> <td>○</td> <td>-</td> <td>-</td> <td>-</td> <td>-</td> <td>-</td> <td>-</td> <td>-</td> <td>-</td> <td>-</td> </tr> <tr> <td>0.38</td> <td>79</td> <td>-</td> <td>○</td> <td>-</td> <td>-</td> <td>-</td> <td>-</td> <td>-</td> <td>-</td> <td>-</td> <td>-</td> </tr> <tr> <td>0.62</td> <td>79</td> <td>-</td> <td>○</td> <td>-</td> <td>-</td> <td>-</td> <td>-</td> <td>-</td> <td>-</td> <td>-</td> <td>-</td> </tr> <tr> <td rowspan="2">高圧機軸排水</td> <td>0.80</td> <td>79</td> <td>-</td> <td>○</td> <td>-</td> <td>-</td> <td>-</td> <td>-</td> <td>-</td> <td>-</td> <td>-</td> <td>-</td> </tr> <tr> <td>0.45</td> <td>79</td> <td>-</td> <td>○</td> <td>-</td> <td>-</td> <td>-</td> <td>-</td> <td>-</td> <td>-</td> <td>-</td> <td>-</td> </tr> <tr> <td>高圧機軸排水</td> <td>13.80</td> <td>70</td> <td>○</td> <td>-</td> <td>-</td> <td>-</td> <td>-</td> <td>-</td> <td>-</td> <td>-</td> <td>-</td> <td>-</td> </tr> <tr> <td>高圧機軸排水</td> <td>0.34</td> <td>70</td> <td>-</td> <td>○</td> <td>-</td> <td>-</td> <td>-</td> <td>-</td> <td>-</td> <td>-</td> <td>-</td> <td>-</td> </tr> </tbody> </table> <p>※1 当該系統の運転時間が短いため、低エネルギー配管に分類する ※2 廢棄物処理エリアのみ ※3 機軸冷却水の排水量で考慮する ※4 休止設備であり保有水なし</p> <p>※5 CSTエリア、機軸貯蔵タンクエリア ※6 LOTエリア、機軸タンクエリア</p>	系統	設計条件		分類		設置エリア						機軸使用 圧力 (MPa)	最高使用 温度(℃)	高エネ	低エネ	原子炉建屋		タービン 建屋		補助 ボイラー 建屋	機軸 ポンプ 室	CSTエ リア 05	LOTエ リア 06	原子炉種	付属種	付属種 (専断防犯 管理エリア)	設備 種	設備 種	高圧炉心スプレイス タービンセル発電設備 機軸排水	0.98	85	-	○	-	○	-	-	-	-	-	-	非常用ディーゼル型 緊急冷却材送込	0.59	45	-	○	○	-	-	-	-	-	-	-	高圧炉心スプレイス タービンセル発電設備 燃料送込	0.95	45	-	○	-	○	-	-	-	-	-	○	非常用ディーゼル型 緊急冷却材送込	0.95	66	-	○	○	-	-	-	-	-	-	○	高圧炉心スプレイス タービンセル発電設備 燃料送込	0.98	66	-	○	○	-	-	-	-	-	-	○	タービン機軸排水	2.16	79	○	-	-	-	-	-	-	-	-	-	0.38	79	-	○	-	-	-	-	-	-	-	-	0.62	79	-	○	-	-	-	-	-	-	-	-	高圧機軸排水	0.80	79	-	○	-	-	-	-	-	-	-	-	0.45	79	-	○	-	-	-	-	-	-	-	-	高圧機軸排水	13.80	70	○	-	-	-	-	-	-	-	-	-	高圧機軸排水	0.34	70	-	○	-	-	-	-	-	-	-	-		<p>【女川】</p> <p>記載表現の相違 設計方針の相違</p> <p>・表1において、泊は高エネルギー配管、低エネルギー配管の分類については、溢水ガイドに記載のとおり、「運転圧力」、「運転温度」を用いている。(大飯、高浜、美浜と同様)</p> <p>・プラントの相違による、建屋名称、系統名の相違。</p>
系統	設計条件		分類		設置エリア																																																																																																																																																																																			
	機軸使用 圧力 (MPa)		最高使用 温度(℃)	高エネ	低エネ	原子炉建屋		タービン 建屋		補助 ボイラー 建屋	機軸 ポンプ 室	CSTエ リア 05	LOTエ リア 06																																																																																																																																																																											
		原子炉種				付属種	付属種 (専断防犯 管理エリア)	設備 種	設備 種																																																																																																																																																																															
高圧炉心スプレイス タービンセル発電設備 機軸排水	0.98	85	-	○	-	○	-	-	-	-	-	-																																																																																																																																																																												
非常用ディーゼル型 緊急冷却材送込	0.59	45	-	○	○	-	-	-	-	-	-	-																																																																																																																																																																												
高圧炉心スプレイス タービンセル発電設備 燃料送込	0.95	45	-	○	-	○	-	-	-	-	-	○																																																																																																																																																																												
非常用ディーゼル型 緊急冷却材送込	0.95	66	-	○	○	-	-	-	-	-	-	○																																																																																																																																																																												
高圧炉心スプレイス タービンセル発電設備 燃料送込	0.98	66	-	○	○	-	-	-	-	-	-	○																																																																																																																																																																												
タービン機軸排水	2.16	79	○	-	-	-	-	-	-	-	-	-																																																																																																																																																																												
	0.38	79	-	○	-	-	-	-	-	-	-	-																																																																																																																																																																												
	0.62	79	-	○	-	-	-	-	-	-	-	-																																																																																																																																																																												
高圧機軸排水	0.80	79	-	○	-	-	-	-	-	-	-	-																																																																																																																																																																												
	0.45	79	-	○	-	-	-	-	-	-	-	-																																																																																																																																																																												
高圧機軸排水	13.80	70	○	-	-	-	-	-	-	-	-	-																																																																																																																																																																												
高圧機軸排水	0.34	70	-	○	-	-	-	-	-	-	-	-																																																																																																																																																																												

赤字：設備、運用又は体制の相違（設計方針の相違）
 青字：記載箇所又は記載内容の相違（記載方針の相違）
 緑字：記載表現、設備名称の相違（実質的な相違なし）

大阪発電所3/4号炉	女川原子力発電所2号炉	泊発電所3号炉	相違理由																																							
<p>補足資料3-2</p> <p>図1のフローによって低エネルギー配管を抽出した結果を表1に示す。また、通常運転時に高エネルギー状態にある運転期間が短時間であるため低エネルギー配管とした系統について、高エネルギー状態にある運転時間割合を評価した結果を表1に示す。</p>	<p>表1 低エネルギー配管・高エネルギー配管の分類と設置エリア (6/6)</p> <table border="1" data-bbox="696 252 857 1145"> <thead> <tr> <th rowspan="3">系統</th> <th colspan="2">設計条件</th> <th colspan="2">分類</th> <th colspan="4">設置エリア</th> </tr> <tr> <th rowspan="2">最高使用圧力(MPa)</th> <th rowspan="2">最高使用温度(℃)</th> <th rowspan="2">高エネ</th> <th rowspan="2">低エネ</th> <th colspan="2">原子炉種別</th> <th colspan="2">タービン種別</th> </tr> <tr> <th>付属種別</th> <th>付属種別</th> <th>管理</th> <th>設置</th> </tr> </thead> <tbody> <tr> <td>事故時排水系</td> <td>0.98</td> <td>66</td> <td>-</td> <td>○</td> <td>○</td> <td>-</td> <td>-</td> <td>-</td> </tr> <tr> <td>炉内用水系</td> <td>0.29</td> <td>70</td> <td>-</td> <td>○</td> <td>○</td> <td>-</td> <td>-</td> <td>-</td> </tr> </tbody> </table> <p>※1 当該系統の運転時間が短いため、低エネルギー配管に分類する ※2 廃棄物処理エリアのみ ※3 廃水側給水系の給水量で考慮する ※4 休止設備であり保有水なし</p> <p>※5 CSTエリア：直水貯蔵タンクエリア ※6 LOTエリア：軽油タンクエリア</p> <p>2. 高エネルギー及び低エネルギー配管の分類について ガイド付録Aには、高エネルギー配管であっても高エネルギー状態にある運転期間が短時間（プラントの通常運転時の1%より小さい）である場合には、低エネルギー配管とすることができるものと定められている。</p>	系統	設計条件		分類		設置エリア				最高使用圧力(MPa)	最高使用温度(℃)	高エネ	低エネ	原子炉種別		タービン種別		付属種別	付属種別	管理	設置	事故時排水系	0.98	66	-	○	○	-	-	-	炉内用水系	0.29	70	-	○	○	-	-	-	<p>2. 高エネルギー及び低エネルギー配管の分類について ガイド付録Aには、高エネルギー配管であっても高エネルギー状態にある運転期間が短時間（プラントの通常運転時の1%より小さい）である場合には、低エネルギー配管とすることができるものと定められている。</p>	<p>【女川】</p> <p>記載表現の相違 設計方針の相違</p> <ul style="list-style-type: none"> 表1において、泊は高エネルギー配管、低エネルギー配管の分類については、溢水ガイドに記載のとおり、「運転圧力」、「運転温度」を用いている。（大阪、高浜、美浜と同様） プラントの相違による、建屋名称、系統名の相違。 <p>【大阪】</p> <p>記載方針の相違</p> <p>女川審査実績を反映し、記載内容を変更した。大阪も高エネルギー配管を低エネルギー配管とすることを確認しており、実施内容について相違はない。</p>
系統	設計条件		分類		設置エリア																																					
	最高使用圧力(MPa)		最高使用温度(℃)	高エネ	低エネ	原子炉種別		タービン種別																																		
		付属種別				付属種別	管理	設置																																		
事故時排水系	0.98	66	-	○	○	-	-	-																																		
炉内用水系	0.29	70	-	○	○	-	-	-																																		

赤字：設備、運用又は体制の相違（設計方針の相違）
 青字：記載箇所又は記載内容の相違（記載方針の相違）
 緑字：記載表現、設備名称の相違（実質的な相違なし）

大阪発電所3/4号炉	女川原子力発電所2号炉	泊発電所3号炉	相違理由																																																																																													
<p>今回、運転している期間が短いことから低エネルギー配管とした6系統について、高エネルギー状態にある運転期間の条件を満足することを確認した結果を表2に示す。</p> <p>本系統については、通常、待機状態であるため、高エネルギー状態にある運転期間はサーベランス及び定期検査中の作業時の試運転を考慮した。なお、残留熱除去系については、定期検査中の停止時冷却モード運転も考慮した。</p> <p>なお、本事項は後段規則での対応が必要となる事項である。（別添2参照）</p>	<p>今回、運転している期間が短いことから低エネルギー配管とした4系統について、高エネルギー状態にある運転期間の条件を満足することを確認した結果を表2に示す。</p> <p>本系統については、通常、待機状態であるため、高エネルギー状態にある運転期間はサーベランス及び定期事業者検査中の作業時の試運転を考慮した。なお、余熱除去系については、定期事業者検査中の冷却運転も考慮した。</p> <p>なお、本事項は後段規則での対応が必要となる事項である。（別添2参照）</p>	<p>今回、運転している期間が短いことから低エネルギー配管とした4系統について、高エネルギー状態にある運転期間の条件を満足することを確認した結果を表2に示す。</p> <p>本系統については、通常、待機状態であるため、高エネルギー状態にある運転期間はサーベランス及び定期事業者検査中の作業時の試運転を考慮した。なお、余熱除去系については、定期事業者検査中の冷却運転も考慮した。</p> <p>なお、本事項は後段規則での対応が必要となる事項である。（別添2参照）</p>	<p>【女川】 <u>設計方針の相違</u> プラント設計による相違 <u>記載表現の相違</u> BWRは残留熱除去系の運転モードの1つとして原子炉停止後の崩壊熱を除去する「停止時冷却モード」がある。PWRではそのような運転モード名称はないため、定期事業者検査中の「冷却」とする。</p>																																																																																													
<p>表1 低エネルギー配管を有する系統の抽出結果</p>	<p>表2 高エネルギー状態の運転期間割合算出結果</p>	<p>表2 高エネルギー状態の運転期間割合算出結果</p>	<p>【女川】 <u>設計方針の相違</u></p>																																																																																													
<table border="1"> <thead> <tr> <th>系統</th> <th>対象範囲における使用条件</th> <th>運転時間割合※1</th> </tr> </thead> <tbody> <tr> <td>原子炉補機冷却系</td> <td>運転圧力：約 0.88～0.94MPa 運転温度：約 14～32℃</td> <td>—</td> </tr> <tr> <td>格納容器スプレイ系※1</td> <td>運転圧力：約 2.9MPa 運転温度：約 22～29℃</td> <td><1%</td> </tr> <tr> <td>化学体積制御系</td> <td>運転圧力：約 0.14MPa 運転温度：約 28～39℃</td> <td>—</td> </tr> <tr> <td>冷水系</td> <td>運転圧力：約 0.85MPa 運転温度：約 5℃</td> <td>—</td> </tr> <tr> <td>1次系洗浄水系</td> <td>運転圧力：約 1.0MPa 運転温度：約 27℃</td> <td>—</td> </tr> <tr> <td>1次系放射性ドレン系（機器ドレン）</td> <td>運転圧力： 大気圧 運転温度：約 27℃</td> <td>—</td> </tr> <tr> <td>1次系放射性ドレン系（床ドレン）</td> <td>運転圧力： 大気圧 運転温度：約 27℃</td> <td>—</td> </tr> <tr> <td>消火水系</td> <td>運転圧力：約 1.0MPa 運転温度：約 27℃</td> <td>—</td> </tr> <tr> <td>1次系補給水系</td> <td>運転圧力：約 1.1MPa 運転温度：約 27℃</td> <td>—</td> </tr> <tr> <td>余熱除去系※1</td> <td>運転圧力：約 2.9MPa以下 運転温度：約 177℃以下</td> <td><1%</td> </tr> <tr> <td>燃料取替用水系</td> <td>運転圧力：約 0.8MPa 運転温度：約 19～36℃</td> <td>—</td> </tr> <tr> <td>燃料ピット冷却浄化系</td> <td>運転圧力：約 0.8MPa 運転温度：約 19～36℃</td> <td>—</td> </tr> <tr> <td>安全注入系※1</td> <td>運転圧力：約 15.2MPa 運転温度：約 22～29℃</td> <td><1%</td> </tr> <tr> <td>海水系</td> <td>運転圧力：約 0.45MPa 運転温度：約 10～30℃</td> <td>—</td> </tr> <tr> <td>液体廃棄物処理系</td> <td>運転圧力：約 19～47kPa 運転温度：約 105～111℃</td> <td>—</td> </tr> <tr> <td>固体廃棄物処理系</td> <td>運転圧力： 大気圧 運転温度：約 27℃</td> <td>—</td> </tr> <tr> <td>補助給水系※1</td> <td>運転圧力：約 10.7～12.1MPa 運転温度：約 21～29℃</td> <td><1%</td> </tr> </tbody> </table> <p>※1 通常運転時に高エネルギー状態にある運転期間が短時間であるため低エネルギー配管とした系統</p> <p>※2 運転時間割合のうち、通常運転時の運転時間については、毎月のサーベランスの運転時間実績で評価した。格納容器スプレイ系、安全注入系及び補助給水系は事故時に動作する系統であり、定検時の調整運転等を考慮しても通常運転時に比べ十分短く、また、余熱除去ポンプの定検期間の運転時間も十分短いため、サーベランスで代表しても評価に影響しない。</p>	系統	対象範囲における使用条件	運転時間割合※1	原子炉補機冷却系	運転圧力：約 0.88～0.94MPa 運転温度：約 14～32℃	—	格納容器スプレイ系※1	運転圧力：約 2.9MPa 運転温度：約 22～29℃	<1%	化学体積制御系	運転圧力：約 0.14MPa 運転温度：約 28～39℃	—	冷水系	運転圧力：約 0.85MPa 運転温度：約 5℃	—	1次系洗浄水系	運転圧力：約 1.0MPa 運転温度：約 27℃	—	1次系放射性ドレン系（機器ドレン）	運転圧力： 大気圧 運転温度：約 27℃	—	1次系放射性ドレン系（床ドレン）	運転圧力： 大気圧 運転温度：約 27℃	—	消火水系	運転圧力：約 1.0MPa 運転温度：約 27℃	—	1次系補給水系	運転圧力：約 1.1MPa 運転温度：約 27℃	—	余熱除去系※1	運転圧力：約 2.9MPa以下 運転温度：約 177℃以下	<1%	燃料取替用水系	運転圧力：約 0.8MPa 運転温度：約 19～36℃	—	燃料ピット冷却浄化系	運転圧力：約 0.8MPa 運転温度：約 19～36℃	—	安全注入系※1	運転圧力：約 15.2MPa 運転温度：約 22～29℃	<1%	海水系	運転圧力：約 0.45MPa 運転温度：約 10～30℃	—	液体廃棄物処理系	運転圧力：約 19～47kPa 運転温度：約 105～111℃	—	固体廃棄物処理系	運転圧力： 大気圧 運転温度：約 27℃	—	補助給水系※1	運転圧力：約 10.7～12.1MPa 運転温度：約 21～29℃	<1%	<table border="1"> <thead> <tr> <th>系統</th> <th>運転時間割合</th> <th>計算式 (X^{※1}/Y^{※2})</th> </tr> </thead> <tbody> <tr> <td>ほう酸水注入系</td> <td>(A):0.05 % (B):0.05 %</td> <td>(A):(63 h)/(133921 h)=0.05 % < 1% (B):(63 h)/(133921 h)=0.05 % < 1%</td> </tr> <tr> <td>残留熱除去系</td> <td>(A):0.03 % (B):0.02 % (C):0.02 %</td> <td>(A):(28 h)/(133921 h)=0.03 % < 1% (B):(23 h)/(133921 h)=0.02 % < 1% (C):(14 h)/(133921 h)=0.02 % < 1%</td> </tr> <tr> <td>低圧炉心スプレイ系</td> <td>0.10 %</td> <td>(133 h)/(133921 h)=0.10 % < 1%</td> </tr> <tr> <td>高圧炉心スプレイ系</td> <td>0.15 %</td> <td>(189 h)/(133921 h)=0.15 % < 1%</td> </tr> <tr> <td>原子炉隔離時冷却系</td> <td>0.08 %</td> <td>(99 h)/(133921 h)=0.08 % < 1%</td> </tr> <tr> <td>加熱蒸気及び復水戻り系(原子炉隔離時冷却系タービンテストライン)</td> <td>0.01 %</td> <td>(3 h)/(133921 h)=0.01 % < 1%</td> </tr> </tbody> </table> <p>※1 高エネルギー状態にある運転期間（時間）</p> <p>※2 プラント運転開始（平成7年7月）～第11回定検終了（平成22年11月）</p>	系統	運転時間割合	計算式 (X ^{※1} /Y ^{※2})	ほう酸水注入系	(A):0.05 % (B):0.05 %	(A):(63 h)/(133921 h)=0.05 % < 1% (B):(63 h)/(133921 h)=0.05 % < 1%	残留熱除去系	(A):0.03 % (B):0.02 % (C):0.02 %	(A):(28 h)/(133921 h)=0.03 % < 1% (B):(23 h)/(133921 h)=0.02 % < 1% (C):(14 h)/(133921 h)=0.02 % < 1%	低圧炉心スプレイ系	0.10 %	(133 h)/(133921 h)=0.10 % < 1%	高圧炉心スプレイ系	0.15 %	(189 h)/(133921 h)=0.15 % < 1%	原子炉隔離時冷却系	0.08 %	(99 h)/(133921 h)=0.08 % < 1%	加熱蒸気及び復水戻り系(原子炉隔離時冷却系タービンテストライン)	0.01 %	(3 h)/(133921 h)=0.01 % < 1%	<table border="1"> <thead> <tr> <th>系統</th> <th>運転時間割合</th> <th>計算式 (X^{※1}/Y^{※2})</th> </tr> </thead> <tbody> <tr> <td>余熱除去系</td> <td>(A):0.85 % (B):0.85 %</td> <td>(A):(176h)/(20,760h)=0.85%<1% (B):(176h)/(20,760h)=0.85%<1%</td> </tr> <tr> <td>原子炉格納容器スプレイ系</td> <td>(A):0.03 % (B):0.03 %</td> <td>(A):(4.2h)/(20,760h)=0.03%<1% (B):(4.2h)/(20,760h)=0.03%<1%</td> </tr> <tr> <td>補助給水系 (電動補助給水ポンプ)</td> <td>(A):0.11 % (B):0.03 %</td> <td>(A):(22.5h)/(20,760h)=0.11%<1% (B):(4.5h)/(20,760h)=0.03%<1%</td> </tr> <tr> <td>補助給水系 (タービン動補助給水ポンプ)</td> <td>0.05%</td> <td>(9h)/(20,760h)=0.05%<1%</td> </tr> <tr> <td>安全注入系</td> <td>(A):0.03 % (B):0.03 %</td> <td>(A):(4.3h)/(20,760h)=0.03%<1% (B):(4.3h)/(20,760h)=0.03%<1%</td> </tr> </tbody> </table> <p>※1 高エネルギー状態にある運転期間（時間）</p> <p>※2 プラント運転開始（平成21年12月）～第2回定検終了（平成24年5月）</p>	系統	運転時間割合	計算式 (X ^{※1} /Y ^{※2})	余熱除去系	(A):0.85 % (B):0.85 %	(A):(176h)/(20,760h)=0.85%<1% (B):(176h)/(20,760h)=0.85%<1%	原子炉格納容器スプレイ系	(A):0.03 % (B):0.03 %	(A):(4.2h)/(20,760h)=0.03%<1% (B):(4.2h)/(20,760h)=0.03%<1%	補助給水系 (電動補助給水ポンプ)	(A):0.11 % (B):0.03 %	(A):(22.5h)/(20,760h)=0.11%<1% (B):(4.5h)/(20,760h)=0.03%<1%	補助給水系 (タービン動補助給水ポンプ)	0.05%	(9h)/(20,760h)=0.05%<1%	安全注入系	(A):0.03 % (B):0.03 %	(A):(4.3h)/(20,760h)=0.03%<1% (B):(4.3h)/(20,760h)=0.03%<1%	<p>【女川】 <u>設計方針の相違</u> ・プラント設計による系統の相違 ・運転期間が異なることによる評価条件の相違</p> <p>【大阪】 <u>記載方針の相違</u> 女川審査実績を反映した表の記載とし、高エネルギー状態の計算に用いる時間を記載した。</p>
系統	対象範囲における使用条件	運転時間割合※1																																																																																														
原子炉補機冷却系	運転圧力：約 0.88～0.94MPa 運転温度：約 14～32℃	—																																																																																														
格納容器スプレイ系※1	運転圧力：約 2.9MPa 運転温度：約 22～29℃	<1%																																																																																														
化学体積制御系	運転圧力：約 0.14MPa 運転温度：約 28～39℃	—																																																																																														
冷水系	運転圧力：約 0.85MPa 運転温度：約 5℃	—																																																																																														
1次系洗浄水系	運転圧力：約 1.0MPa 運転温度：約 27℃	—																																																																																														
1次系放射性ドレン系（機器ドレン）	運転圧力： 大気圧 運転温度：約 27℃	—																																																																																														
1次系放射性ドレン系（床ドレン）	運転圧力： 大気圧 運転温度：約 27℃	—																																																																																														
消火水系	運転圧力：約 1.0MPa 運転温度：約 27℃	—																																																																																														
1次系補給水系	運転圧力：約 1.1MPa 運転温度：約 27℃	—																																																																																														
余熱除去系※1	運転圧力：約 2.9MPa以下 運転温度：約 177℃以下	<1%																																																																																														
燃料取替用水系	運転圧力：約 0.8MPa 運転温度：約 19～36℃	—																																																																																														
燃料ピット冷却浄化系	運転圧力：約 0.8MPa 運転温度：約 19～36℃	—																																																																																														
安全注入系※1	運転圧力：約 15.2MPa 運転温度：約 22～29℃	<1%																																																																																														
海水系	運転圧力：約 0.45MPa 運転温度：約 10～30℃	—																																																																																														
液体廃棄物処理系	運転圧力：約 19～47kPa 運転温度：約 105～111℃	—																																																																																														
固体廃棄物処理系	運転圧力： 大気圧 運転温度：約 27℃	—																																																																																														
補助給水系※1	運転圧力：約 10.7～12.1MPa 運転温度：約 21～29℃	<1%																																																																																														
系統	運転時間割合	計算式 (X ^{※1} /Y ^{※2})																																																																																														
ほう酸水注入系	(A):0.05 % (B):0.05 %	(A):(63 h)/(133921 h)=0.05 % < 1% (B):(63 h)/(133921 h)=0.05 % < 1%																																																																																														
残留熱除去系	(A):0.03 % (B):0.02 % (C):0.02 %	(A):(28 h)/(133921 h)=0.03 % < 1% (B):(23 h)/(133921 h)=0.02 % < 1% (C):(14 h)/(133921 h)=0.02 % < 1%																																																																																														
低圧炉心スプレイ系	0.10 %	(133 h)/(133921 h)=0.10 % < 1%																																																																																														
高圧炉心スプレイ系	0.15 %	(189 h)/(133921 h)=0.15 % < 1%																																																																																														
原子炉隔離時冷却系	0.08 %	(99 h)/(133921 h)=0.08 % < 1%																																																																																														
加熱蒸気及び復水戻り系(原子炉隔離時冷却系タービンテストライン)	0.01 %	(3 h)/(133921 h)=0.01 % < 1%																																																																																														
系統	運転時間割合	計算式 (X ^{※1} /Y ^{※2})																																																																																														
余熱除去系	(A):0.85 % (B):0.85 %	(A):(176h)/(20,760h)=0.85%<1% (B):(176h)/(20,760h)=0.85%<1%																																																																																														
原子炉格納容器スプレイ系	(A):0.03 % (B):0.03 %	(A):(4.2h)/(20,760h)=0.03%<1% (B):(4.2h)/(20,760h)=0.03%<1%																																																																																														
補助給水系 (電動補助給水ポンプ)	(A):0.11 % (B):0.03 %	(A):(22.5h)/(20,760h)=0.11%<1% (B):(4.5h)/(20,760h)=0.03%<1%																																																																																														
補助給水系 (タービン動補助給水ポンプ)	0.05%	(9h)/(20,760h)=0.05%<1%																																																																																														
安全注入系	(A):0.03 % (B):0.03 %	(A):(4.3h)/(20,760h)=0.03%<1% (B):(4.3h)/(20,760h)=0.03%<1%																																																																																														

赤字：設備、運用又は体制の相違（設計方針の相違）
 青字：記載箇所又は記載内容の相違（記載方針の相違）
 緑字：記載表現、設備名称の相違（実質的な相違なし）

大阪発電所3/4号炉	女川原子力発電所2号炉	泊発電所3号炉	相違理由
<p style="text-align: right;">補足資料 3-3（別紙1）</p> <p>高エネルギー配管（補助蒸気供給配管）の破損形状の設定</p> <p>1. 概要</p> <p>高エネルギー配管のうち補助蒸気供給配管について溢水ガイド附属書Aの高エネルギー配管の評価対象（25A以上）に対し、ターミナルエンドは完全全周破断、ターミナルエンド以外（一般部）は、許容応力の0.8倍又は0.4倍に応じた破損形状とする旨の記載にしたがって評価している。本資料は補助蒸気供給配管の応力評価の手法、結果についてとりまとめたものである。</p>	<p style="text-align: right;">添付資料 14</p> <p>高エネルギー配管の想定破損除外について</p> <p>1. 評価対象配管</p> <p>想定破損除外の適用（応力評価）を実施する対象配管を表1に示す。</p>	<p style="text-align: right;">添付資料 13</p> <p>高エネルギー配管の想定破損除外又は貫通クラックについて</p> <p>1. 評価対象配管</p> <p>想定破損除外又は貫通クラックの適用（応力評価）を実施する対象配管を表1に示す。</p>	<p>【女川】</p> <p>記載表現の相違 設計方針の相違</p> <p>泊は高エネルギー配管に対して、貫通クラックを適用している系統がある。（大阪、高浜、美浜、玄海、川内、伊方と同様）</p> <p>【大阪】</p> <p>記載方針の相違</p> <p>女川の審査実績を反映し、応力評価を実施する配管を抽出した上で応力評価結果を記載する方針とする。</p> <p>記載表現の相違</p>

赤字：設備、運用又は体制の相違（設計方針の相違）
 青字：記載箇所又は記載内容の相違（記載方針の相違）
 緑字：記載表現、設備名称の相違（実質的な相違なし）

大阪発電所3/4号炉	女川原子力発電所2号炉	泊発電所3号炉	相違理由																																																																																																							
<p>補足資料3-3</p> <p>表1 想定破損の応力評価に基づく破損形状の結果（一般部）</p> <table border="1"> <thead> <tr> <th>系統名</th> <th>応力評価</th> <th>破損形状</th> <th>備考</th> </tr> </thead> <tbody> <tr> <td>化学体積制御系</td> <td rowspan="5">実施なし</td> <td rowspan="5">完全全周破断</td> <td rowspan="5"></td> </tr> <tr> <td>主蒸気系</td> </tr> <tr> <td>主給水系</td> </tr> <tr> <td>蒸気発生器ブローダウン系</td> </tr> <tr> <td>補助給水系</td> </tr> <tr> <td>補助蒸気系</td> <td>実施あり</td> <td>貫通クラック*</td> <td></td> </tr> </tbody> </table> <p>※ 応力評価を実施し、評価結果は許容応力(0.8Sn)以下であった</p>	系統名	応力評価	破損形状	備考	化学体積制御系	実施なし	完全全周破断		主蒸気系	主給水系	蒸気発生器ブローダウン系	補助給水系	補助蒸気系	実施あり	貫通クラック*		<p>表1 高エネルギー配管の想定破損除外を適用する対象配管</p> <table border="1"> <thead> <tr> <th rowspan="2">設置エリア</th> <th rowspan="2">溢水防護区画番号</th> <th rowspan="2">対象系統</th> <th colspan="2">対象配管</th> </tr> <tr> <th>ライン番号</th> <th>材質</th> </tr> </thead> <tbody> <tr> <td rowspan="18">原子炉建屋 原子炉棟</td> <td rowspan="2">R-1F-5</td> <td rowspan="2">H S</td> <td>200A-HS-100-1</td> <td>STPT38</td> </tr> <tr> <td>50A-HS-4</td> <td>STPT38</td> </tr> <tr> <td rowspan="2">R-1F-12</td> <td rowspan="2">H S</td> <td>50A-HS-4</td> <td>STPT38</td> </tr> <tr> <td>100A-HS-109</td> <td>STPT38</td> </tr> <tr> <td rowspan="2">R-B1F-1</td> <td rowspan="2">H S</td> <td>40A-HS-110</td> <td>STPT38</td> </tr> <tr> <td>200A-HSCR-152-2</td> <td>STPA23</td> </tr> <tr> <td rowspan="10">原子炉建屋 原子炉棟</td> <td rowspan="2"></td> <td rowspan="2">H S C R</td> <td>25A-HSCR-220</td> <td>STPA23</td> </tr> <tr> <td>100A-HS-109</td> <td>STPT38</td> </tr> <tr> <td rowspan="8">R-B2F-1</td> <td rowspan="8">H S C R</td> <td>40A-HS-110</td> <td>STPT38</td> </tr> <tr> <td>200A-HSCR-152-2</td> <td></td> </tr> <tr> <td>200A-HSCR-153</td> <td></td> </tr> <tr> <td>100A-HSCR-152-3</td> <td></td> </tr> <tr> <td>30A-HSCR-452-1</td> <td>STPA23</td> </tr> <tr> <td>40A-HSCR-208</td> <td>STPT38</td> </tr> <tr> <td>25A-HSCR-159</td> <td></td> </tr> <tr> <td>25A-HSCR-206</td> <td></td> </tr> <tr> <td>20A-HSCR-466-1</td> <td></td> </tr> <tr> <td>R-B2F-5</td> <td>H S</td> <td>40A-HS-110</td> <td>STPT38</td> </tr> <tr> <td rowspan="2">R-B3F-2</td> <td rowspan="2">H S</td> <td>100A-HS-109</td> <td>STPT38</td> </tr> <tr> <td>20A-HS-562-1</td> <td>STS42</td> </tr> <tr> <td rowspan="2">制御建屋</td> <td rowspan="2">C-1F-1</td> <td rowspan="2">H S</td> <td>250A-HS-3</td> <td>STPT38</td> </tr> <tr> <td>C-1F-3</td> <td>H S</td> <td>250A-HS-3</td> <td>STPT38</td> </tr> </tbody> </table>	設置エリア	溢水防護区画番号	対象系統	対象配管		ライン番号	材質	原子炉建屋 原子炉棟	R-1F-5	H S	200A-HS-100-1	STPT38	50A-HS-4	STPT38	R-1F-12	H S	50A-HS-4	STPT38	100A-HS-109	STPT38	R-B1F-1	H S	40A-HS-110	STPT38	200A-HSCR-152-2	STPA23	原子炉建屋 原子炉棟		H S C R	25A-HSCR-220	STPA23	100A-HS-109	STPT38	R-B2F-1	H S C R	40A-HS-110	STPT38	200A-HSCR-152-2		200A-HSCR-153		100A-HSCR-152-3		30A-HSCR-452-1	STPA23	40A-HSCR-208	STPT38	25A-HSCR-159		25A-HSCR-206		20A-HSCR-466-1		R-B2F-5	H S	40A-HS-110	STPT38	R-B3F-2	H S	100A-HS-109	STPT38	20A-HS-562-1	STS42	制御建屋	C-1F-1	H S	250A-HS-3	STPT38	C-1F-3	H S	250A-HS-3	STPT38	<p>表1 高エネルギー配管の想定破損除外又は貫通クラックを適用する対象配管</p> <table border="1"> <thead> <tr> <th>設置エリア</th> <th>対象配管</th> <th>材質</th> </tr> </thead> <tbody> <tr> <td rowspan="2">原子炉建屋 原子炉補助建屋</td> <td rowspan="2">補助蒸気系配管*</td> <td>STFG370</td> </tr> <tr> <td>STPT370</td> </tr> <tr> <td rowspan="2">原子炉建屋 原子炉補助建屋</td> <td rowspan="2">蒸気発生器ブローダウン系 (主蒸気管室外)配管*</td> <td>STPT370</td> </tr> <tr> <td>STPT370</td> </tr> <tr> <td rowspan="2">原子炉建屋 原子炉補助建屋</td> <td rowspan="2">主蒸気系(主蒸気管室外)配管*</td> <td>STPT370</td> </tr> <tr> <td>STPT370</td> </tr> </tbody> </table> <p>※1 蒸気影響範囲のみ応力評価を実施。</p>	設置エリア	対象配管	材質	原子炉建屋 原子炉補助建屋	補助蒸気系配管*	STFG370	STPT370	原子炉建屋 原子炉補助建屋	蒸気発生器ブローダウン系 (主蒸気管室外)配管*	STPT370	STPT370	原子炉建屋 原子炉補助建屋	主蒸気系(主蒸気管室外)配管*	STPT370	STPT370	<p>【女川】</p> <p><u>設計方針の相違</u></p> <ul style="list-style-type: none"> ・泊は高エネルギー配管に対して、貫通クラックを適用している系統がある。(大飯、高浜、美浜、玄海、川内、伊方と同様) ・建屋名称、対象系統、材質の相違。 ・女川では、想定破損除外のために3次元はりモデル解析を実施する配管を抽出し、当該配管の溢水防護区画番号及びライン番号を記載している。 ・泊では、原則として標準支持間隔法を用いた応力評価を実施するため個別配管の溢水防護区画番号及びライン番号を特定する必要はない。(大飯と同様) ・泊では、高エネルギー配管の蒸気影響範囲のみに絞って応力評価を実施している。 <p>【大飯】</p> <p><u>設計方針の相違</u></p> <p>大飯では想定破損除外を適用している高エネルギー配管はない。</p> <p><u>記載方針の相違</u></p> <p>女川の審査実績を反映し、応力評価を実施する配管を抽出した上で応力評価結果を抽出する記載方針とする。</p>
系統名	応力評価	破損形状	備考																																																																																																							
化学体積制御系	実施なし	完全全周破断																																																																																																								
主蒸気系																																																																																																										
主給水系																																																																																																										
蒸気発生器ブローダウン系																																																																																																										
補助給水系																																																																																																										
補助蒸気系	実施あり	貫通クラック*																																																																																																								
設置エリア	溢水防護区画番号	対象系統	対象配管																																																																																																							
			ライン番号	材質																																																																																																						
原子炉建屋 原子炉棟	R-1F-5	H S	200A-HS-100-1	STPT38																																																																																																						
			50A-HS-4	STPT38																																																																																																						
	R-1F-12	H S	50A-HS-4	STPT38																																																																																																						
			100A-HS-109	STPT38																																																																																																						
	R-B1F-1	H S	40A-HS-110	STPT38																																																																																																						
			200A-HSCR-152-2	STPA23																																																																																																						
	原子炉建屋 原子炉棟		H S C R	25A-HSCR-220	STPA23																																																																																																					
				100A-HS-109	STPT38																																																																																																					
		R-B2F-1	H S C R	40A-HS-110	STPT38																																																																																																					
				200A-HSCR-152-2																																																																																																						
				200A-HSCR-153																																																																																																						
				100A-HSCR-152-3																																																																																																						
				30A-HSCR-452-1	STPA23																																																																																																					
				40A-HSCR-208	STPT38																																																																																																					
				25A-HSCR-159																																																																																																						
				25A-HSCR-206																																																																																																						
	20A-HSCR-466-1																																																																																																									
	R-B2F-5	H S	40A-HS-110	STPT38																																																																																																						
R-B3F-2	H S	100A-HS-109	STPT38																																																																																																							
		20A-HS-562-1	STS42																																																																																																							
制御建屋	C-1F-1	H S	250A-HS-3	STPT38																																																																																																						
			C-1F-3	H S	250A-HS-3	STPT38																																																																																																				
設置エリア	対象配管	材質																																																																																																								
原子炉建屋 原子炉補助建屋	補助蒸気系配管*	STFG370																																																																																																								
		STPT370																																																																																																								
原子炉建屋 原子炉補助建屋	蒸気発生器ブローダウン系 (主蒸気管室外)配管*	STPT370																																																																																																								
		STPT370																																																																																																								
原子炉建屋 原子炉補助建屋	主蒸気系(主蒸気管室外)配管*	STPT370																																																																																																								
		STPT370																																																																																																								

赤字：設備、運用又は体制の相違（設計方針の相違）
 青字：記載箇所又は記載内容の相違（記載方針の相違）
 緑字：記載表現、設備名称の相違（実質的な相違なし）

大阪発電所3/4号炉	女川原子力発電所2号炉	泊発電所3号炉	相違理由
<p style="text-align: right;">補足資料3-3（別紙1）</p> <p>3.1. 評価方法</p> <p>溢水ガイド附属書Aにしたがい、供用状態A、B及び(1/3)Sd地震荷重に対して設計・建設規格 PPC-3530(1)b. の計算式により S_n（一次応力+二次応力）を算出し、設計・建設規格 PPC-3530(1)d. の計算式により求めた S_a（許容応力）との比較により破損形状を設定する。一次応力に対する支持間隔の算出については、標準支持間隔のモデルによるものとし（詳細は、「別紙3 標準支持間隔法による一次応力評価」を参照）、必要に応じて3次元はりモデル解析を行う。二次応力である熱応力は保守的な値として建設工認時における限度値の100MPaを一律に用いる。</p>	<p>2. 評価方法</p> <p>加熱蒸気及び復水戻り系は非安全系の配管であることから、溢水ガイド附属書Aのクラス2、3又は非安全系の配管に適用される計算式により応力評価を実施し、評価条件を満足することを確認する。</p> <p>供用状態A、B及び(1/3) Sd地震荷重に対して設計・建設規格 PPC-3530(1)b. の計算式により計算した（一次応力+二次応力）S_nが、設計・建設規格 PPC-3530(1)d. の計算式により求めた許容応力 S_a の0.4倍以下であることを確認する。</p>	<p>2. 評価方法</p> <p>補助蒸気系、蒸気発生器ブローダウン系（主蒸気管室外）及び主蒸気系（主蒸気管室外）は非安全系の配管であることから、溢水ガイド附属書Aのクラス2、3又は非安全系の配管に適用される計算式により応力評価を実施し、評価条件を満足することを確認する。</p> <p>供用状態A、B及び(1/3) Sd地震荷重に対して設計・建設規格 PPC-3530(1)b. の計算式により計算した（一次応力+二次応力）S_nと、設計・建設規格 PPC-3530(1)d. の計算式により求めた許容応力 S_a との比較により破断形状を設定する。一次応力に対する支持間隔の算出については、標準支持間隔のモデルによるものとし（詳細は、「別紙 標準支持間隔法による一次応力評価」を参照）、必要に応じて3次元はりモデル解析を行う。二次応力である熱応力は保守的な値として建設工認時における限度値の100MPaを一律に用いる。</p>	<p>【女川】</p> <p>設計方針の相違 プラント設計による系統の相違</p> <p>【女川】</p> <p>設計方針の相違</p> <p>・女川はS_n（一次応力+二次応力）が許容応力S_aの0.4倍以下であれば想定破損除外を適用し、それ以外は完全全周破断を想定することになっているが、泊はそれに加えて、許容応力S_aの0.4倍を超え0.8倍以下である場合は貫通クラックを適用することになっている。（大阪、高浜、美浜、玄海、川内、伊方と同様）</p> <p>・泊では、大阪と同様に原則標準支持間隔法における応力評価を実施しており、二次応力である熱応力は保守的な値として建設工認時における限度値の100MPaを一律に用いている。（大阪、高浜、美浜、玄海、川内、伊方と同様）</p> <p>【大阪】</p> <p>記載方針の相違 女川審査実績の反映 記載表現の相違</p>

赤字：設備、運用又は体制の相違（設計方針の相違）
 青字：記載箇所又は記載内容の相違（記載方針の相違）
 緑字：記載表現、設備名称の相違（実質的な相違なし）

大阪発電所3/4号炉	女川原子力発電所2号炉	泊発電所3号炉	相違理由																												
<p>b. $S_n = \frac{P_m D_o}{4t} + \frac{0.75h_1(M_s + M_b) + h_2 M_c}{Z}$</p> <p>$S_n$: 一次応力と二次応力を加えて求めた応力 (MPa) h_1, h_2 : 応力係数 M_c : 管の熱による支持点の変位及び熱膨張により生ずるモーメント (N・mm) P_m : 内面に受ける最高の圧力 (MPa) M_b : 管の機械的荷重 (透し弁又は安全弁の吹出し反力その他の短期的荷重に限る) により生ずるモーメント (N・mm) D_o : 管の外径 (mm) t : 管の厚さ (mm) M_a : 管の機械的荷重 (自重その他の長期荷重に限る) により生ずるモーメント (N・mm)</p> <p>d. $S_a = 1.25S_c + (1.2 + 0.25f)S_c$</p> <p>$S_a$: 許容応力 (MPa) f : 許容応力低減係数</p> <p>S_c : 室温における材料の許容引張応力 (MPa) S_h : 使用温度における材料の許容引張応力 (MPa)</p> <p style="text-align: center;">設計・建設規格 PPC-3530(1) 抜粋</p>	<p>(1) S_a の算出 設計・建設規格 PPC-3530(1)d. の計算式から算出する。 $S_a = 1.25fS_c + (1.2 + 0.25f) Sh \cdots \text{①式}$ S_a : 許容応力 F : 許容応力低減係数 (=1.0)</p> <p>加熱蒸気及び復水戻り系配管は、通年（運転時、定検時）において、圧力は一定に保つように設定されているため、有意な温度変化は受けず、また、補機の発停回数も有意な回数がないことから、表2より、応力低減係数を1.0に設定した。</p>	<p>(1) S_a の算出 設計・建設規格 PPC-3530(1)d. の計算式から算出する。 $S_a = 1.25fS_c + (1.2 + 0.25f) Sh \cdots \text{①式}$ S_a : 許容応力 F : 許容応力低減係数 (=1.0)</p> <p>補助蒸気系、蒸気発生器ブローダウン系（主蒸気管室外）及び主蒸気系（主蒸気管室外）配管は、通年（運転時、定期事業者検査時）において、圧力は一定に保つように設定されているため、有意な温度変化は受けず、また、補機の発停回数も有意な回数がないことから、表2より、応力低減係数を1.0に設定した。</p>	<p>【大阪】 記載方針の相違 ・女川審査実績を反映し、S_nの算出については記載しない、S_nを算出しているという点において、泊、女川と相違はない。 ・女川審査実績を反映し、S_cとS_hについての説明は後述する。 記載表現の相違</p> <p>【女川】 設計方針の相違 プラント設計による系統の相違 記載表現の相違</p>																												
	<p>表2 許容応力低減係数（設計・建設規格 PPC-3530より抜粋）</p> <table border="1" data-bbox="772 1125 1187 1284"> <thead> <tr> <th>温度変化サイクル数</th> <th>fの値</th> </tr> </thead> <tbody> <tr> <td>7,000未満</td> <td>1.0</td> </tr> <tr> <td>7,000以上14,000未満</td> <td>0.9</td> </tr> <tr> <td>14,000以上22,000未満</td> <td>0.8</td> </tr> <tr> <td>22,000以上45,000未満</td> <td>0.7</td> </tr> <tr> <td>45,000以上100,000未満</td> <td>0.6</td> </tr> <tr> <td>100,000以上</td> <td>0.5</td> </tr> </tbody> </table>	温度変化サイクル数	fの値	7,000未満	1.0	7,000以上14,000未満	0.9	14,000以上22,000未満	0.8	22,000以上45,000未満	0.7	45,000以上100,000未満	0.6	100,000以上	0.5	<p>表2 許容応力低減係数（設計・建設規格 PPC-3530より抜粋）</p> <table border="1" data-bbox="1377 1125 1758 1284"> <thead> <tr> <th>温度変化サイクル数</th> <th>fの値</th> </tr> </thead> <tbody> <tr> <td>7,000未満</td> <td>1.0</td> </tr> <tr> <td>7,000以上14,000未満</td> <td>0.9</td> </tr> <tr> <td>14,000以上22,000未満</td> <td>0.8</td> </tr> <tr> <td>22,000以上45,000未満</td> <td>0.7</td> </tr> <tr> <td>45,000以上100,000未満</td> <td>0.6</td> </tr> <tr> <td>100,000以上</td> <td>0.5</td> </tr> </tbody> </table>	温度変化サイクル数	fの値	7,000未満	1.0	7,000以上14,000未満	0.9	14,000以上22,000未満	0.8	22,000以上45,000未満	0.7	45,000以上100,000未満	0.6	100,000以上	0.5	
温度変化サイクル数	fの値																														
7,000未満	1.0																														
7,000以上14,000未満	0.9																														
14,000以上22,000未満	0.8																														
22,000以上45,000未満	0.7																														
45,000以上100,000未満	0.6																														
100,000以上	0.5																														
温度変化サイクル数	fの値																														
7,000未満	1.0																														
7,000以上14,000未満	0.9																														
14,000以上22,000未満	0.8																														
22,000以上45,000未満	0.7																														
45,000以上100,000未満	0.6																														
100,000以上	0.5																														

赤字：設備、運用又は体制の相違（設計方針の相違）
 青字：記載箇所又は記載内容の相違（記載方針の相違）
 緑字：記載表現、設備名称の相違（実質的な相違なし）

大阪発電所3/4号炉	女川原子力発電所2号炉	泊発電所3号炉	相違理由
<p>Sc：設計・建設規格付録材料図表 Part 5 に規定する材料の室温における許容引張応力（STPT38=93MPa, STPA23=103MPa, STS42=103MPa）</p> <p>Sh：設計・建設規格付録材料図表 Part 5 に規定する材料の使用温度における許容引張応力（STPT38=93MPa, STPA23=103MPa, STS42=103MPa）</p> <p>①式に上記の値を代入（STPT38の場合）し、Saを算出すると、 $Sa = 1.25 \times 1.0 \times 93 + (1.2 + 0.25 \times 1.0) \times 93$ $= 251.1 \rightarrow 251$（小数点以下を切り捨て）</p> <p>したがって、$0.4Sa = 0.4 \times 251 = 100.4 \rightarrow 100$（MPa）（小数点以下を切り捨て）となる。</p>	<p>Sc：設計・建設規格付録材料図表 Part 5 に規定する材料の室温における許容引張応力（STPG370=79MPa, STPT370=93MPa）</p> <p>Sh：設計・建設規格付録材料図表 Part 5 に規定する材料の使用温度における許容引張応力（STPG370=79MPa, STPT370=93MPa）</p> <p>①式に上記の値を代入（STPT370の場合）し、Saを算出すると、 $Sa = 1.25 \times 1.0 \times 93 + (1.2 + 0.25 \times 1.0) \times 93$ $= 116.25 + 134.85$ $= 116 + 134$（小数点以下を切り捨て）=250</p> <p>したがって、$0.8Sa = 0.8 \times 250 = 200$（MPa）、$0.4Sa = 0.4 \times 250 = 100$（MPa）となる。</p>	<p>【女川】 <u>設計方針の相違</u> プラント設計による材質の相違。</p> <p>【女川】 <u>設計方針の相違</u> ・泊では、各項の計算結果に対して小数点以下の切り捨てを実施している。各項において切り捨てを実施するほうが、許容応力が小さくなるため保守的である。（大阪と同様） ・Saが許容応力Saの0.4倍を超え0.8倍以下である場合は貫通クラックを適用することとしているため、0.8Saの算出について記載している。 <u>記載方針の相違</u> ・0.8Sa及び0.4Saの算出における小数点以下の切り捨て処理は、STPT370の計算においては発生しないため、記載しない。 ・泊でも小数点以下の数字がある場合は、切り捨てを実施している。</p>	

赤字：設備、運用又は体制の相違（設計方針の相違）
 青字：記載箇所又は記載内容の相違（記載方針の相違）
 緑字：記載表現、設備名称の相違（実質的な相違なし）

大阪発電所3/4号炉	女川原子力発電所2号炉	泊発電所3号炉	相違理由
	<p>3. 実評価の流れ</p> <p>表1に示す高エネルギー配管の想定破損除外を適用する溢水防護区画内の配管系について3次元梁モデルを構築し、解析により発生応力を算出する。以下に解析条件を示す。</p> <p>(1) 系統条件</p> <ul style="list-style-type: none"> 200A-HS-100-1, 200A-HSCR-152-2, 200A-HSCR-153 100A-HSCR-152-3, 25A-HSCR-220, 20A-HSCR-452-1 40A-HSCR-208, 25A-HSCR-159, 25A-HSCR-206, 25A-HSCR-466-1 100A-RCIC-6-2（原子炉隔離時冷却水系としては最高使用温度302℃, 8.62MPa）最高使用温度：188℃ 最高使用圧力：0.96MPa 20A-HS-562-1, 40A-HS-110, 50A-HS-4, 100A-HS-109, 250A-HS-3, 最高使用温度：204℃ 最高使用圧力：1.57MPa 	<p>3. 実評価の流れ</p> <p>表1に示す高エネルギー配管の想定破損除外又は貫通クラックを適用する溢水防護区画内の配管系について、標準支持間隔法又は3次元はりモデル解析により発生応力を算出する。以下に解析条件を示す。</p> <p>(1) 系統条件</p> <ul style="list-style-type: none"> 補助蒸気系 最高使用温度：185℃ 最高使用圧力：0.93MPa 蒸気発生器ブローダウン系 最高使用温度：291℃ 最高使用圧力：7.48MPa 主蒸気系 最高使用温度：291℃ 最高使用圧力：7.48MPa 	<p>【女川】</p> <p><u>記載表現の相違</u> <u>設計方針の相違</u></p> <ul style="list-style-type: none"> 泊は高エネルギー配管に対して、貫通クラックを適用している系統がある。（大阪、高浜、美浜、玄海、川内、伊方と同様） 泊では標準支持間隔法により発生応力が最も高くなるものを代表ブロックとして抽出し、3次元はりモデル解析を実施している。また、代表ブロック以外の系統については、標準支持間隔法による評価を実施し、許容応力を満足しない場合は、3次元はりモデル解析を実施している。（大阪、川内、玄海と同様） <p>【女川】</p> <p><u>設計方針の相違</u></p> <ul style="list-style-type: none"> プラント設計による系統の相違。 女川では、想定破損除外のために3次元はりモデル解析を実施する配管を抽出し、当該配管の溢水防護区画番号及びライン番号を記載している。 泊では、原則として標準支持間隔法を用いた応力評価を実施するため個別配管の溢水防護区画番号及びライン番号を特定する必要はないが、3次元はりモデル解析を実施する一部の配管については解析モデル図で対象配管を明確にしている。（後段の9-別添1-添13-8の大阪の図1を参照。） 系統の相違による最高使用温度、最高使用圧力の相違。

赤字：設備、運用又は体制の相違（設計方針の相違）
 青字：記載箇所又は記載内容の相違（記載方針の相違）
 緑字：記載表現、設備名称の相違（実質的な相違なし）

大阪発電所3/4号炉	女川原子力発電所2号炉	泊発電所3号炉	相違理由																				
<p style="text-align: right;">補足資料3-3（別紙1）</p> <p>6. 標準支持間隔法に用いる SPAN コード</p> <table border="1" data-bbox="123 391 678 531"> <thead> <tr> <th>対象設備</th> <th>計算機プログラム名 (解析コード名)</th> <th>計算機プログラムバージョン</th> <th>製造元</th> <th>解析対象 (使用目的)</th> </tr> </thead> <tbody> <tr> <td>配管類</td> <td>SPAN2000</td> <td>4.0</td> <td>三菱重工</td> <td>耐震最大支持間隔算出</td> </tr> </tbody> </table> <p>【美浜3号炉】 まとめ資料p.1-9-補-157より抜粋</p> <table border="1" data-bbox="138 659 658 815"> <thead> <tr> <th>対象設備</th> <th>計算機プログラム名 (解析コード名)</th> <th>計算機プログラムバージョン</th> <th>製造元</th> <th>解析対象 (使用目的)</th> </tr> </thead> <tbody> <tr> <td>配管類</td> <td>SPAN2000</td> <td>4.0 5.0 6.0</td> <td>三菱重工</td> <td>耐震最大支持間隔算出</td> </tr> </tbody> </table>	対象設備	計算機プログラム名 (解析コード名)	計算機プログラムバージョン	製造元	解析対象 (使用目的)	配管類	SPAN2000	4.0	三菱重工	耐震最大支持間隔算出	対象設備	計算機プログラム名 (解析コード名)	計算機プログラムバージョン	製造元	解析対象 (使用目的)	配管類	SPAN2000	4.0 5.0 6.0	三菱重工	耐震最大支持間隔算出	<p>(2) 地震条件 弾性設計用地震動 Sd の 1/3 を入力とし、水平及び鉛直地震動を考慮し、スペクトルモーダル解析にて応力を算出する。</p> <p>(3) 解析コード SOLVER Rev.02.05</p> <p>(4) その他 100A-RCIC-6-2 については、運転期間が短期間（プラントの通常運転時の1%より小さい）であることから、低エネルギー配管に分類した上で、評価を実施する。</p>	<p>(2) 地震条件 弾性設計用地震動 Sd の 1/3 を入力とし、水平及び鉛直地震動を考慮し、スペクトルモーダル解析にて応力を算出する。</p> <p>(3) 解析コード ・標準支持間隔法 SPAN2000 Ver. 4.0 Ver. 5.0 Ver. 6.0 ・3次元はりモデル解析 MSAP PCL0版</p>	<p>相違理由</p> <p>【女川】 <u>設計方針の相違</u> ・泊では、原則標準支持間隔法による解析を実施しており、必要に応じて3次元はりモデル解析を実施している。 ・SPANコードについては、大阪も同様にSPAN2000を用いており、美浜においては、泊と同様のVerを用いている。 ・泊でも女川と同様に3次元はりモデル解析を実施しており、「MSAP PCL0版」を用いている。本解析コードについては、先行PWRの資料には記載がなかったものの、メーカー確認の結果、先行PWRでは泊と同様のコードを使用していることを確認している。</p> <p>【大阪】 <u>記載表現の相違</u> <u>記載方針の相違</u> 女川審査実績の反映</p> <p>【女川】 <u>記載内容の相違</u> 女川は区画内のHS系について抽出した上で、HS系に含まれているRCIC配管の運転時間が短期間で低エネルギー配管であることを記載している。泊では、その他として記載する内容は無い。</p>
対象設備	計算機プログラム名 (解析コード名)	計算機プログラムバージョン	製造元	解析対象 (使用目的)																			
配管類	SPAN2000	4.0	三菱重工	耐震最大支持間隔算出																			
対象設備	計算機プログラム名 (解析コード名)	計算機プログラムバージョン	製造元	解析対象 (使用目的)																			
配管類	SPAN2000	4.0 5.0 6.0	三菱重工	耐震最大支持間隔算出																			

赤字：設備、運用又は体制の相違（設計方針の相違）
 青字：記載箇所又は記載内容の相違（記載方針の相違）
 緑字：記載表現、設備名称の相違（実質的な相違なし）

大阪発電所3/4号炉	女川原子力発電所2号炉	泊発電所3号炉	相違理由
<p>2. 破損形状の設定フロー</p>		<p>(4) 破損形状の評価フロー</p> <p>高エネルギー配管の破損形状の評価フローを図1に示す。</p>	<p>【女川】 設計方針の相違 泊は原則標準支持間隔法を用いており、必要に応じて3次元はりモデル解析を実施しているため、評価フローを記載した。(評価フローについては、大阪と同様)</p> <p>【大阪】 記載表現の相違 大阪の図の名称が評価フロー、タイトルが設定フローとなっているため、泊ではタイトルと図の名称の統一を図り、評価フローとして記載する。</p>
<p>図1 高エネルギー配管の破損形状の評価フロー</p>		<p>図1 高エネルギー配管の破損形状の評価フロー</p>	

赤字：設備、運用又は体制の相違（設計方針の相違）
 青字：記載箇所又は記載内容の相違（記載方針の相違）
 緑字：記載表現、設備名称の相違（実質的な相違なし）

大阪発電所3/4号炉	女川原子力発電所2号炉	泊発電所3号炉	相違理由
<p>3.3. 破損形状の決定</p> <p>すべての建屋、階高で配管に発生する最大応力は0.8Saを下回っていることを確認した。したがって、高エネルギー配管に想定する破損形状は貫通クラックとした。</p> <div style="border: 1px solid black; padding: 5px; margin-top: 20px;"> <p>【島根2号炉】添付資料7「耐震B,Cクラス機器・配管系の評価について」より抜粋 p9条-別添1-添付7-10</p> <p>3. 耐震B,Cクラス配管及び配管支持構造物の耐震評価結果について</p> <p>耐震B,Cクラス配管及び配管支持構造物の基準地震動Ssに対する耐震性評価結果について表3-1に示す。</p> <p>なお、本評価結果は暫定条件を用いた評価結果であることから、正式条件を用いた評価結果は詳細設計段階で示す。</p> </div>	<p>4. 高エネルギー配管（加熱蒸気系）の想定破損除外の評価結果</p> <p>評価の結果、加熱蒸気系及び復水戻り系配管の応力は、サポート追設の対応を実施することにより、$S_n \leq 0.4S_a$ となり、想定破損除外を適用できることを確認した。</p> <p>なお、評価対象となる区画内には、ターミナルエンドが設置されていないことを確認している。</p> <p>対象とした加熱蒸気系配管のモデル図を図1~3に、最大応力発生箇所における応力評価結果を表3に示す。</p>	<p>4. 高エネルギー配管（補助蒸気系、蒸気発生器ブローダウン系、主蒸気系）の応力評価結果</p> <p>評価の結果、補助蒸気系配管の応力は $0.4S_a < S_n \leq 0.8S_a$ となり、貫通クラックを適用できることを確認した。また、蒸気発生器ブローダウン系及び主蒸気系配管の応力は、サポート追設の対応を実施することにより、$S_n \leq 0.4S_a$ となり、想定破損除外を適用できることを確認した。</p> <p>なお、評価対象となる区画内には、ターミナルエンドが設置されていないことを確認している。</p> <p>対象とした補助蒸気系配管、蒸気発生器ブローダウン系配管及び主蒸気系配管のモデル図を図2,3に、最大応力発生箇所における応力評価結果を表3,4に示す。</p> <p>なお、本評価結果は暫定条件を用いた評価結果であることから、正式条件を用いた評価結果は詳細設計段階で示す。</p>	<p>【女川】 <u>設計方針の相違</u></p> <ul style="list-style-type: none"> ・プラント設計による系統の相違 ・泊は想定破損除外の適用に加えて貫通クラックを適用している配管もあるため、応力評価結果としている。（大阪、高浜、美浜、玄海、川内、伊方と同様） <p>【大阪】 <u>記載方針の相違</u></p> <ul style="list-style-type: none"> ・女川審査実績を反映し、評価結果について、一次応力+二次応力 S_n の数値を記載した上で許容応力を満足することを記載する。 <p>【女川】 <u>設計方針の相違</u></p> <ul style="list-style-type: none"> ・プラント設計による系統の相違。 ・泊は想定破損除外の適用に加えて貫通クラックを適用している配管がある。（大阪、高浜、美浜、玄海、川内、伊方と同様） <p>【女川】 <u>設計方針の相違</u> <u>記載表現の相違</u> <u>記載方針の相違</u></p> <p>応力評価結果は基本設計段階における評価結果であり、正式な評価結果は詳細設計段階で示すことを記載している。</p>

赤字：設備、運用又は体制の相違（設計方針の相違）
 青字：記載箇所又は記載内容の相違（記載方針の相違）
 緑字：記載表現、設備名称の相違（実質的な相違なし）

大阪発電所3/4号炉	女川原子力発電所2号炉	泊発電所3号炉	相違理由																																																																																																																																																					
<p>【玄海3/4号炉】 まとめ資料 p.9 条-別添1-補3-1-16 より抜粋 表-1 応力評価結果（3次元はりモデルによる評価）</p> <table border="1" data-bbox="152 338 667 418"> <thead> <tr> <th>建屋</th> <th>EL. (m)</th> <th>配管仕様</th> <th>配管名</th> <th>一次+二次応力 (MPa)</th> <th>許容値※ 0.8Sa (MPa)</th> </tr> </thead> <tbody> <tr> <td>A/B</td> <td>~19.25</td> <td>1+1/2B-sch40</td> <td>補助蒸気系統配管</td> <td>101</td> <td>170</td> </tr> </tbody> </table>	建屋	EL. (m)	配管仕様	配管名	一次+二次応力 (MPa)	許容値※ 0.8Sa (MPa)	A/B	~19.25	1+1/2B-sch40	補助蒸気系統配管	101	170	<p>表3 最大応力発生箇所における応力評価結果(1/3)</p> <table border="1" data-bbox="707 220 1263 992"> <thead> <tr> <th rowspan="2">区画</th> <th rowspan="2">解析モデル (対象ライン)</th> <th colspan="5">一次+二次応力 (MPa)</th> <th rowspan="2">許容値 0.4Sa (MPa)</th> </tr> <tr> <th>内圧応力</th> <th>自重応力</th> <th>地震応力</th> <th>二次応力</th> <th>合計</th> </tr> </thead> <tbody> <tr> <td rowspan="2">R-1F-5</td> <td>HS-002 (200A-HS-100-1)</td> <td>7</td> <td>1</td> <td>10</td> <td>48</td> <td>66^{※1}</td> <td>100</td> </tr> <tr> <td>HS-001 (50A-HS-4)</td> <td>5</td> <td>1</td> <td>16</td> <td>27</td> <td>49^{※1}</td> <td>100</td> </tr> <tr> <td>R-1F-12</td> <td>HS-001 (50A-HS-4)</td> <td>5</td> <td>1</td> <td>7</td> <td>79</td> <td>92^{※1}</td> <td>100</td> </tr> <tr> <td rowspan="4">R-B1F-1</td> <td>HS-001-1 (100A-HS-121)</td> <td>5</td> <td>4</td> <td>6</td> <td>70</td> <td>85^{※1}</td> <td>100</td> </tr> <tr> <td>HS-004 (40A-HS-110)</td> <td>3</td> <td>4</td> <td>23</td> <td>63</td> <td>93^{※1}</td> <td>100</td> </tr> <tr> <td>HSCR-003 (200A-HSCR-152-2)</td> <td>7</td> <td>2</td> <td>14</td> <td>77</td> <td>100^{※1}</td> <td>111</td> </tr> <tr> <td>HSCR-003 (25A-HSCR-220)</td> <td colspan="5">評価除外 (25A以下)</td> <td></td> <td></td> </tr> <tr> <td rowspan="7">R-B2F-1</td> <td>HS-001-1 (100A-HS-121)</td> <td>5</td> <td>3</td> <td>15</td> <td>68</td> <td>91^{※1}</td> <td>100</td> </tr> <tr> <td>HS-001-1 (100A-HS-123)</td> <td>5</td> <td>1</td> <td>18</td> <td>64</td> <td>88^{※1}</td> <td>100</td> </tr> <tr> <td>HS-001-1 (100A-HS-127)</td> <td>5</td> <td>11</td> <td>9</td> <td>59</td> <td>84^{※1}</td> <td>100</td> </tr> <tr> <td>HS-004 (40A-HS-110)</td> <td>3</td> <td>4</td> <td>14</td> <td>72</td> <td>93^{※1}</td> <td>100</td> </tr> <tr> <td>HSCR-003 (200A-HSCR-152-2)</td> <td>7</td> <td>1</td> <td>19</td> <td>78</td> <td>105^{※1}</td> <td>111</td> </tr> <tr> <td>HSCR-003 (200A-HSCR-153)</td> <td>7</td> <td>4</td> <td>17</td> <td>17</td> <td>45^{※1}</td> <td>111</td> </tr> <tr> <td>HS-004 (40A-HSCR-208)</td> <td>2</td> <td>11</td> <td>30</td> <td>52</td> <td>95^{※1}</td> <td>100</td> </tr> </tbody> </table> <p>※1 サポート追加後（対策後）の評価値であり、設計選捗により変更の可能性有り</p>	区画	解析モデル (対象ライン)	一次+二次応力 (MPa)					許容値 0.4Sa (MPa)	内圧応力	自重応力	地震応力	二次応力	合計	R-1F-5	HS-002 (200A-HS-100-1)	7	1	10	48	66 ^{※1}	100	HS-001 (50A-HS-4)	5	1	16	27	49 ^{※1}	100	R-1F-12	HS-001 (50A-HS-4)	5	1	7	79	92 ^{※1}	100	R-B1F-1	HS-001-1 (100A-HS-121)	5	4	6	70	85 ^{※1}	100	HS-004 (40A-HS-110)	3	4	23	63	93 ^{※1}	100	HSCR-003 (200A-HSCR-152-2)	7	2	14	77	100 ^{※1}	111	HSCR-003 (25A-HSCR-220)	評価除外 (25A以下)							R-B2F-1	HS-001-1 (100A-HS-121)	5	3	15	68	91 ^{※1}	100	HS-001-1 (100A-HS-123)	5	1	18	64	88 ^{※1}	100	HS-001-1 (100A-HS-127)	5	11	9	59	84 ^{※1}	100	HS-004 (40A-HS-110)	3	4	14	72	93 ^{※1}	100	HSCR-003 (200A-HSCR-152-2)	7	1	19	78	105 ^{※1}	111	HSCR-003 (200A-HSCR-153)	7	4	17	17	45 ^{※1}	111	HS-004 (40A-HSCR-208)	2	11	30	52	95 ^{※1}	100	<p>表3 最大応力発生箇所における応力評価結果（貫通クラック）</p> <table border="1" data-bbox="1290 210 1854 338"> <thead> <tr> <th rowspan="2">配管</th> <th rowspan="2">口径 (B)</th> <th colspan="5">一次+二次応力 (MPa)</th> <th rowspan="2">許容値 0.8Sa (MPa)</th> </tr> <tr> <th>内圧応力</th> <th>自重応力</th> <th>地震応力</th> <th>二次応力</th> <th>合計</th> </tr> </thead> <tbody> <tr> <td>補助蒸気系統配管</td> <td>4</td> <td>4.5</td> <td>22.1</td> <td>32.3</td> <td>100</td> <td>159</td> <td>169</td> </tr> </tbody> </table>	配管	口径 (B)	一次+二次応力 (MPa)					許容値 0.8Sa (MPa)	内圧応力	自重応力	地震応力	二次応力	合計	補助蒸気系統配管	4	4.5	22.1	32.3	100	159	169	<p>【女川】 <u>設計方針の相違</u> ・泊は想定破損除外を適用する他に、貫通クラックを適用するパターンがあり、想定破損除外と貫通クラックで許容値が異なるため、表3（貫通クラック）と表4（想定破損除外）に分けて記載している。 ・女川は、溢水防護区画内の応力評価が必要な配管ラインを特定した上で、3次元はりモデル解析を実施している。一方、泊でも3次元はりモデル解析を実施しているが、対象ライン名称及び区画の特定を実施していないことから、記載しない。（玄海と同様） ・一次+二次応力の相違はプラント系統構成による相違。許容値は材質が異なることによる相違。</p> <p>【玄海】 表の体裁は女川を参照し記載するが、参考として補助蒸気配管に対して貫通クラックを想定する評価結果を示す。</p>
建屋	EL. (m)	配管仕様	配管名	一次+二次応力 (MPa)	許容値※ 0.8Sa (MPa)																																																																																																																																																			
A/B	~19.25	1+1/2B-sch40	補助蒸気系統配管	101	170																																																																																																																																																			
区画	解析モデル (対象ライン)	一次+二次応力 (MPa)					許容値 0.4Sa (MPa)																																																																																																																																																	
		内圧応力	自重応力	地震応力	二次応力	合計																																																																																																																																																		
R-1F-5	HS-002 (200A-HS-100-1)	7	1	10	48	66 ^{※1}	100																																																																																																																																																	
	HS-001 (50A-HS-4)	5	1	16	27	49 ^{※1}	100																																																																																																																																																	
R-1F-12	HS-001 (50A-HS-4)	5	1	7	79	92 ^{※1}	100																																																																																																																																																	
R-B1F-1	HS-001-1 (100A-HS-121)	5	4	6	70	85 ^{※1}	100																																																																																																																																																	
	HS-004 (40A-HS-110)	3	4	23	63	93 ^{※1}	100																																																																																																																																																	
	HSCR-003 (200A-HSCR-152-2)	7	2	14	77	100 ^{※1}	111																																																																																																																																																	
	HSCR-003 (25A-HSCR-220)	評価除外 (25A以下)																																																																																																																																																						
R-B2F-1	HS-001-1 (100A-HS-121)	5	3	15	68	91 ^{※1}	100																																																																																																																																																	
	HS-001-1 (100A-HS-123)	5	1	18	64	88 ^{※1}	100																																																																																																																																																	
	HS-001-1 (100A-HS-127)	5	11	9	59	84 ^{※1}	100																																																																																																																																																	
	HS-004 (40A-HS-110)	3	4	14	72	93 ^{※1}	100																																																																																																																																																	
	HSCR-003 (200A-HSCR-152-2)	7	1	19	78	105 ^{※1}	111																																																																																																																																																	
	HSCR-003 (200A-HSCR-153)	7	4	17	17	45 ^{※1}	111																																																																																																																																																	
	HS-004 (40A-HSCR-208)	2	11	30	52	95 ^{※1}	100																																																																																																																																																	
配管	口径 (B)	一次+二次応力 (MPa)					許容値 0.8Sa (MPa)																																																																																																																																																	
		内圧応力	自重応力	地震応力	二次応力	合計																																																																																																																																																		
補助蒸気系統配管	4	4.5	22.1	32.3	100	159	169																																																																																																																																																	

赤字：設備、運用又は体制の相違（設計方針の相違）
 青字：記載箇所又は記載内容の相違（記載方針の相違）
 緑字：記載表現、設備名称の相違（実質的な相違なし）

大阪発電所3/4号炉	女川原子力発電所2号炉	泊発電所3号炉	相違理由																																																																																																					
	<p>表3 最大応力発生箇所における応力評価結果(2/3)</p> <table border="1"> <thead> <tr> <th rowspan="2">区画</th> <th rowspan="2">解析モデル (対象ライン)</th> <th colspan="5">一次+二次応力 (MPa)</th> <th rowspan="2">許容値 0.4Sa (MPa)</th> </tr> <tr> <th>内圧 応力</th> <th>自重 応力</th> <th>地震 応力</th> <th>二次 応力</th> <th>合計</th> </tr> </thead> <tbody> <tr> <td rowspan="2">R-B2F-1</td> <td>HS-004 (25A-HSCR-159) (25A-HSCR-206)</td> <td colspan="5" rowspan="2">評価除外 (25A 以下)</td> <td rowspan="2"></td> </tr> <tr> <td>HSCR-003 (20A-HSCR-452-1) (20A-HSCR-452-2)</td> </tr> <tr> <td>R-B2F-5</td> <td>HS-004 (40A-HSCR-208)</td> <td>3</td> <td>1</td> <td>6</td> <td>85</td> <td>95^{*1}</td> <td>100</td> </tr> <tr> <td rowspan="5">R-B3F-2</td> <td>HS-130 (20A-HS-129)</td> <td colspan="5" rowspan="5">評価除外 (25A 以下)</td> <td rowspan="5"></td> </tr> <tr> <td>HS-104 (20A-HS-733)</td> </tr> <tr> <td>HS-105 (20A-HS-734)</td> </tr> <tr> <td>HSCR-001-1 (25A-HSCR-241) (25A-HSCR-242) (25A-HSCR-243) (25A-HSCR-244) (25A-HSCR-245) (20A-HSCR-581-1) (20A-HSCR-582-1)</td> </tr> <tr> <td></td> </tr> <tr> <td rowspan="2">C-1F-1</td> <td>HS-003 (250A-HS-3)</td> <td>13</td> <td>2</td> <td>3</td> <td>77</td> <td>95^{*1}</td> <td>100</td> </tr> <tr> <td>HSCR-001 (80A-HSCR-85)</td> <td>5</td> <td>2</td> <td>3</td> <td>87</td> <td>97^{*1}</td> <td>111</td> </tr> <tr> <td rowspan="2">C-1F-3</td> <td>HS-003 (250A-HS-3)</td> <td>13</td> <td>1</td> <td>6</td> <td>68</td> <td>88^{*1}</td> <td>100</td> </tr> <tr> <td>HSCR-001 (80A-HSCR-85)</td> <td>5</td> <td>13</td> <td>7</td> <td>22</td> <td>47^{*1}</td> <td>111</td> </tr> </tbody> </table> <p><small>*1 サポート追加後(対策後)の評価値であり、設計進捗により変更の可能性有り</small></p>	区画	解析モデル (対象ライン)	一次+二次応力 (MPa)					許容値 0.4Sa (MPa)	内圧 応力	自重 応力	地震 応力	二次 応力	合計	R-B2F-1	HS-004 (25A-HSCR-159) (25A-HSCR-206)	評価除外 (25A 以下)						HSCR-003 (20A-HSCR-452-1) (20A-HSCR-452-2)	R-B2F-5	HS-004 (40A-HSCR-208)	3	1	6	85	95 ^{*1}	100	R-B3F-2	HS-130 (20A-HS-129)	評価除外 (25A 以下)						HS-104 (20A-HS-733)	HS-105 (20A-HS-734)	HSCR-001-1 (25A-HSCR-241) (25A-HSCR-242) (25A-HSCR-243) (25A-HSCR-244) (25A-HSCR-245) (20A-HSCR-581-1) (20A-HSCR-582-1)		C-1F-1	HS-003 (250A-HS-3)	13	2	3	77	95 ^{*1}	100	HSCR-001 (80A-HSCR-85)	5	2	3	87	97 ^{*1}	111	C-1F-3	HS-003 (250A-HS-3)	13	1	6	68	88 ^{*1}	100	HSCR-001 (80A-HSCR-85)	5	13	7	22	47 ^{*1}	111	<p>表4 最大応力発生箇所における応力評価結果(想定破損除外)</p> <table border="1"> <thead> <tr> <th rowspan="2">配管</th> <th rowspan="2">口径 (B)</th> <th colspan="5">一次+二次応力 (MPa)</th> <th rowspan="2">許容値 0.4Sa (MPa)</th> </tr> <tr> <th>内圧 応力</th> <th>自重 応力</th> <th>地震 応力</th> <th>二次 応力</th> <th>合計</th> </tr> </thead> <tbody> <tr> <td>蒸気発生器ブロー ダウン系配管</td> <td>3</td> <td>33.3</td> <td>0.6</td> <td>32.9</td> <td>13.3</td> <td>81</td> <td>100</td> </tr> <tr> <td>主蒸気系配管</td> <td>3</td> <td>32.9</td> <td>0.4</td> <td>57.7</td> <td>1.5</td> <td>93</td> <td>100</td> </tr> </tbody> </table>	配管	口径 (B)	一次+二次応力 (MPa)					許容値 0.4Sa (MPa)	内圧 応力	自重 応力	地震 応力	二次 応力	合計	蒸気発生器ブロー ダウン系配管	3	33.3	0.6	32.9	13.3	81	100	主蒸気系配管	3	32.9	0.4	57.7	1.5	93	100	<p>【女川】</p> <p>記載表現の相違 設計方針の相違</p> <ul style="list-style-type: none"> 一次+二次応力の相違はプラント系統構成による相違。許容値は材質が異なることによる相違 泊でも3次元はりモデル解析を実施しているが、対象ライン名称及び区画の特定を実施していないことから、記載していない。(玄海と同様)
区画	解析モデル (対象ライン)			一次+二次応力 (MPa)						許容値 0.4Sa (MPa)																																																																																														
		内圧 応力	自重 応力	地震 応力	二次 応力	合計																																																																																																		
R-B2F-1	HS-004 (25A-HSCR-159) (25A-HSCR-206)	評価除外 (25A 以下)																																																																																																						
	HSCR-003 (20A-HSCR-452-1) (20A-HSCR-452-2)																																																																																																							
R-B2F-5	HS-004 (40A-HSCR-208)	3	1	6	85	95 ^{*1}	100																																																																																																	
R-B3F-2	HS-130 (20A-HS-129)	評価除外 (25A 以下)																																																																																																						
	HS-104 (20A-HS-733)																																																																																																							
	HS-105 (20A-HS-734)																																																																																																							
	HSCR-001-1 (25A-HSCR-241) (25A-HSCR-242) (25A-HSCR-243) (25A-HSCR-244) (25A-HSCR-245) (20A-HSCR-581-1) (20A-HSCR-582-1)																																																																																																							
C-1F-1	HS-003 (250A-HS-3)	13	2	3	77	95 ^{*1}	100																																																																																																	
	HSCR-001 (80A-HSCR-85)	5	2	3	87	97 ^{*1}	111																																																																																																	
C-1F-3	HS-003 (250A-HS-3)	13	1	6	68	88 ^{*1}	100																																																																																																	
	HSCR-001 (80A-HSCR-85)	5	13	7	22	47 ^{*1}	111																																																																																																	
配管	口径 (B)	一次+二次応力 (MPa)					許容値 0.4Sa (MPa)																																																																																																	
		内圧 応力	自重 応力	地震 応力	二次 応力	合計																																																																																																		
蒸気発生器ブロー ダウン系配管	3	33.3	0.6	32.9	13.3	81	100																																																																																																	
主蒸気系配管	3	32.9	0.4	57.7	1.5	93	100																																																																																																	

赤字：設備、運用又は体制の相違（設計方針の相違）
 青字：記載箇所又は記載内容の相違（記載方針の相違）
 緑字：記載表現、設備名称の相違（実質的な相違なし）

大阪発電所3/4号炉	女川原子力発電所2号炉	泊発電所3号炉	相違理由																																	
	<p>表3 最大応力発生箇所における応力評価結果(3/3)</p> <table border="1" data-bbox="698 212 1270 453"> <thead> <tr> <th rowspan="2">区画</th> <th rowspan="2">解析モデル (対象ライン)</th> <th colspan="4">一次+二次応力 (MPa)</th> <th rowspan="2">許容値 0.4S_s (MPa)</th> </tr> <tr> <th>内圧 応力</th> <th>自重 応力</th> <th>地震 応力</th> <th>二次 応力</th> </tr> </thead> <tbody> <tr> <td rowspan="3">非管理 区域 (T/D)</td> <td>HSCR-003 (150A-HSCR-79)</td> <td>5</td> <td>4</td> <td>11</td> <td>40</td> <td>60^{*)}</td> <td>111</td> </tr> <tr> <td>HSCR-003 (80A-HSCR-54-3)</td> <td>5</td> <td>18</td> <td>32</td> <td>47</td> <td>102^{*)}</td> <td>111</td> </tr> <tr> <td>HSCR-003 (50A-HSCR-75)</td> <td>3</td> <td>4</td> <td>18</td> <td>85</td> <td>110^{*)}</td> <td>111</td> </tr> </tbody> </table> <p>※1 サポート追加後(対策後)の評価値であり、設計進捗により変更の可能性有り</p>	区画	解析モデル (対象ライン)	一次+二次応力 (MPa)				許容値 0.4S _s (MPa)	内圧 応力	自重 応力	地震 応力	二次 応力	非管理 区域 (T/D)	HSCR-003 (150A-HSCR-79)	5	4	11	40	60 ^{*)}	111	HSCR-003 (80A-HSCR-54-3)	5	18	32	47	102 ^{*)}	111	HSCR-003 (50A-HSCR-75)	3	4	18	85	110 ^{*)}	111		<p>【女川】</p> <p>記載表現の相違 設計方針の相違</p> <ul style="list-style-type: none"> 一次+二次応力の相違はプラント系統構成による相違。許容値は材質が異なることによる相違 泊でも3次元はりモデル解析を実施しているが、対象ライン名称及び区画の特定を実施していないことから、記載していない。(玄海と同様)
区画	解析モデル (対象ライン)			一次+二次応力 (MPa)					許容値 0.4S _s (MPa)																											
		内圧 応力	自重 応力	地震 応力	二次 応力																															
非管理 区域 (T/D)	HSCR-003 (150A-HSCR-79)	5	4	11	40	60 ^{*)}	111																													
	HSCR-003 (80A-HSCR-54-3)	5	18	32	47	102 ^{*)}	111																													
	HSCR-003 (50A-HSCR-75)	3	4	18	85	110 ^{*)}	111																													

赤字：設備、運用又は体制の相違（設計方針の相違）
 青字：記載箇所又は記載内容の相違（記載方針の相違）
 緑字：記載表現、設備名称の相違（実質的な相違なし）

大阪発電所3/4号炉	女川原子力発電所2号炉	泊発電所3号炉	相違理由
	<p>図1 HS-001 解析モデル図 (最小裕度の範囲)</p> <p>この図は、女川原子力発電所2号炉のHS-001解析モデルを示しています。図の中心には、複雑な管路ネットワークが描かれています。赤い線が「解析対象範囲」を示し、その範囲内には「評価対象区画 R/B (2次格納施設内)」と「対象区画内の最小裕度の評価点 No.34」が示されています。また、赤い線は「HS-001(7/2)」とラベルされています。図には、圧力、温度、流量などのパラメータを示す記号や、方向を示す矢印も含まれています。</p>	<p>図2 蒸気発生器ブローダウン系配管 解析モデル図 (最小裕度の範囲)</p> <p>この図は、泊発電所3号炉の蒸気発生器ブローダウン系配管の解析モデルを示しています。図の中心には、管路ネットワークが描かれています。赤い線が「解析対象範囲」を示し、その範囲内には「範囲内での最小裕度の評価点 No.132」が示されています。また、赤い線は「HS-001(7/2)」とラベルされています。図には、圧力、温度、流量などのパラメータを示す記号や、方向を示す矢印も含まれています。</p>	<p>【女川】 <u>設計方針の相違</u> 応力評価の対象とした系統の相違</p> <p>【女川】 <u>記載表現の相違</u></p>

赤字：設備、運用又は体制の相違（設計方針の相違）
 青字：記載箇所又は記載内容の相違（記載方針の相違）
 緑字：記載表現、設備名称の相違（実質的な相違なし）

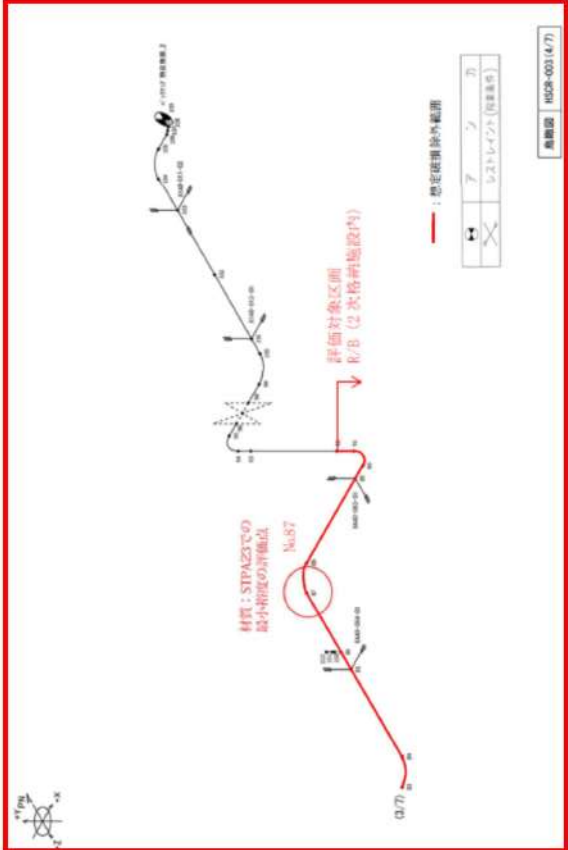
大阪発電所3/4号炉	女川原子力発電所2号炉	泊発電所3号炉	相違理由
	 <p data-bbox="705 1133 1270 1157">図3 HSCR-003 解析モデル図 (STPA23 最小裕度の範囲) (1/2)</p>		<p data-bbox="1874 183 2136 271">【女川】 設計方針の相違 応力評価の対象とした系統の相違</p> <p data-bbox="1874 1029 2136 1093">【女川】 記載表現の相違</p>

赤字：設備、運用又は体制の相違 (設計方針の相違)
 青字：記載箇所又は記載内容の相違 (記載方針の相違)
 緑字：記載表現、設備名称の相違 (実質的な相違なし)

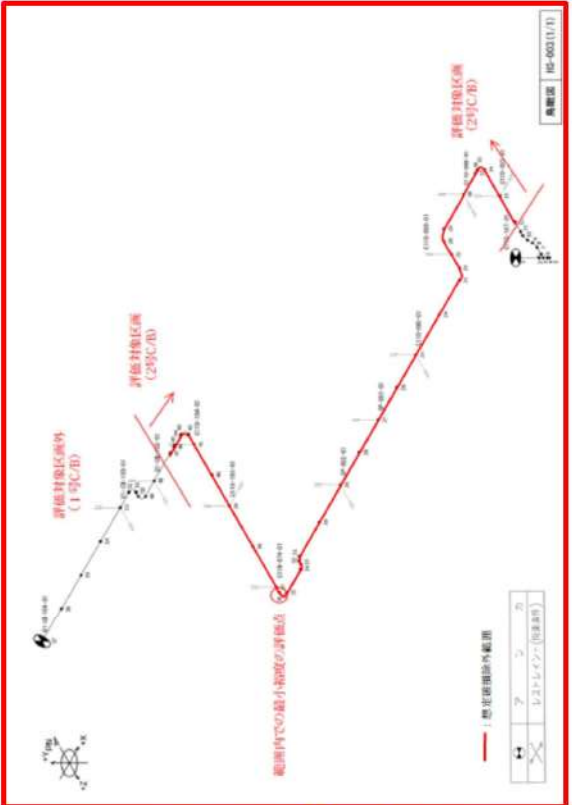
大阪発電所3/4号炉	女川原子力発電所2号炉	泊発電所3号炉	相違理由
	 <p data-bbox="712 997 1263 1021">図3 HS-003 解析モデル図 (STPT38 最小裕度の範囲) (2/2)</p>		<p data-bbox="1874 177 2136 268">【女川】 設計方針の相違 応力評価の対象とした系統の相違</p> <p data-bbox="1874 962 2136 1021">【女川】 記載表現の相違</p>

赤字：設備、運用又は体制の相違（設計方針の相違）
 青字：記載箇所又は記載内容の相違（記載方針の相違）
 緑字：記載表現、設備名称の相違（実質的な相違なし）

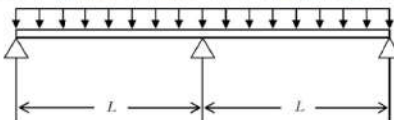
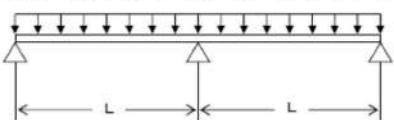
大阪発電所3/4号炉	女川原子力発電所2号炉	泊発電所3号炉	相違理由
<p style="text-align: right;">別紙3</p> <p>標準支持間隔法による一次応力評価</p> <p>1. 基本方針</p> <p>本件の想定破損の配管強度評価は、高エネルギー配管のうち補助蒸気供給配管と低エネルギー配管の一次応力に対して標準支持間隔法を用いている。標準支持間隔法では、標準支持間隔以下で配管を敷設することで、発生応力が標準支持間隔で算出した一次応力以下となる。</p> <p>標準支持間隔の算出は以下の基準及び規格に基づき実施する。</p> <ul style="list-style-type: none"> ・日本電気協会「原子力発電所耐震設計技術指針」（JEAG4601-1987） ・日本電気協会「原子力発電所耐震設計技術指針重要度分類・許容応力編」（JEAG4601・補-1984） ・日本電気協会「原子力発電所耐震設計技術指針」（JEAG4601-1991 追補版） ・日本機械学会「発電用原子力設備規格設計・建設規格」（JSME S NC1-2005/2007） <p>評価に用いる弾性設計用地震動 S_d に基づく床応答曲線は、耐震設計で用いるものと同じである。</p> <p>また、標準支持間隔の計算に用いる配管系の設計用減衰については、5. 参考文献に示す既往研究等において試験等により妥当性が確認されている値を使用する。（参考文献参照）</p> <p>2. 支持間隔算出の方法</p> <p>2.1. 概要</p> <p>標準支持間隔は、配管系の内圧、自重及び地震力に基づき、一次応力の評価基準値内になるように階高に応じて算出する。</p> <p>なお、地震応力の算出にあたっては、耐震設計で用いる各弾性設計用地震動 S_d による床応答曲線と同じものを用いる。</p> <p>2.2. 直管部の支持間隔</p> <p>2.2.1. 解析モデル</p> <p>各種配管を図5のように支持間隔 L で3点支持した等分布質量の連続梁にモデル化する。この場合、支持点の拘束方向は軸直角方向のみとし、軸方向及び回転に対しては自由とする。</p>  <p style="text-align: center;">図5 標準支持間隔法の解析モデル</p>		<p style="text-align: right;">別紙</p> <p>標準支持間隔法による一次応力評価</p> <p>1. 基本方針</p> <p>想定破損の配管強度評価は、高エネルギー配管のうち補助蒸気系統配管及び低エネルギー配管の一次応力に対して標準支持間隔法を用いている。標準支持間隔法では、標準支持間隔以下で配管を敷設することで、発生応力が標準支持間隔で算出した一次応力以下となる。</p> <p>標準支持間隔の算出は以下の基準及び規格に基づき実施する。</p> <ul style="list-style-type: none"> ・日本電気協会「原子力発電所耐震設計技術指針」（JEAG4601-1987） ・日本電気協会「原子力発電所耐震設計技術指針重要度分類・許容応力編」（JEAG4601・補-1984） ・日本電気協会「原子力発電所耐震設計技術指針」（JEAG4601-1991 追補版） ・日本機械学会「発電用原子力設備規格設計・建設規格」（JSME S NC1-2005/2007） <p>評価に用いる弾性設計用地震動に基づく床応答曲線は、耐震設計で用いるものと同じである。</p> <p>また、標準支持間隔の計算に用いる配管系の設計用減衰については、5. 参考文献に示す既往研究等において試験等により妥当性が確認されている値を使用する。（参考文献参照）</p> <p>2. 支持間隔算出の方法</p> <p>2.1 概要</p> <p>標準支持間隔は、配管系の内圧、自重及び地震力に基づき、一次応力の評価基準値内になるように階高に応じて算出する。</p> <p>なお、地震応力の算出に当たっては、耐震設計で用いる各弾性設計用地震動による床応答曲線と同じものを用いる。</p> <p>2.2 支持間隔</p> <p>2.2.1 解析モデル</p> <p>各種配管を図1のように支持間隔 L で3点支持した等分布質量の連続梁にモデル化する。この場合、支持点の拘束方向は軸直角方向のみとし、軸方向及び回転に対しては自由とする。</p>  <p style="text-align: center;">図1 標準支持間隔法の解析モデル</p>	<p>【女川】 設計方針の相違 泊では、想定破損における一次応力を算出するために標準支持間隔法を用いている。一方、女川では溢水影響評価に必要な配管について、3次元はりモデル解析を実施しているため、別紙の内容については、大阪の資料との比較を実施する。</p> <p>【大阪】 記載表現の相違</p> <p>【大阪】 記載表現の相違</p>

赤字：設備、運用又は体制の相違（設計方針の相違）
 青字：記載箇所又は記載内容の相違（記載方針の相違）
 緑字：記載表現、設備名称の相違（実質的な相違なし）

大阪発電所3/4号炉	女川原子力発電所2号炉	泊発電所3号炉	相違理由																																				
<p>2.2.2. 解析条件及び解析方法</p> <p>①各種配管について、内圧及び自重の影響と地震力（(1/3) Sd）による応力を算出して最大支持間隔を求める。</p> <p>②配管の自重は、配管自体の重量と内部流体の重量とを合計した値とする。さらに、保温材ありの配管についてはその重量を考慮する。また、高エネルギー配管は別途二次応力として熱応力（100MPa）を考慮する。</p> <p>3. 地震力</p> <p>解析に使用する地震力（(1/3) Sd）は表2のとおりである。なお、減衰の設定において、保温材の効果は考慮している。</p> <p style="text-align: center;">表2 地震力の種類例</p> <table border="1" data-bbox="118 560 678 715"> <thead> <tr> <th>建屋</th> <th>床応答曲線高さ E.L. +(m)</th> <th>減衰 (%)</th> </tr> </thead> <tbody> <tr> <td>原子炉</td> <td>低:17.1、26.0、33.6、47.3</td> <td>0.5、2.0</td> </tr> <tr> <td>周辺建屋</td> <td>高:33.6~17.1、33.6</td> <td>0.5、1.5、3.0</td> </tr> <tr> <td rowspan="2">制御建屋</td> <td>低:11.5、15.8、21.3、26.1、33.6</td> <td>0.5、2.0</td> </tr> <tr> <td>高:33.6~15.8、33.6</td> <td>0.5、1.5、3.0</td> </tr> </tbody> </table> <p>低:低エネルギー配管、高:高エネルギー（補助蒸気）配管</p>	建屋	床応答曲線高さ E.L. +(m)	減衰 (%)	原子炉	低:17.1、26.0、33.6、47.3	0.5、2.0	周辺建屋	高:33.6~17.1、33.6	0.5、1.5、3.0	制御建屋	低:11.5、15.8、21.3、26.1、33.6	0.5、2.0	高:33.6~15.8、33.6	0.5、1.5、3.0		<p>2. 2. 2 解析条件及び解析方法</p> <p>①各種配管について、内圧及び自重の影響と地震力（(1/3) Sd）による応力を算出して最大支持間隔を求める。</p> <p>②配管の自重は、配管自体の重量と内部流体の重量とを合計した値とする。さらに、保温材ありの配管についてはその重量を考慮する。また、高エネルギー配管は別途二次応力として熱応力（100MPa）を考慮する。</p> <p>3. 地震力</p> <p>解析に使用する地震力（(1/3) Sd）は表1のとおりである。なお、減衰の設定において、保温材の効果は考慮している。</p> <p style="text-align: center;">表1 地震力の種類例</p> <table border="1" data-bbox="1290 560 1850 858"> <thead> <tr> <th>建屋</th> <th>床応答曲線高さ T.P. (m)</th> <th>減衰 (%)</th> </tr> </thead> <tbody> <tr> <td rowspan="2">周辺補機棟 (RE/B)</td> <td>低:17.8、24.8、33.1</td> <td>0.5、2.0</td> </tr> <tr> <td>高:17.8、24.8、33.1</td> <td>1.5</td> </tr> <tr> <td>燃料取扱棟 (PI/B)</td> <td>低:41.0、47.6、55.0</td> <td>0.5、2.0</td> </tr> <tr> <td rowspan="2">原子炉補助建屋 (A/B)</td> <td>低:10.3、17.8、24.8、33.1、38.1、40.3、42.2、43.3、47.6</td> <td>0.5、2.0</td> </tr> <tr> <td>高:10.3、17.8、24.8、33.1</td> <td>1.5</td> </tr> <tr> <td>ディーゼル発電機建屋 (DG/B)</td> <td>低:10.3、18.8</td> <td>0.5、2.0</td> </tr> <tr> <td>循環水ポンプ建屋 (CWF/B)</td> <td>低:10.05</td> <td>0.5、2.0</td> </tr> </tbody> </table> <p>低:低エネルギー配管、高:高エネルギー（補助蒸気）配管</p>	建屋	床応答曲線高さ T.P. (m)	減衰 (%)	周辺補機棟 (RE/B)	低:17.8、24.8、33.1	0.5、2.0	高:17.8、24.8、33.1	1.5	燃料取扱棟 (PI/B)	低:41.0、47.6、55.0	0.5、2.0	原子炉補助建屋 (A/B)	低:10.3、17.8、24.8、33.1、38.1、40.3、42.2、43.3、47.6	0.5、2.0	高:10.3、17.8、24.8、33.1	1.5	ディーゼル発電機建屋 (DG/B)	低:10.3、18.8	0.5、2.0	循環水ポンプ建屋 (CWF/B)	低:10.05	0.5、2.0	<p>【大阪】 記載表現の相違</p> <p>【大阪】 記載方針の相違 プラント設計による建屋名称、床応答曲線高さ、減衰の相違。</p>
建屋	床応答曲線高さ E.L. +(m)	減衰 (%)																																					
原子炉	低:17.1、26.0、33.6、47.3	0.5、2.0																																					
周辺建屋	高:33.6~17.1、33.6	0.5、1.5、3.0																																					
制御建屋	低:11.5、15.8、21.3、26.1、33.6	0.5、2.0																																					
	高:33.6~15.8、33.6	0.5、1.5、3.0																																					
建屋	床応答曲線高さ T.P. (m)	減衰 (%)																																					
周辺補機棟 (RE/B)	低:17.8、24.8、33.1	0.5、2.0																																					
	高:17.8、24.8、33.1	1.5																																					
燃料取扱棟 (PI/B)	低:41.0、47.6、55.0	0.5、2.0																																					
原子炉補助建屋 (A/B)	低:10.3、17.8、24.8、33.1、38.1、40.3、42.2、43.3、47.6	0.5、2.0																																					
	高:10.3、17.8、24.8、33.1	1.5																																					
ディーゼル発電機建屋 (DG/B)	低:10.3、18.8	0.5、2.0																																					
循環水ポンプ建屋 (CWF/B)	低:10.05	0.5、2.0																																					
<p>4. 評価手順</p> <p>一次応力のうち標準支持間隔法を用いた具体的な評価手順を以下の図6に示す。</p>		<p>4. 評価手順</p> <p>一次応力のうち標準支持間隔法を用いた具体的な評価手順を以下の図2に示す。</p>	<p>【大阪】 記載表現の相違</p>																																				

赤字：設備、運用又は体制の相違（設計方針の相違）
 青字：記載箇所又は記載内容の相違（記載方針の相違）
 緑字：記載表現、設備名称の相違（実質的な相違なし）

第9条 溢水による損傷の防止等（別添1 添付資料13）

大阪発電所3/4号炉

設計用応答曲線

入力地震動	(1/3)Sd [®]
減衰	IEAG等の値
床応答曲線階高	耐震設計と同じ
床応答曲線容れめ	有
床応答曲線ピーク保持	有
NS・EP包絡	有

※スペクトル波と階層波を包絡

INPUT

標準支持間隔算出プログラム
解析コード「SPAN」

応力制限 0.8Sa, 0.4Sa
(溢水ガイド 附属書A)

OUTPUT

階高	EL. Cm	EL. Cm	EL. Cm
仕様	○B Sch○	○, Cm (CMPa)	○, Cm (CMPa)
...			

比較

施工図

図6 標準支持間隔法を用いた具体的な評価手順

5. 参考文献

原子力規制委員会ホームページ「電源開発株式会社大間原子力発電所第1号機の工事計画認可申請に係る意見聴取会（機器・配管系）（第2回）意見反映版 資料4 機器・配管系の設計用減衰定数について」
<http://www.nsr.go.jp/archive/nisa/shingikai/800/6/002/4.pdf>

女川原子力発電所2号炉

設計用応答曲線

入力地震動	(L/3) Sd
減衰	IEAG等の値
床応答曲線階高	耐震設計と同じ
床応答曲線容れめ	有
床応答曲線ピーク保持	有
NS・EP包絡	有

※スペクトル波と階層波を包絡

INPUT

標準支持間隔算出プログラム
解析コード「SPAN」

応力制限 0.8Sa, 0.4Sa
(溢水ガイド 附属書A)

OUTPUT

階高	T.P. Cm	T.P. Cm	T.P. Cm
仕様	○, Cm (CMPa)	○, Cm (CMPa)	○, Cm (CMPa)
...			

比較

施工図

図2 標準支持間隔法を用いた具体的な評価手順

5. 参考文献

「電源開発株式会社大間原子力発電所第1号機の工事計画認可申請に係る意見聴取会（機器・配管系）（第2回）意見反映版資料4 機器・配管系の設計用減衰定数について（改2）」

泊発電所3号炉

設計用応答曲線

入力地震動	(L/3) Sd
減衰	IEAG等の値
床応答曲線階高	耐震設計と同じ
床応答曲線容れめ	有
床応答曲線ピーク保持	有
NS・EP包絡	有

※スペクトル波と階層波を包絡

INPUT

標準支持間隔算出プログラム
解析コード「SPAN」

応力制限 0.8Sa, 0.4Sa
(溢水ガイド 附属書A)

OUTPUT

階高	T.P. Cm	T.P. Cm	T.P. Cm
仕様	○, Cm (CMPa)	○, Cm (CMPa)	○, Cm (CMPa)
...			

比較

施工図

図2 標準支持間隔法を用いた具体的な評価手順

5. 参考文献

「電源開発株式会社大間原子力発電所第1号機の工事計画認可申請に係る意見聴取会（機器・配管系）（第2回）意見反映版資料4 機器・配管系の設計用減衰定数について（改2）」

相違理由

【大阪】
 記載表現の相違

【大阪】
 記載方針の相違

赤字：設備、運用又は体制の相違（設計方針の相違）
 青字：記載箇所又は記載内容の相違（記載方針の相違）
 緑字：記載表現、設備名称の相違（実質的な相違なし）

大阪発電所3/4号炉	女川原子力発電所2号炉	泊発電所3号炉	相違理由
<p style="text-align: right;">補足資料 3-3（別紙2）</p> <p>低エネルギー配管の破損形状の設定</p> <p>1. 概要</p> <p>配管破損を想定する系統の低エネルギー配管について、溢水ガイド附属書Aの低エネルギー配管の評価対象（25A以上）に対し、許容応力の0.4倍を超える場合は貫通クラックを想定する旨の記載にしたがって評価している。</p> <p>本資料は低エネルギー配管の応力評価とその結果についてとりまとめたものである。</p>	<p style="text-align: right;">添付資料 15</p> <p>低エネルギー配管の想定破損除外について</p> <p>1. 評価対象配管</p> <p>想定破損除外の適用（応力評価）を実施する対象配管を表1に示す。</p>	<p style="text-align: right;">添付資料 14</p> <p>低エネルギー配管の想定破損除外について</p> <p>1. 評価対象配管</p> <p>想定破損除外の適用（応力評価）を実施する対象配管を表1に示す。</p>	<p>【女川・大飯】</p> <p>記載表現の相違</p> <p>【大飯】</p> <p>記載方針の相違</p> <p>女川審査実績を反映し、応力評価を実施する配管を抽出した上で応力評価結果を記載する方針とする。</p>

赤字：設備、運用又は体制の相違（設計方針の相違）
 青字：記載箇所又は記載内容の相違（記載方針の相違）
 緑字：記載表現、設備名称の相違（実質的な相違なし）

第9条 溢水による損傷の防止等（別添1添付資料14）

大阪発電所3/4号炉	女川原子力発電所2号炉	泊発電所3号炉	相違理由																																																																																																																																																																																																																														
<p>補足資料3-2</p> <p>表1 低エネルギー配管を有する系統の抽出結果</p>	<p>表1 低エネルギー配管の想定破損除外を適用する対象配管</p>	<p>表1 低エネルギー配管の想定破損除外を適用する対象配管</p> <p>(1/2)</p>	<p>【女川】</p> <p>記載表現の相違</p> <p>設計方針の相違</p>																																																																																																																																																																																																																														
<table border="1"> <thead> <tr> <th>系統</th> <th>対象範囲における使用条件</th> <th>運転時間割合^{※2}</th> </tr> </thead> <tbody> <tr> <td>原子炉補機冷却系</td> <td>運転圧力：約 0.88～0.94MPa 運転温度：約 14～32℃</td> <td>—</td> </tr> <tr> <td>格納容器スプレイ系^{※1}</td> <td>運転圧力：約 2.0MPa 運転温度：約 22～29℃</td> <td><1%</td> </tr> <tr> <td>化学体積制御系</td> <td>運転圧力：約 0.14MPa 運転温度：約 28～39℃</td> <td>—</td> </tr> <tr> <td>冷水系</td> <td>運転圧力：約 0.85MPa 運転温度：約 5℃</td> <td>—</td> </tr> <tr> <td>1次系洗浄水系</td> <td>運転圧力：約 1.0MPa 運転温度：約 27℃</td> <td>—</td> </tr> <tr> <td>1次系放射性ドレン系（機器ドレン）</td> <td>運転圧力：大気圧 運転温度：約 27℃</td> <td>—</td> </tr> <tr> <td>1次系放射性ドレン系（床ドレン）</td> <td>運転圧力：大気圧 運転温度：約 27℃</td> <td>—</td> </tr> <tr> <td>消火水系</td> <td>運転圧力：約 1.0MPa 運転温度：約 27℃</td> <td>—</td> </tr> <tr> <td>1次系補給水系</td> <td>運転圧力：約 1.1MPa 運転温度：約 27℃</td> <td>—</td> </tr> <tr> <td>余熱除去系^{※1}</td> <td>運転圧力：約 2.9MPa以下 運転温度：約 177℃以下</td> <td><1%</td> </tr> <tr> <td>燃料取替用水系</td> <td>運転圧力：約 0.8MPa 運転温度：約 19～36℃</td> <td>—</td> </tr> <tr> <td>燃料ビット冷却浄化系</td> <td>運転圧力：約 0.8MPa 運転温度：約 19～36℃</td> <td>—</td> </tr> <tr> <td>安全注入系^{※1}</td> <td>運転圧力：約 15.2MPa 運転温度：約 22～29℃</td> <td><1%</td> </tr> <tr> <td>海水系</td> <td>運転圧力：約 0.45MPa 運転温度：約 10～30℃</td> <td>—</td> </tr> <tr> <td>液体廃棄物処理系</td> <td>運転圧力：約 19～47kPa 運転温度：約 105～111℃</td> <td>—</td> </tr> <tr> <td>固体廃棄物処理系</td> <td>運転圧力：大気圧 運転温度：約 27℃</td> <td>—</td> </tr> <tr> <td>補助給水系^{※1}</td> <td>運転圧力：約 10.7～12.1MPa 運転温度：約 21～29℃</td> <td><1%</td> </tr> </tbody> </table>	系統	対象範囲における使用条件	運転時間割合 ^{※2}	原子炉補機冷却系	運転圧力：約 0.88～0.94MPa 運転温度：約 14～32℃	—	格納容器スプレイ系 ^{※1}	運転圧力：約 2.0MPa 運転温度：約 22～29℃	<1%	化学体積制御系	運転圧力：約 0.14MPa 運転温度：約 28～39℃	—	冷水系	運転圧力：約 0.85MPa 運転温度：約 5℃	—	1次系洗浄水系	運転圧力：約 1.0MPa 運転温度：約 27℃	—	1次系放射性ドレン系（機器ドレン）	運転圧力：大気圧 運転温度：約 27℃	—	1次系放射性ドレン系（床ドレン）	運転圧力：大気圧 運転温度：約 27℃	—	消火水系	運転圧力：約 1.0MPa 運転温度：約 27℃	—	1次系補給水系	運転圧力：約 1.1MPa 運転温度：約 27℃	—	余熱除去系 ^{※1}	運転圧力：約 2.9MPa以下 運転温度：約 177℃以下	<1%	燃料取替用水系	運転圧力：約 0.8MPa 運転温度：約 19～36℃	—	燃料ビット冷却浄化系	運転圧力：約 0.8MPa 運転温度：約 19～36℃	—	安全注入系 ^{※1}	運転圧力：約 15.2MPa 運転温度：約 22～29℃	<1%	海水系	運転圧力：約 0.45MPa 運転温度：約 10～30℃	—	液体廃棄物処理系	運転圧力：約 19～47kPa 運転温度：約 105～111℃	—	固体廃棄物処理系	運転圧力：大気圧 運転温度：約 27℃	—	補助給水系 ^{※1}	運転圧力：約 10.7～12.1MPa 運転温度：約 21～29℃	<1%	<table border="1"> <thead> <tr> <th rowspan="2">設置エリア</th> <th rowspan="2">区画番号</th> <th rowspan="2">対象系統</th> <th colspan="2">対象配管</th> <th rowspan="2">材質</th> </tr> <tr> <th>ライン番号</th> <th></th> </tr> </thead> <tbody> <tr> <td rowspan="12">原子炉建屋 原子炉棟</td> <td>R-2F-1-1</td> <td>HNCW</td> <td>50A-HNCW-41</td> <td></td> <td>STPG38</td> </tr> <tr> <td rowspan="3">R-B3F-3</td> <td rowspan="3">RHR (A)</td> <td>350A-RHR-2-1</td> <td></td> <td rowspan="3">STS42</td> </tr> <tr> <td>100A-RHR-24-1</td> <td></td> </tr> <tr> <td>100A-RHR-33</td> <td></td> </tr> <tr> <td rowspan="3">R-B3F-6</td> <td rowspan="3">RHR (B)</td> <td>350A-RHR-4-1</td> <td></td> <td rowspan="3">STS42</td> </tr> <tr> <td>100A-RHR-25-1</td> <td></td> </tr> <tr> <td>100A-RHR-41</td> <td></td> </tr> <tr> <td rowspan="3">R-B3F-7</td> <td rowspan="3">RHR (C)</td> <td>350A-RHR-6-2</td> <td></td> <td rowspan="3">STS42</td> </tr> <tr> <td>100A-RHR-26-1</td> <td></td> </tr> <tr> <td>100A-RHR-52</td> <td></td> </tr> <tr> <td rowspan="2">R-B3F-4</td> <td rowspan="2">LPCS</td> <td>300A-LPCS-2-1</td> <td></td> <td rowspan="2">STS42</td> </tr> <tr> <td>50A-LPCS-7</td> <td></td> </tr> <tr> <td rowspan="2">R-B3F-5</td> <td rowspan="2">HPCS</td> <td>300A-HPCS-2-1</td> <td></td> <td rowspan="2">STS42</td> </tr> <tr> <td>100A-HPCS-6-1</td> <td></td> </tr> <tr> <td rowspan="2">R-B3F-2</td> <td rowspan="2">RCIC</td> <td>100A-RCIC-3-1</td> <td></td> <td rowspan="2">STS42</td> </tr> <tr> <td>50A-RCIC-5</td> <td></td> </tr> </tbody> </table>	設置エリア	区画番号	対象系統	対象配管		材質	ライン番号		原子炉建屋 原子炉棟	R-2F-1-1	HNCW	50A-HNCW-41		STPG38	R-B3F-3	RHR (A)	350A-RHR-2-1		STS42	100A-RHR-24-1		100A-RHR-33		R-B3F-6	RHR (B)	350A-RHR-4-1		STS42	100A-RHR-25-1		100A-RHR-41		R-B3F-7	RHR (C)	350A-RHR-6-2		STS42	100A-RHR-26-1		100A-RHR-52		R-B3F-4	LPCS	300A-LPCS-2-1		STS42	50A-LPCS-7		R-B3F-5	HPCS	300A-HPCS-2-1		STS42	100A-HPCS-6-1		R-B3F-2	RCIC	100A-RCIC-3-1		STS42	50A-RCIC-5		<table border="1"> <thead> <tr> <th rowspan="2">対象配管</th> <th colspan="4">設置エリア</th> <th rowspan="2">材質</th> </tr> <tr> <th>原子炉建屋</th> <th>原子炉補助建屋</th> <th>循環水ポンプ建屋</th> <th>ディーゼル発電機建屋</th> </tr> </thead> <tbody> <tr> <td>1次冷却系配管</td> <td>○</td> <td>—</td> <td>—</td> <td>—</td> <td>SUS304TP</td> </tr> <tr> <td>化学体積制御系（充てん）配管</td> <td>○</td> <td>○</td> <td>—</td> <td>—</td> <td>SUS304TP</td> </tr> <tr> <td>化学体積制御系（抽出）配管</td> <td>○</td> <td>○</td> <td>—</td> <td>—</td> <td>SUS304TP</td> </tr> <tr> <td>化学体積制御系（その他）配管</td> <td>○</td> <td>○</td> <td>—</td> <td>—</td> <td>SUS304TP</td> </tr> <tr> <td>安全注入系配管</td> <td>○</td> <td>○</td> <td>—</td> <td>—</td> <td>SUS304TP</td> </tr> <tr> <td>余熱除去系配管</td> <td>○</td> <td>○</td> <td>—</td> <td>—</td> <td>SUS304TP</td> </tr> <tr> <td>原子炉格納容器スプレイ系配管</td> <td>○</td> <td>○</td> <td>—</td> <td>—</td> <td>SUS316TP SUS316TP</td> </tr> <tr> <td>原子炉補機冷却水系配管</td> <td>○</td> <td>○</td> <td>—</td> <td>—</td> <td>STPG370 SM400A STPT370</td> </tr> <tr> <td>使用済燃料ビット水浄化冷却系配管</td> <td>○</td> <td>○</td> <td>—</td> <td>—</td> <td>SUS304TP</td> </tr> <tr> <td>原子炉補機冷却海水系配管</td> <td>○</td> <td>○</td> <td>○</td> <td>○</td> <td>STPG370 STPY400 SUS304TP SUS304TP</td> </tr> <tr> <td>液体廃棄物処理系配管</td> <td>○</td> <td>○</td> <td>—</td> <td>—</td> <td>SUS304TP SUS316LTB SUS316LTB SUS316TP</td> </tr> <tr> <td>固体廃棄物処理系配管</td> <td>—</td> <td>○</td> <td>—</td> <td>—</td> <td>SUS304TP</td> </tr> <tr> <td>試料採取系配管</td> <td>○</td> <td>○</td> <td>—</td> <td>—</td> <td>SUS304TP SUS316TB SUS316TB</td> </tr> <tr> <td>燃料取替用水系配管</td> <td>○</td> <td>—</td> <td>—</td> <td>—</td> <td>SUS304TP</td> </tr> <tr> <td>原子炉補給水系配管（脱塩水）</td> <td>○</td> <td>○</td> <td>—</td> <td>—</td> <td>SUS304TP SUS316TB</td> </tr> <tr> <td>原子炉補給水系配管（補水）</td> <td>○</td> <td>○</td> <td>—</td> <td>—</td> <td>SUS304TP</td> </tr> </tbody> </table>	対象配管	設置エリア				材質	原子炉建屋	原子炉補助建屋	循環水ポンプ建屋	ディーゼル発電機建屋	1次冷却系配管	○	—	—	—	SUS304TP	化学体積制御系（充てん）配管	○	○	—	—	SUS304TP	化学体積制御系（抽出）配管	○	○	—	—	SUS304TP	化学体積制御系（その他）配管	○	○	—	—	SUS304TP	安全注入系配管	○	○	—	—	SUS304TP	余熱除去系配管	○	○	—	—	SUS304TP	原子炉格納容器スプレイ系配管	○	○	—	—	SUS316TP SUS316TP	原子炉補機冷却水系配管	○	○	—	—	STPG370 SM400A STPT370	使用済燃料ビット水浄化冷却系配管	○	○	—	—	SUS304TP	原子炉補機冷却海水系配管	○	○	○	○	STPG370 STPY400 SUS304TP SUS304TP	液体廃棄物処理系配管	○	○	—	—	SUS304TP SUS316LTB SUS316LTB SUS316TP	固体廃棄物処理系配管	—	○	—	—	SUS304TP	試料採取系配管	○	○	—	—	SUS304TP SUS316TB SUS316TB	燃料取替用水系配管	○	—	—	—	SUS304TP	原子炉補給水系配管（脱塩水）	○	○	—	—	SUS304TP SUS316TB	原子炉補給水系配管（補水）	○	○	—	—	SUS304TP	<p>・女川では、想定破損除外のために3次元ではモデル解析を実施する配管を抽出し、当該配管の溢水防護区画番号及びライン番号を記載している。</p> <p>・泊では、原則として標準支持間隔法を用いた応力評価を実施するため個別配管の溢水防護区画番号及びライン番号を特定する必要はない。（大阪と同様）</p> <p>・設置エリア名称、材質については、プラント設計による相違。</p> <p>・泊では低エネルギー配管に対しては、大阪と同様に原則として標準支持間隔法を用いて建屋内の対象系統が想定破損除外できることを確認しており、対象系統によっては、複数の建屋に配管が設置されているため、系統と建屋を星取表の形で記載する。</p> <p>【大阪】</p> <p>記載方針の相違</p> <p>女川の審査実績を反映し、想定破損除外を適用する系統、設置エリア、材質を表で読み取れるように記載する。</p>
系統	対象範囲における使用条件	運転時間割合 ^{※2}																																																																																																																																																																																																																															
原子炉補機冷却系	運転圧力：約 0.88～0.94MPa 運転温度：約 14～32℃	—																																																																																																																																																																																																																															
格納容器スプレイ系 ^{※1}	運転圧力：約 2.0MPa 運転温度：約 22～29℃	<1%																																																																																																																																																																																																																															
化学体積制御系	運転圧力：約 0.14MPa 運転温度：約 28～39℃	—																																																																																																																																																																																																																															
冷水系	運転圧力：約 0.85MPa 運転温度：約 5℃	—																																																																																																																																																																																																																															
1次系洗浄水系	運転圧力：約 1.0MPa 運転温度：約 27℃	—																																																																																																																																																																																																																															
1次系放射性ドレン系（機器ドレン）	運転圧力：大気圧 運転温度：約 27℃	—																																																																																																																																																																																																																															
1次系放射性ドレン系（床ドレン）	運転圧力：大気圧 運転温度：約 27℃	—																																																																																																																																																																																																																															
消火水系	運転圧力：約 1.0MPa 運転温度：約 27℃	—																																																																																																																																																																																																																															
1次系補給水系	運転圧力：約 1.1MPa 運転温度：約 27℃	—																																																																																																																																																																																																																															
余熱除去系 ^{※1}	運転圧力：約 2.9MPa以下 運転温度：約 177℃以下	<1%																																																																																																																																																																																																																															
燃料取替用水系	運転圧力：約 0.8MPa 運転温度：約 19～36℃	—																																																																																																																																																																																																																															
燃料ビット冷却浄化系	運転圧力：約 0.8MPa 運転温度：約 19～36℃	—																																																																																																																																																																																																																															
安全注入系 ^{※1}	運転圧力：約 15.2MPa 運転温度：約 22～29℃	<1%																																																																																																																																																																																																																															
海水系	運転圧力：約 0.45MPa 運転温度：約 10～30℃	—																																																																																																																																																																																																																															
液体廃棄物処理系	運転圧力：約 19～47kPa 運転温度：約 105～111℃	—																																																																																																																																																																																																																															
固体廃棄物処理系	運転圧力：大気圧 運転温度：約 27℃	—																																																																																																																																																																																																																															
補助給水系 ^{※1}	運転圧力：約 10.7～12.1MPa 運転温度：約 21～29℃	<1%																																																																																																																																																																																																																															
設置エリア	区画番号	対象系統	対象配管		材質																																																																																																																																																																																																																												
			ライン番号																																																																																																																																																																																																																														
原子炉建屋 原子炉棟	R-2F-1-1	HNCW	50A-HNCW-41		STPG38																																																																																																																																																																																																																												
	R-B3F-3	RHR (A)	350A-RHR-2-1		STS42																																																																																																																																																																																																																												
			100A-RHR-24-1																																																																																																																																																																																																																														
			100A-RHR-33																																																																																																																																																																																																																														
	R-B3F-6	RHR (B)	350A-RHR-4-1		STS42																																																																																																																																																																																																																												
			100A-RHR-25-1																																																																																																																																																																																																																														
			100A-RHR-41																																																																																																																																																																																																																														
	R-B3F-7	RHR (C)	350A-RHR-6-2		STS42																																																																																																																																																																																																																												
			100A-RHR-26-1																																																																																																																																																																																																																														
			100A-RHR-52																																																																																																																																																																																																																														
	R-B3F-4	LPCS	300A-LPCS-2-1		STS42																																																																																																																																																																																																																												
			50A-LPCS-7																																																																																																																																																																																																																														
R-B3F-5	HPCS	300A-HPCS-2-1		STS42																																																																																																																																																																																																																													
		100A-HPCS-6-1																																																																																																																																																																																																																															
R-B3F-2	RCIC	100A-RCIC-3-1		STS42																																																																																																																																																																																																																													
		50A-RCIC-5																																																																																																																																																																																																																															
対象配管	設置エリア				材質																																																																																																																																																																																																																												
	原子炉建屋	原子炉補助建屋	循環水ポンプ建屋	ディーゼル発電機建屋																																																																																																																																																																																																																													
1次冷却系配管	○	—	—	—	SUS304TP																																																																																																																																																																																																																												
化学体積制御系（充てん）配管	○	○	—	—	SUS304TP																																																																																																																																																																																																																												
化学体積制御系（抽出）配管	○	○	—	—	SUS304TP																																																																																																																																																																																																																												
化学体積制御系（その他）配管	○	○	—	—	SUS304TP																																																																																																																																																																																																																												
安全注入系配管	○	○	—	—	SUS304TP																																																																																																																																																																																																																												
余熱除去系配管	○	○	—	—	SUS304TP																																																																																																																																																																																																																												
原子炉格納容器スプレイ系配管	○	○	—	—	SUS316TP SUS316TP																																																																																																																																																																																																																												
原子炉補機冷却水系配管	○	○	—	—	STPG370 SM400A STPT370																																																																																																																																																																																																																												
使用済燃料ビット水浄化冷却系配管	○	○	—	—	SUS304TP																																																																																																																																																																																																																												
原子炉補機冷却海水系配管	○	○	○	○	STPG370 STPY400 SUS304TP SUS304TP																																																																																																																																																																																																																												
液体廃棄物処理系配管	○	○	—	—	SUS304TP SUS316LTB SUS316LTB SUS316TP																																																																																																																																																																																																																												
固体廃棄物処理系配管	—	○	—	—	SUS304TP																																																																																																																																																																																																																												
試料採取系配管	○	○	—	—	SUS304TP SUS316TB SUS316TB																																																																																																																																																																																																																												
燃料取替用水系配管	○	—	—	—	SUS304TP																																																																																																																																																																																																																												
原子炉補給水系配管（脱塩水）	○	○	—	—	SUS304TP SUS316TB																																																																																																																																																																																																																												
原子炉補給水系配管（補水）	○	○	—	—	SUS304TP																																																																																																																																																																																																																												
<p>※1 通常運転時に高エネルギー状態にある運転期間が短時間であるため低エネルギー配管とした系統</p> <p>※2 運転時間割合のうち、通常運転時の運転時間については、毎月のサーベイランスの運転時間実績で評価した。格納容器スプレイ系、安全注入系及び補助給水系は事故時に動作する系統であり、定検時の調整運転等を考慮しても通常運転時に比べ十分短く、また、余熱除去ポンプの定検期間の運転時間も十分短いため、サーベイランスで代表しても評価に影響しない。</p>																																																																																																																																																																																																																																	

赤字：設備、運用又は体制の相違（設計方針の相違）
 青字：記載箇所又は記載内容の相違（記載方針の相違）
 緑字：記載表現、設備名称の相違（実質的な相違なし）

大阪発電所3/4号炉	女川原子力発電所2号炉	泊発電所3号炉	相違理由																																																																						
		<p>表1 低エネルギー配管の想定破損除外を適用する対象配管 (2/2)</p> <table border="1" data-bbox="1285 252 1856 635"> <thead> <tr> <th rowspan="2">対象配管</th> <th colspan="4">設置エリア</th> <th rowspan="2">材質</th> </tr> <tr> <th>原子炉建屋</th> <th>原子炉補助建屋</th> <th>循環水ポンプ建屋</th> <th>ディーゼル発電機建屋</th> </tr> </thead> <tbody> <tr> <td>補助蒸気系配管</td> <td>○</td> <td>○</td> <td>—</td> <td>—</td> <td>STPI370 STPG370</td> </tr> <tr> <td>水消火系配管</td> <td>○</td> <td>○</td> <td>—</td> <td>○</td> <td>STPI370 STPG370</td> </tr> <tr> <td>地下水排水系配管</td> <td>—</td> <td>○</td> <td>—</td> <td>—</td> <td>STPG370</td> </tr> <tr> <td>飲料水系配管</td> <td>○</td> <td>○</td> <td>—</td> <td>—</td> <td>STPG370</td> </tr> <tr> <td>空調用冷水系配管</td> <td>○</td> <td>○</td> <td>—</td> <td>—</td> <td>STPG370 STPI370</td> </tr> <tr> <td>補助給水系配管</td> <td>○</td> <td>—</td> <td>—</td> <td>—</td> <td>SUS304TP</td> </tr> <tr> <td>所内用水系配管</td> <td>—</td> <td>—</td> <td>○</td> <td>—</td> <td>SUS304TP</td> </tr> <tr> <td>海水電解装置海水供給・注入系配管</td> <td>—</td> <td>—</td> <td>○</td> <td>—</td> <td>SUS304TP STPG370</td> </tr> <tr> <td>海水ストレーナ排水系配管</td> <td>—</td> <td>—</td> <td>○</td> <td>—</td> <td>STPG370</td> </tr> <tr> <td>海水淡水化設備配管</td> <td>—</td> <td>—</td> <td>○</td> <td>—</td> <td>SGP</td> </tr> </tbody> </table>	対象配管	設置エリア				材質	原子炉建屋	原子炉補助建屋	循環水ポンプ建屋	ディーゼル発電機建屋	補助蒸気系配管	○	○	—	—	STPI370 STPG370	水消火系配管	○	○	—	○	STPI370 STPG370	地下水排水系配管	—	○	—	—	STPG370	飲料水系配管	○	○	—	—	STPG370	空調用冷水系配管	○	○	—	—	STPG370 STPI370	補助給水系配管	○	—	—	—	SUS304TP	所内用水系配管	—	—	○	—	SUS304TP	海水電解装置海水供給・注入系配管	—	—	○	—	SUS304TP STPG370	海水ストレーナ排水系配管	—	—	○	—	STPG370	海水淡水化設備配管	—	—	○	—	SGP	<p>【女川】 記載表現の相違 設計方針の相違</p> <ul style="list-style-type: none"> ・女川では、想定破損除外のために3次元はモデル解析を実施する配管を抽出し、当該配管の溢水防護区画番号及びライン番号を記載している。 ・泊では、原則として標準支持間隔法を用いた応力評価を実施するため個別配管の溢水防護区画番号及びライン番号を特定する必要はない。（大阪と同様） ・設置エリア名称、材質については、プラント設計による相違。 ・泊では低エネルギー配管に対しては、大阪と同様に原則として標準支持間隔法を用いて建屋内の対象系統が想定破損除外できることを確認しており、対象系統によっては、複数の建屋に配管が設置されているため、系統と建屋を星取表の形で記載する。
対象配管	設置エリア				材質																																																																				
	原子炉建屋	原子炉補助建屋	循環水ポンプ建屋	ディーゼル発電機建屋																																																																					
補助蒸気系配管	○	○	—	—	STPI370 STPG370																																																																				
水消火系配管	○	○	—	○	STPI370 STPG370																																																																				
地下水排水系配管	—	○	—	—	STPG370																																																																				
飲料水系配管	○	○	—	—	STPG370																																																																				
空調用冷水系配管	○	○	—	—	STPG370 STPI370																																																																				
補助給水系配管	○	—	—	—	SUS304TP																																																																				
所内用水系配管	—	—	○	—	SUS304TP																																																																				
海水電解装置海水供給・注入系配管	—	—	○	—	SUS304TP STPG370																																																																				
海水ストレーナ排水系配管	—	—	○	—	STPG370																																																																				
海水淡水化設備配管	—	—	○	—	SGP																																																																				

赤字：設備、運用又は体制の相違（設計方針の相違）
 青字：記載箇所又は記載内容の相違（記載方針の相違）
 緑字：記載表現、設備名称の相違（実質的な相違なし）

大阪発電所3/4号炉	女川原子力発電所2号炉	泊発電所3号炉	相違理由
<p>3.1. 評価方法</p> <p>溢水ガイド附属書Aにしたがい、供用状態A、B及び(1/3)Sd地震荷重に対して設計・建設規格 PPC-3530(1)b. の計算式により S_n（一次応力+二次応力）を算出し、設計・建設規格 PPC-3530(1)d. の計算式により求めた S_a（許容応力）との比較により破損形状を設定する。</p> <p>支持間隔に対する一次応力の算出、一次応力に対する支持間隔の算出については、標準支持間隔のモデルによるものとし（詳細は、「別紙3 標準支持間隔法による一次応力評価」を参照）、必要に応じて3次元はりモデル解析を行う。</p> <div style="border: 1px solid black; padding: 5px;"> $b. S_n = \frac{P_m D_o}{4t} + \frac{0.75 t_1 (M_c + M_b) + t_2 M_a}{Z}$ <p>S_n : 一次応力と二次応力を加えて求めた応力 (MPa) t_1, t_2 : 応力係数 M_c : 管の熱による支持点の変位及び熱膨張により生ずるモーメント (N・mm) P_m : 内面に受ける最高の圧力 (MPa) M_b : 管の機械的荷重(逃し弁又は安全弁の吹出し反力その他の短期的荷重に限る)により生ずるモーメント (N・mm) D_o : 管の外径 (mm) t : 管の厚さ (mm) M_a : 管の機械的荷重(自重その他の長期荷重に限る)により生ずるモーメント (N・mm)</p> </div> <div style="border: 1px solid black; padding: 5px;"> $d. S_a = 1.25 f_s + (1.2 + 0.25 f) S_c$ <p>S_a : 許容応力 (MPa) f : 許容応力低減係数</p> <p>S_c : 室温における材料の許容引張応力 (MPa) S_h : 使用温度における材料の許容引張応力 (MPa)</p> <p style="text-align: right;">設計・建設規格 PPC-3530(1) 抜粋</p> </div>	<p>2. 評価方法</p> <p>表1に記載している配管はクラス2又は非安全系の配管であることから、溢水ガイド附属書Aのクラス2、3又は非安全系の配管に適用される計算式により応力評価を実施し、評価条件を満足することを確認する。</p> <p>供用状態A、B及び(1/3)Sd地震荷重に対して設計・建設規格 PPC-3530(1)b. の計算式により計算した（一次応力+二次応力）S_nが、設計・建設規格 PPC-3530(1)d. の計算式により求めた許容応力 S_a の0.4倍以下であることを確認する。</p> <p>(1) S_aの算出 設計・建設規格 PPC-3530(1)d. の計算式から算出する。 $S_a = 1.25 f S_c + (1.2 + 0.25 f) S_h \dots$ ①式 S_a : 許容応力 f : 許容応力低減係数 (=1.0) (設計・建設規格 2005 解説より)</p> <p>7000回は約20年間毎日温度変化サイクルがあることを意味しており、通常の系では7000回以下と考えられる。 本系統においては毎日において有意な温度変化は受けないため、表2より、応力低減係数を1.0とした。</p>	<p>2. 評価方法</p> <p>表1に記載している配管はクラス2、3又は非安全系の配管であることから、溢水ガイド附属書Aのクラス2、3又は非安全系の配管に適用される計算式により応力評価を実施し、評価条件を満足することを確認する。</p> <p>供用状態A、B及び(1/3)Sd地震荷重に対して設計・建設規格 PPC-3530(1)b. の計算式により計算した（一次応力+二次応力）S_nが、設計・建設規格 PPC-3530(1)d. の計算式により求めた許容応力 S_a の0.4倍以下であることを確認する。</p> <p>支持間隔に対する一次応力の算出、一次応力に対する支持間隔の算出については、標準支持間隔のモデルによるものとし（詳細は、「添付資料13 高エネルギー配管の想定破損除外又は貫通クラックについて」の「別紙 標準支持間隔法による一次応力評価」を参照）、必要に応じて3次元はりモデル解析を行う。</p> <p>(1) S_aの算出 設計・建設規格 PPC-3530(1)d. の計算式から算出する。 $S_a = 1.25 f S_c + (1.2 + 0.25 f) S_h \dots$ ①式 S_a : 許容応力 f : 許容応力低減係数 (=1.0) (設計・建設規格 2005 解説より)</p> <p>7,000回は約20年間毎日温度変化サイクルがあることを意味しており、通常の系では7,000回以下と考えられる。 本系統においては毎日において有意な温度変化は受けないため、表2より、応力低減係数を1.0とした。</p>	<p>【大阪】 記載表現の相違</p> <p>【女川】 設計方針の相違 泊は想定破損除外の対象となる低エネルギー配管にクラス3配管が含まれていることによる相違。 (大阪と同様)</p> <p>【大阪】 記載表現の相違</p> <p>【女川】 設計方針の相違 泊では、大阪と同様に原則標準支持間隔法を用いて応力評価を実施している。</p> <p>【大阪】 記載方針の相違 ・女川審査実績を反映し、S_nの算出については記載しない。S_nを算出しているという点において、泊、女川と相違はない。 ・女川審査実績を反映し、S_cとS_hについての説明は後述する。 記載表現の相違</p> <p>【女川】 記載表現の相違</p>

赤字：設備、運用又は体制の相違（設計方針の相違）
 青字：記載箇所又は記載内容の相違（記載方針の相違）
 緑字：記載表現、設備名称の相違（実質的な相違なし）

大阪発電所3/4号炉	女川原子力発電所2号炉	泊発電所3号炉	相違理由																												
	<p>表2 許容応力低減係数（設計・建設規格 PPC-3530 より抜粋）</p> <table border="1" data-bbox="779 209 1189 368"> <thead> <tr> <th>温度変化サイクル数</th> <th>fの値</th> </tr> </thead> <tbody> <tr> <td>7,000未満</td> <td>1.0</td> </tr> <tr> <td>7,000以上14,000未満</td> <td>0.9</td> </tr> <tr> <td>14,000以上22,000未満</td> <td>0.8</td> </tr> <tr> <td>22,000以上45,000未満</td> <td>0.7</td> </tr> <tr> <td>45,000以上100,000未満</td> <td>0.6</td> </tr> <tr> <td>100,000以上</td> <td>0.5</td> </tr> </tbody> </table> <p>Sc：設計・建設規格付録材料図表 Part5 に規定する材料の室温における許容引張応力（STPG38=93MPa, STS42=103MPa） Sh：設計・建設規格付録材料図表 Part5 に規定する材料の使用温度における許容引張応力（STPG38=93MPa, STS42=103MPa）</p> <p>①式に上記の値（STPG38 の場合）を代入し、Sa を算出すると、 $Sa = 1.25 \times 1.0 \times 93 + (1.2 + 0.25 \times 1.0) \times 93$ $= 251.1 \rightarrow 251$（小数点以下を切り捨て）</p> <p>したがって、$0.4Sa = 0.4 \times 251 = 100.4 \rightarrow 100$ (MPa)（小数点以下を切り捨て）となる。</p>	温度変化サイクル数	fの値	7,000未満	1.0	7,000以上14,000未満	0.9	14,000以上22,000未満	0.8	22,000以上45,000未満	0.7	45,000以上100,000未満	0.6	100,000以上	0.5	<p>表2 許容応力低減係数（設計・建設規格 PPC-3530 より抜粋）</p> <table border="1" data-bbox="1384 209 1749 368"> <thead> <tr> <th>温度変化サイクル数</th> <th>fの値</th> </tr> </thead> <tbody> <tr> <td>7,000未満</td> <td>1.0</td> </tr> <tr> <td>7,000以上14,000未満</td> <td>0.9</td> </tr> <tr> <td>14,000以上22,000未満</td> <td>0.8</td> </tr> <tr> <td>22,000以上45,000未満</td> <td>0.7</td> </tr> <tr> <td>45,000以上100,000未満</td> <td>0.6</td> </tr> <tr> <td>100,000以上</td> <td>0.5</td> </tr> </tbody> </table> <p>Sc：設計・建設規格付録材料図表 Part5 に規定する材料の室温における許容引張応力（STPG370=79MPa, SUS304TP=103MPa） Sh：設計・建設規格付録材料図表 Part5 に規定する材料の使用温度における許容引張応力（STPG370=79MPa, SUS304TP=97MPa）</p> <p>①式に上記の値（STPG370 の場合）を代入し、Sa を算出すると、 $Sa = 1.25 \times 1.0 \times 79 + (1.2 + 0.25 \times 1.0) \times 79$ $= 98.75 + 114.55$ $= 98 + 114$（小数点以下を切り捨て）= 212</p> <p>したがって、$0.4Sa = 0.4 \times 212 = 84.8 \rightarrow 84$ (MPa)（小数点以下を切り捨て）となる。</p>	温度変化サイクル数	fの値	7,000未満	1.0	7,000以上14,000未満	0.9	14,000以上22,000未満	0.8	22,000以上45,000未満	0.7	45,000以上100,000未満	0.6	100,000以上	0.5	<p>【女川】 設計方針の相違</p> <ul style="list-style-type: none"> ・プラント設計による材質の相違。 ・泊では、各項の計算結果に対して小数点以下の切り捨てを実施している。各項において切り捨てを実施するほうが、許容応力が小さくなるため保守的である。（大阪と同様）
温度変化サイクル数	fの値																														
7,000未満	1.0																														
7,000以上14,000未満	0.9																														
14,000以上22,000未満	0.8																														
22,000以上45,000未満	0.7																														
45,000以上100,000未満	0.6																														
100,000以上	0.5																														
温度変化サイクル数	fの値																														
7,000未満	1.0																														
7,000以上14,000未満	0.9																														
14,000以上22,000未満	0.8																														
22,000以上45,000未満	0.7																														
45,000以上100,000未満	0.6																														
100,000以上	0.5																														

赤字：設備、運用又は体制の相違（設計方針の相違）
 青字：記載箇所又は記載内容の相違（記載方針の相違）
 緑字：記載表現、設備名称の相違（実質的な相違なし）

大阪発電所3/4号炉	女川原子力発電所2号炉	泊発電所3号炉	相違理由																								
	<p>3. 実評価の流れ</p> <p>表1に示す低エネルギー配管の想定破損除外を適用する溢水防護区画内の配管系について3次元梁モデルを構築し、解析により発生応力を算出する。</p> <p>表3に解析条件を示す。</p> <p>(1) 系統条件</p> <p style="text-align: center;">表3 解析条件</p> <table border="1" data-bbox="703 699 1265 855"> <thead> <tr> <th>対象系統</th> <th>最高使用温度 (°C)</th> <th>最高使用圧力 (MPa)</th> </tr> </thead> <tbody> <tr> <td>HNCW</td> <td>66</td> <td>1.28</td> </tr> <tr> <td>RHR</td> <td>186^{※1}</td> <td>3.73</td> </tr> <tr> <td>LPCS</td> <td>100</td> <td>4.42</td> </tr> <tr> <td>HPCS</td> <td>100</td> <td>10.79</td> </tr> <tr> <td>RCIC</td> <td>66</td> <td>11.78</td> </tr> </tbody> </table> <p>※1 RHR(A),(B)系については、S/C吸込弁が「閉」となっている運転モードを除いた場合のRHR(A),(B)系の最高使用温度となる100°Cで評価を実施した。</p> <p>(2) 地震条件</p> <p>弾性設計用地震動Sdの1/3を入力とし、水平及び鉛直地震動を考慮し、スペクトルモーダル解析にて応力を算出する。</p>	対象系統	最高使用温度 (°C)	最高使用圧力 (MPa)	HNCW	66	1.28	RHR	186 ^{※1}	3.73	LPCS	100	4.42	HPCS	100	10.79	RCIC	66	11.78	<p>3. 実評価の流れ</p> <p>表1に示す低エネルギー配管の想定破損除外を適用する溢水防護区画内の配管系について、標準支持間隔法又は3次元はりモデル解析により発生応力を算出する。</p> <p>表3に解析条件を示す。</p> <p>(1) 系統条件</p> <p style="text-align: center;">表3 解析条件</p> <table border="1" data-bbox="1285 740 1848 839"> <thead> <tr> <th>対象系統</th> <th>最高使用温度 (°C)</th> <th>最高使用圧力 (MPa)</th> </tr> </thead> <tbody> <tr> <td>低エネルギー配管 全系統</td> <td>95^{※1}</td> <td>1.9^{※1}</td> </tr> </tbody> </table> <p>※1 低エネルギー配管の上限値</p> <p>(2) 地震条件</p> <p>弾性設計用地震動Sdの1/3を入力とし、水平及び鉛直地震動を考慮し、スペクトルモーダル解析にて応力を算出する。</p>	対象系統	最高使用温度 (°C)	最高使用圧力 (MPa)	低エネルギー配管 全系統	95 ^{※1}	1.9 ^{※1}	<p>【女川】</p> <p>設計方針の相違</p> <p>泊では標準支持間隔法により発生応力が最も高くなるものを代表ブロックとして抽出し、代表ブロックに対して、3次元はりモデル解析による確認を実施している。また、代表ブロック以外の系統については、標準支持間隔法により評価を実施し、許容応力を満足しない場合は、3次元はりモデル解析による確認を実施する評価フローとなっている。(大飯と同様)</p> <p>【女川】</p> <p>設計方針の相違</p> <p>泊では、全ての低エネルギー配管に対して、低エネルギー配管の上限値である温度及び圧力を設定して解析を行っている。(大飯と同様)</p>
対象系統	最高使用温度 (°C)	最高使用圧力 (MPa)																									
HNCW	66	1.28																									
RHR	186 ^{※1}	3.73																									
LPCS	100	4.42																									
HPCS	100	10.79																									
RCIC	66	11.78																									
対象系統	最高使用温度 (°C)	最高使用圧力 (MPa)																									
低エネルギー配管 全系統	95 ^{※1}	1.9 ^{※1}																									

赤字：設備、運用又は体制の相違（設計方針の相違）
 青字：記載箇所又は記載内容の相違（記載方針の相違）
 緑字：記載表現、設備名称の相違（実質的な相違なし）

大阪発電所3/4号炉	女川原子力発電所2号炉	泊発電所3号炉	相違理由																				
<p style="text-align: right;">補足資料3-3（別紙1）</p> <p>6. 標準支持間隔法に用いる SPAN コード</p> <table border="1" data-bbox="123 255 676 395"> <thead> <tr> <th>対象設備</th> <th>計算機 プログラム名 (解析コード名)</th> <th>計算機 プログラム バージョン</th> <th>製造元</th> <th>解析対象 (使用目的)</th> </tr> </thead> <tbody> <tr> <td>配管類</td> <td>SPAN2000</td> <td>4.0</td> <td>三菱重工</td> <td>耐震最大 支持間隔算出</td> </tr> </tbody> </table> <p>【美浜3号炉】 まとめ資料p.1-9-補-157より抜粋</p> <table border="1" data-bbox="138 523 660 679"> <thead> <tr> <th>対象設備</th> <th>計算機 プログラム名 (解析コード名)</th> <th>計算機 プログラム バージョン</th> <th>製造元</th> <th>解析対象 (使用目的)</th> </tr> </thead> <tbody> <tr> <td>配管類</td> <td>SPAN2000</td> <td>4.0 5.0 6.0</td> <td>三菱重工</td> <td>耐震最大 支持間隔算出</td> </tr> </tbody> </table>	対象設備	計算機 プログラム名 (解析コード名)	計算機 プログラム バージョン	製造元	解析対象 (使用目的)	配管類	SPAN2000	4.0	三菱重工	耐震最大 支持間隔算出	対象設備	計算機 プログラム名 (解析コード名)	計算機 プログラム バージョン	製造元	解析対象 (使用目的)	配管類	SPAN2000	4.0 5.0 6.0	三菱重工	耐震最大 支持間隔算出	<p>(3) 解析コード</p> <p>SOLVER Rev.02.05 ISAP-III</p>	<p>(3) 解析コード</p> <ul style="list-style-type: none"> ・標準支持間隔法 SPAN2000 Ver. 4.0 Ver. 5.0 Ver. 6.0 ・3次元はりモデル解析 MSAP PC1.0版 	<p>【女川】</p> <p><u>設計方針の相違</u></p> <ul style="list-style-type: none"> ・泊では、原則標準支持間隔法による解析を実施しており、必要に応じて3次元はりモデル解析を実施している。(大阪と同様) ・SPANコードについては、大阪も同様にSPAN2000を用いており、美浜においては、泊と同様のVerを用いている。 ・泊でも女川と同様に3次元はりモデル解析を実施しており、「MSAP PC1.0版」を用いている。本解析コードについては、先行の資料には記載がなかったものの、メーカー確認の結果、先行PWRでは泊と同様のコードを使用していることを確認している。 <p>【大阪】</p> <p><u>記載表現の相違</u> <u>記載方針の相違</u> 女川審査実績の反映</p>
対象設備	計算機 プログラム名 (解析コード名)	計算機 プログラム バージョン	製造元	解析対象 (使用目的)																			
配管類	SPAN2000	4.0	三菱重工	耐震最大 支持間隔算出																			
対象設備	計算機 プログラム名 (解析コード名)	計算機 プログラム バージョン	製造元	解析対象 (使用目的)																			
配管類	SPAN2000	4.0 5.0 6.0	三菱重工	耐震最大 支持間隔算出																			

赤字：設備、運用又は体制の相違（設計方針の相違）
 青字：記載箇所又は記載内容の相違（記載方針の相違）
 緑字：記載表現、設備名称の相違（実質的な相違なし）

大阪発電所3/4号炉	女川原子力発電所2号炉	泊発電所3号炉	相違理由
<p>2. 破損形状の設定フロー</p> <p>低エネルギー配管の破損形状の評価フローは、別紙1図1「高エネルギー配管の破損形状の評価フロー」と同じである。</p> <p>【大阪3号炉】 まとめ資料 p.2-9-別1補-174より抜粋</p> <p>図1 高エネルギー配管の破損形状の評価フロー</p>	<p>女川原子力発電所2号炉</p>	<p>(4) 破損形状の評価フロー</p> <p>低エネルギー配管の破損形状の評価フローを図1に示す。</p> <p>図1 低エネルギー配管の破損形状の評価フロー</p>	<p>【女川】 設計方針の相違 泊は原則標準支持間隔法を用いており、必要に応じて3次元はりモデル解析を実施しているため、評価フローを記載した。（大阪と同様）</p> <p>【大阪】 記載表現の相違 記載方針の相違 大阪では、低エネルギー配管の破損形状の評価フローについて、高エネルギー配管と同様としているが、実際には低エネルギー配管においては、許容応力0.4Saを満足することを確認しているため、記載を適正化している。</p>

赤字：設備、運用又は体制の相違（設計方針の相違）
 青字：記載箇所又は記載内容の相違（記載方針の相違）
 緑字：記載表現、設備名称の相違（実質的な相違なし）

大阪発電所3/4号炉	女川原子力発電所2号炉	泊発電所3号炉	相違理由
<p>3.3. 破損形状の決定</p> <p>すべての建屋、階高で配管に発生する最大応力は0.4Saを下回っていることを確認した。したがって低エネルギー配管に破損を想定する必要はないことを確認した。</p> <div style="border: 1px solid black; padding: 5px; margin-top: 10px;"> <p>【島根2号炉】添付資料7「耐震B,Cクラス機器・配管系の評価について」より抜粋 p9条-別添1-添付7-10</p> <p>3. 耐震 B,C クラス配管及び配管支持構造物の耐震評価結果について</p> <p>耐震 B,C クラス配管及び配管支持構造物の基準地震動 S_s に対する耐震性評価結果について表3-1に示す。</p> <p>なお、本評価結果は暫定条件を用いた評価結果であることから、正式条件を用いた評価結果は詳細設計段階で示す。</p> </div>	<p>4. 低エネルギー配管の想定破損除外の評価結果</p> <p>対象とした配管のモデル図を図1~12に、区画内における最小裕度となる箇所における応力評価結果を表4に示す。</p> <p>評価の結果、配管の応力は、$S_n \leq 0.4S_a$であり、想定破損除外を適用できることを確認した。</p>	<p>4. 低エネルギー配管の想定破損除外の評価結果</p> <p>対象とした配管のモデル図を図2に、区画内における最小裕度となる箇所における応力評価結果を表4に、低エネルギー配管を有する系統の応力評価結果を表5に示す。</p> <p>評価の結果、配管の応力は、$S_n \leq 0.4S_a$であり、想定破損除外を適用できることを確認した。</p> <p>なお、本評価結果は暫定条件を用いた評価結果であることから、正式条件を用いた評価結果は詳細設計段階で示す。</p>	<p>【大阪】</p> <p>記載方針の相違</p> <p>女川審査実績を反映し、評価結果について、一次応力+二次応力S_nの数値を記載した上で許容応力を満足することを記載する。</p> <p>【女川】</p> <p>設計方針の相違</p> <p>代表配管ブロックについて評価を実施した上で、それ以外の評価対象配管については、標準支持間隔法により評価を満足することを確認している。その旨を説明するために表5を作成している。</p> <p>【女川】</p> <p>記載方針の相違</p> <p>応力評価結果は基本設計段階における評価結果であり、正式な評価結果は詳細設計段階で示すことを記載している。</p>

赤字：設備、運用又は体制の相違（設計方針の相違）
 青字：記載箇所又は記載内容の相違（記載方針の相違）
 緑字：記載表現、設備名称の相違（実質的な相違なし）

大阪発電所3/4号炉	女川原子力発電所2号炉	泊発電所3号炉	相違理由																																																																																																																																									
<p>【玄海3/4号炉】 まとめ資料p.9条-別添1-補3-1-18より抜粋 表-3 応力評価結果（3次元はりモデルによる評価）</p> <table border="1" data-bbox="152 327 667 391"> <thead> <tr> <th>建屋</th> <th>EL. (m)</th> <th>配管仕様</th> <th>配管名</th> <th>一次+二次応力 (MPa)</th> <th>許容値余 0.4Sa (MPa)</th> </tr> </thead> <tbody> <tr> <td>A/B</td> <td>~19.25</td> <td>2B-sch40</td> <td>水消火系統配管</td> <td>80</td> <td>85</td> </tr> </tbody> </table>	建屋	EL. (m)	配管仕様	配管名	一次+二次応力 (MPa)	許容値余 0.4Sa (MPa)	A/B	~19.25	2B-sch40	水消火系統配管	80	85	<p>表4 最小裕度となる箇所における応力評価結果(1/2)</p> <table border="1" data-bbox="705 247 1265 933"> <thead> <tr> <th rowspan="2">区画番号</th> <th rowspan="2">解析モデル (対象ライン)</th> <th colspan="5">一次+二次応力 (MPa)</th> <th rowspan="2">許容値 0.4Sa (MPa)</th> </tr> <tr> <th>内圧 応力</th> <th>自重 応力</th> <th>地震 応力</th> <th>二次 応力</th> <th>合計</th> </tr> </thead> <tbody> <tr> <td>R-2F-1-1</td> <td>HNCW-41 (50A-HNCW-41)</td> <td>4</td> <td>1</td> <td>74</td> <td>1</td> <td>80</td> <td>100</td> </tr> <tr> <td rowspan="3">R-B3F-3</td> <td>KRR-007 (350A-KRR-2-1) (100A-KRR-24-1) (100A-KRR-33)</td> <td>30</td> <td>12</td> <td>11</td> <td>28</td> <td>81</td> <td>102</td> </tr> <tr> <td>KRR-116 (100A-KRR-24-1)</td> <td>18</td> <td>4</td> <td>19</td> <td>32</td> <td>73</td> <td>102</td> </tr> <tr> <td>R-B3F-6</td> <td>KRR-012 (350A-KRR-4-1) (100A-KRR-25-1) (100A-KRR-41)</td> <td>30</td> <td>11</td> <td>9</td> <td>27</td> <td>77</td> <td>102</td> </tr> <tr> <td></td> <td>KRR-146^{※1} (100A-KRR-25-1)</td> <td>18</td> <td>2</td> <td>27</td> <td>38</td> <td>85</td> <td>102</td> </tr> <tr> <td rowspan="3">R-B3F-7</td> <td>KRR-017 (350A-KRR-6-1) (300A-KRR-6-2) (100A-KRR-52) (100A-KRR-26-1)</td> <td>30</td> <td>11</td> <td>6</td> <td>7</td> <td>54</td> <td>102</td> </tr> <tr> <td>KRR-146^{※1} (100A-KRR-26-1)</td> <td>18</td> <td>2</td> <td>27</td> <td>38</td> <td>85</td> <td>102</td> </tr> <tr> <td>R-B3F-4</td> <td>LPCS-003 (300A-LPCS-2-1) (50A-LPCS-7) (100A-LPCS-4-1)</td> <td>21</td> <td>10</td> <td>9</td> <td>11</td> <td>51</td> <td>102</td> </tr> <tr> <td></td> <td>KLPCS-117 (100A-LPCS-4-1)</td> <td>15</td> <td>1</td> <td>16</td> <td>7</td> <td>39</td> <td>102</td> </tr> </tbody> </table>	区画番号	解析モデル (対象ライン)	一次+二次応力 (MPa)					許容値 0.4Sa (MPa)	内圧 応力	自重 応力	地震 応力	二次 応力	合計	R-2F-1-1	HNCW-41 (50A-HNCW-41)	4	1	74	1	80	100	R-B3F-3	KRR-007 (350A-KRR-2-1) (100A-KRR-24-1) (100A-KRR-33)	30	12	11	28	81	102	KRR-116 (100A-KRR-24-1)	18	4	19	32	73	102	R-B3F-6	KRR-012 (350A-KRR-4-1) (100A-KRR-25-1) (100A-KRR-41)	30	11	9	27	77	102		KRR-146 ^{※1} (100A-KRR-25-1)	18	2	27	38	85	102	R-B3F-7	KRR-017 (350A-KRR-6-1) (300A-KRR-6-2) (100A-KRR-52) (100A-KRR-26-1)	30	11	6	7	54	102	KRR-146 ^{※1} (100A-KRR-26-1)	18	2	27	38	85	102	R-B3F-4	LPCS-003 (300A-LPCS-2-1) (50A-LPCS-7) (100A-LPCS-4-1)	21	10	9	11	51	102		KLPCS-117 (100A-LPCS-4-1)	15	1	16	7	39	102	<p>表4 最小裕度となる箇所における応力評価結果</p> <table border="1" data-bbox="1288 247 1848 367"> <thead> <tr> <th rowspan="2">配管</th> <th rowspan="2">口径 (B)</th> <th colspan="5">一次+二次応力 (MPa)</th> <th rowspan="2">許容値 0.4Sa (MPa)</th> </tr> <tr> <th>内圧 応力</th> <th>自重 応力</th> <th>地震 応力</th> <th>二次 応力</th> <th>合計</th> </tr> </thead> <tbody> <tr> <td>水消火系統配管</td> <td>4</td> <td>8.6</td> <td>7.9</td> <td>5.9</td> <td>0.0</td> <td>23</td> <td>84</td> </tr> </tbody> </table> <p>表5 低エネルギー配管を有する系統の応力評価結果</p> <table border="1" data-bbox="1288 486 1848 638"> <thead> <tr> <th>配管名</th> <th>評価方法</th> <th>建屋</th> <th>T.P. (m)</th> <th>配管仕様</th> <th>一次応力+二次応力 (MPa)</th> <th>許容値 0.4Sa (MPa)</th> </tr> </thead> <tbody> <tr> <td>代表配管 (水消火系)</td> <td>3次元はりモデル解析</td> <td>原子炉補助建屋</td> <td>40.3</td> <td>4B Sch40</td> <td>23</td> <td>84</td> </tr> <tr> <td>全評価対象配管</td> <td>標準支持間隔法</td> <td colspan="5">建設時の標準支持間隔若しくは実施工支持間隔が0.4Saを制限とし算出した支持間隔以下であることを確認。</td> </tr> </tbody> </table>	配管	口径 (B)	一次+二次応力 (MPa)					許容値 0.4Sa (MPa)	内圧 応力	自重 応力	地震 応力	二次 応力	合計	水消火系統配管	4	8.6	7.9	5.9	0.0	23	84	配管名	評価方法	建屋	T.P. (m)	配管仕様	一次応力+二次応力 (MPa)	許容値 0.4Sa (MPa)	代表配管 (水消火系)	3次元はりモデル解析	原子炉補助建屋	40.3	4B Sch40	23	84	全評価対象配管	標準支持間隔法	建設時の標準支持間隔若しくは実施工支持間隔が0.4Saを制限とし算出した支持間隔以下であることを確認。					<p>【女川】 記載表現の相違 設計方針の相違</p> <ul style="list-style-type: none"> ・女川は、溢水防護区画内の想定破損除外の適用が必要な配管ラインを特定した上で、3次元はりモデル解析を実施している。 ・泊では、低エネルギー配管については、建設時と同様に、室温との温度差が有意でないとし、熱応力を考慮していない。（大阪と同様） ・一次+二次応力の相違はプラント系統構成による相違。許容値は材質が異なることによる相違。 ・代表配管ブロックについて評価を実施した上で、それ以外の評価対象管については、標準支持間隔法により評価を満足することを確認している。その旨を説明するために表5を作成している。 <p>【玄海】 表の体裁は女川を参照し記載するが、参考として水消火系統配管に対して貫通クラックを想定する評価結果を示す。玄海では、代表配管ブロックのみについて、評価を示している。</p>
建屋	EL. (m)	配管仕様	配管名	一次+二次応力 (MPa)	許容値余 0.4Sa (MPa)																																																																																																																																							
A/B	~19.25	2B-sch40	水消火系統配管	80	85																																																																																																																																							
区画番号	解析モデル (対象ライン)	一次+二次応力 (MPa)					許容値 0.4Sa (MPa)																																																																																																																																					
		内圧 応力	自重 応力	地震 応力	二次 応力	合計																																																																																																																																						
R-2F-1-1	HNCW-41 (50A-HNCW-41)	4	1	74	1	80	100																																																																																																																																					
R-B3F-3	KRR-007 (350A-KRR-2-1) (100A-KRR-24-1) (100A-KRR-33)	30	12	11	28	81	102																																																																																																																																					
	KRR-116 (100A-KRR-24-1)	18	4	19	32	73	102																																																																																																																																					
	R-B3F-6	KRR-012 (350A-KRR-4-1) (100A-KRR-25-1) (100A-KRR-41)	30	11	9	27	77	102																																																																																																																																				
	KRR-146 ^{※1} (100A-KRR-25-1)	18	2	27	38	85	102																																																																																																																																					
R-B3F-7	KRR-017 (350A-KRR-6-1) (300A-KRR-6-2) (100A-KRR-52) (100A-KRR-26-1)	30	11	6	7	54	102																																																																																																																																					
	KRR-146 ^{※1} (100A-KRR-26-1)	18	2	27	38	85	102																																																																																																																																					
	R-B3F-4	LPCS-003 (300A-LPCS-2-1) (50A-LPCS-7) (100A-LPCS-4-1)	21	10	9	11	51	102																																																																																																																																				
	KLPCS-117 (100A-LPCS-4-1)	15	1	16	7	39	102																																																																																																																																					
配管	口径 (B)	一次+二次応力 (MPa)					許容値 0.4Sa (MPa)																																																																																																																																					
		内圧 応力	自重 応力	地震 応力	二次 応力	合計																																																																																																																																						
水消火系統配管	4	8.6	7.9	5.9	0.0	23	84																																																																																																																																					
配管名	評価方法	建屋	T.P. (m)	配管仕様	一次応力+二次応力 (MPa)	許容値 0.4Sa (MPa)																																																																																																																																						
代表配管 (水消火系)	3次元はりモデル解析	原子炉補助建屋	40.3	4B Sch40	23	84																																																																																																																																						
全評価対象配管	標準支持間隔法	建設時の標準支持間隔若しくは実施工支持間隔が0.4Saを制限とし算出した支持間隔以下であることを確認。																																																																																																																																										

赤字：設備、運用又は体制の相違（設計方針の相違）
 青字：記載箇所又は記載内容の相違（記載方針の相違）
 緑字：記載表現、設備名称の相違（実質的な相違なし）

大阪発電所3/4号炉	女川原子力発電所2号炉	泊発電所3号炉	相違理由																																									
	<p>表4 最小裕度となる箇所における応力評価結果(2/2)</p> <table border="1" data-bbox="696 204 1265 539"> <thead> <tr> <th rowspan="2">区画番号</th> <th rowspan="2">解析モデル (対象ライン)</th> <th colspan="4">一次+二次応力 (MPa)</th> <th rowspan="2">許容値 0.4S₀ (MPa)</th> </tr> <tr> <th>内圧 応力</th> <th>自重 応力</th> <th>地震 応力</th> <th>二次 応力</th> </tr> </thead> <tbody> <tr> <td rowspan="2">R-B3F-5</td> <td>HPCS-003 (300A-HPCS-2-1) (100A-HPCS-6-1)</td> <td>34</td> <td>5</td> <td>4</td> <td>10</td> <td>53</td> <td>102</td> </tr> <tr> <td>KHPCS-001 (100A-HPCS-6-1)</td> <td>28</td> <td>1</td> <td>16</td> <td>3</td> <td>48</td> <td>102</td> </tr> <tr> <td rowspan="2">R-B3F-2</td> <td>RCIC-002 (100A-RCIC-2-1) (100A-RCIC-3-1) (50A-RCIC-5)</td> <td>25</td> <td>21</td> <td>21</td> <td>3</td> <td>70</td> <td>102</td> </tr> <tr> <td>KRCIC-121 (50A-RCIC-5)</td> <td>15</td> <td>47</td> <td>16</td> <td>12</td> <td>90</td> <td>102</td> </tr> </tbody> </table> <p>※1 KMR-146については、R-B3F-6及びR-B3F-7の両区画内で最小裕度となる箇所の評価結果を記載する。</p>	区画番号	解析モデル (対象ライン)	一次+二次応力 (MPa)				許容値 0.4S ₀ (MPa)	内圧 応力	自重 応力	地震 応力	二次 応力	R-B3F-5	HPCS-003 (300A-HPCS-2-1) (100A-HPCS-6-1)	34	5	4	10	53	102	KHPCS-001 (100A-HPCS-6-1)	28	1	16	3	48	102	R-B3F-2	RCIC-002 (100A-RCIC-2-1) (100A-RCIC-3-1) (50A-RCIC-5)	25	21	21	3	70	102	KRCIC-121 (50A-RCIC-5)	15	47	16	12	90	102		<p>【女川】</p> <p><u>記載表現の相違</u></p> <p><u>設計方針の相違</u></p> <ul style="list-style-type: none"> ・女川は、溢水防護区画内の想定破損除外の適用が必要な配管ラインを特定した上で、3次元はりモデル解析を実施している。 ・一次+二次応力の相違はプラント系統構成による相違。許容値は材質が異なることによる相違。
区画番号	解析モデル (対象ライン)			一次+二次応力 (MPa)					許容値 0.4S ₀ (MPa)																																			
		内圧 応力	自重 応力	地震 応力	二次 応力																																							
R-B3F-5	HPCS-003 (300A-HPCS-2-1) (100A-HPCS-6-1)	34	5	4	10	53	102																																					
	KHPCS-001 (100A-HPCS-6-1)	28	1	16	3	48	102																																					
R-B3F-2	RCIC-002 (100A-RCIC-2-1) (100A-RCIC-3-1) (50A-RCIC-5)	25	21	21	3	70	102																																					
	KRCIC-121 (50A-RCIC-5)	15	47	16	12	90	102																																					

赤字：設備、運用又は体制の相違（設計方針の相違）
 青字：記載箇所又は記載内容の相違（記載方針の相違）
 緑字：記載表現、設備名称の相違（実質的な相違なし）

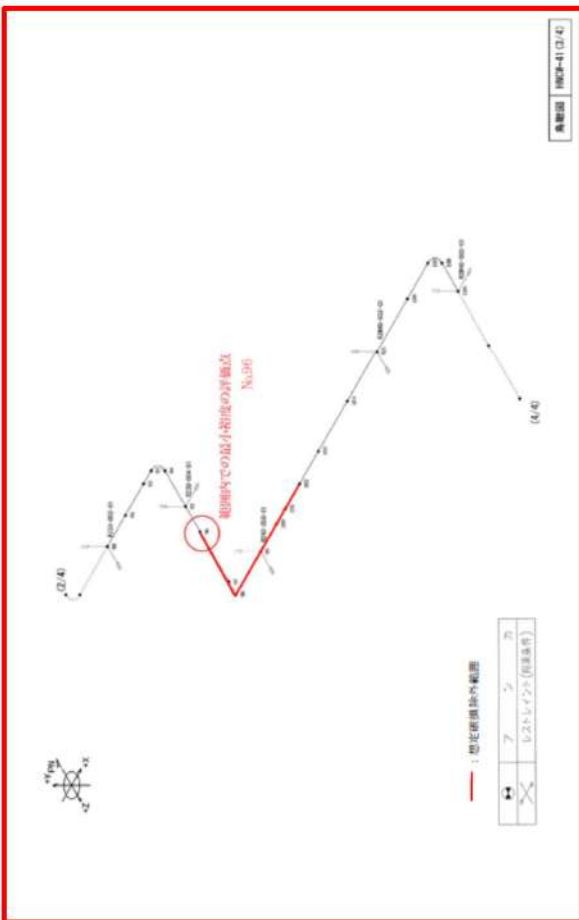
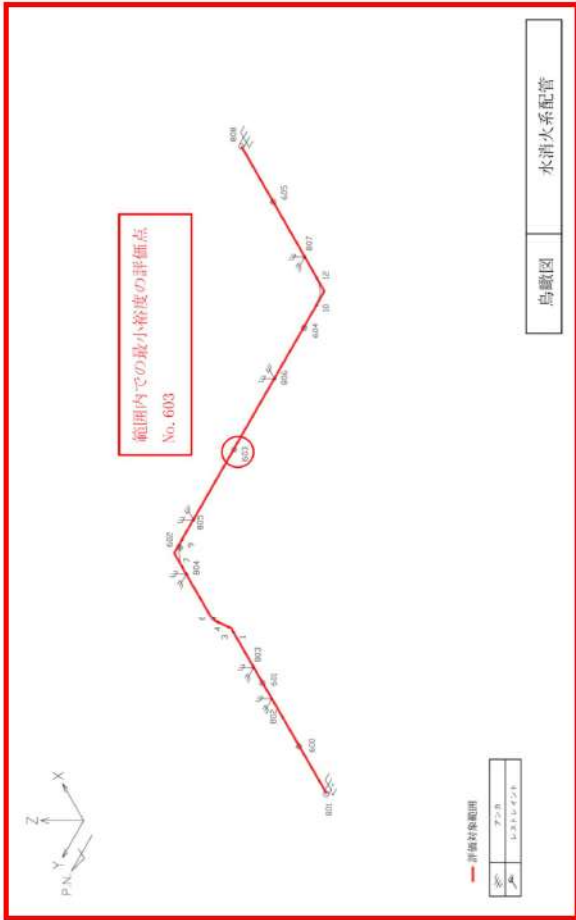
大阪発電所3/4号炉	女川原子力発電所2号炉	泊発電所3号炉	相違理由
	 <p data-bbox="772 1129 1187 1157">図1 HNCW-41 解析モデル図（最小裕度の範囲）</p>	 <p data-bbox="1339 1129 1803 1157">図2 水消火系配管 解析モデル図（最小裕度の範囲）</p>	<p data-bbox="1872 177 2132 268">【女川】 設計方針の相違 応力評価の対象とした系統の相違</p> <p data-bbox="1872 858 1993 917">【女川】 記載表現の相違</p>

赤字：設備、運用又は体制の相違（設計方針の相違）
 青字：記載箇所又は記載内容の相違（記載方針の相違）
 緑字：記載表現、設備名称の相違（実質的な相違なし）

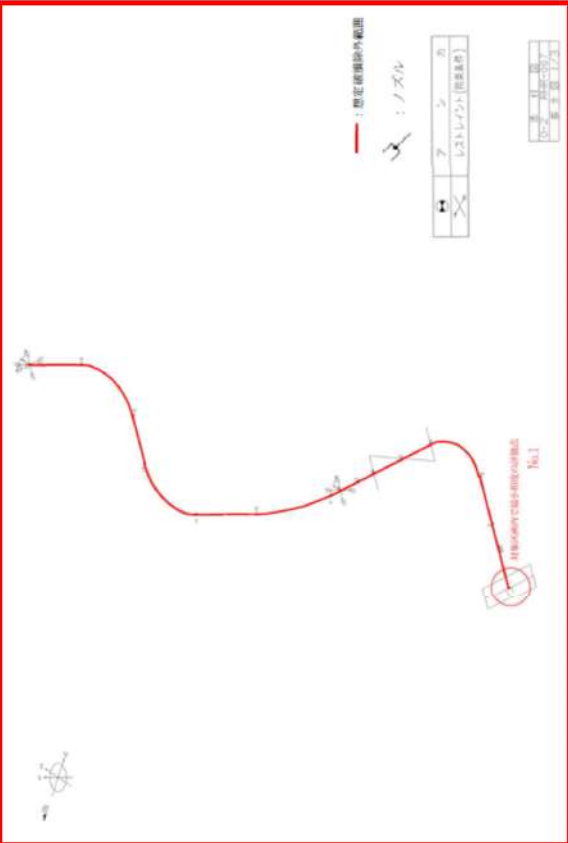
大阪発電所3/4号炉	女川原子力発電所2号炉	泊発電所3号炉	相違理由
	 <p data-bbox="779 1061 1187 1093">図2 RHR-007 解析モデル図（最小裕度の範囲）</p>		<p data-bbox="1877 178 1937 199">【女川】</p> <p data-bbox="1877 215 2004 236">設計方針の相違</p> <p data-bbox="1877 247 2128 268">応力評価の対象とした系統の相違</p>

赤字：設備、運用又は体制の相違（設計方針の相違）
 青字：記載箇所又は記載内容の相違（記載方針の相違）
 緑字：記載表現、設備名称の相違（実質的な相違なし）

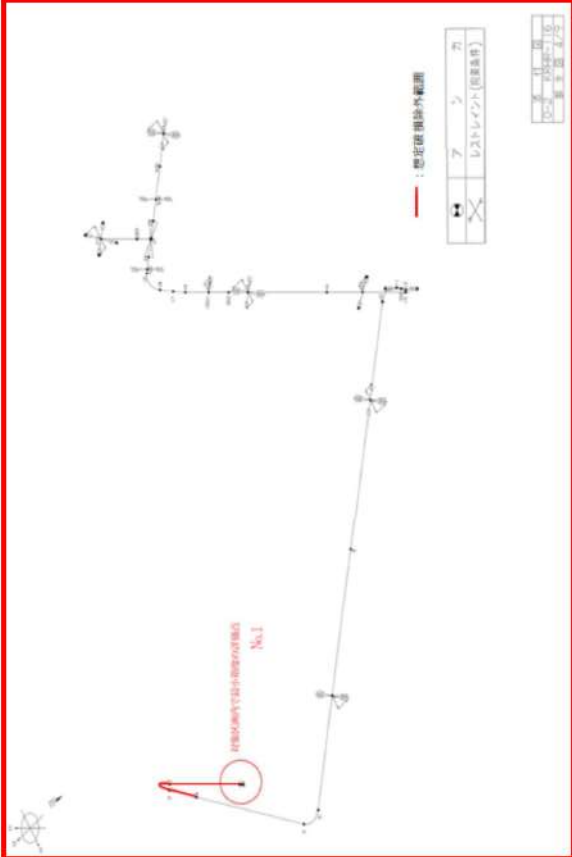
大阪発電所3/4号炉	女川原子力発電所2号炉	泊発電所3号炉	相違理由
	 <p data-bbox="770 1066 1189 1086">図3 KRHR-116 解析モデル図 (最小裕度の範囲)</p>		<p data-bbox="1874 180 1928 201">【女川】</p> <p data-bbox="1874 217 1995 237">設計方針の相違</p> <p data-bbox="1874 248 2130 269">応力評価の対象とした系統の相違</p>

赤字：設備、運用又は体制の相違（設計方針の相違）
 青字：記載箇所又は記載内容の相違（記載方針の相違）
 緑字：記載表現、設備名称の相違（実質的な相違なし）

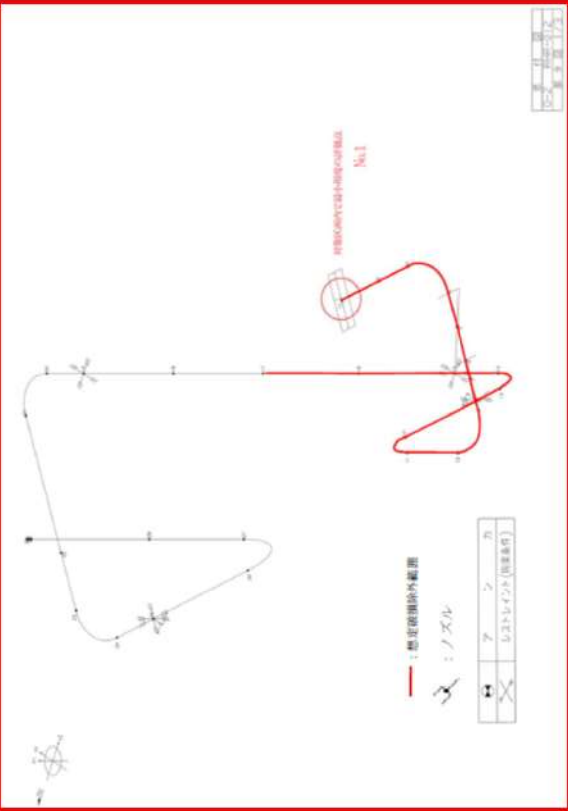
大阪発電所3/4号炉	女川原子力発電所2号炉	泊発電所3号炉	相違理由
	 <p data-bbox="779 1034 1191 1056">図4 RHR-012 解析モデル図（最小裕度の範囲）</p>		<p data-bbox="1881 178 1937 201">【女川】</p> <p data-bbox="1881 217 2004 239">設計方針の相違</p> <p data-bbox="1881 248 2134 271">応力評価の対象とした系統の相違</p>

赤字：設備、運用又は体制の相違（設計方針の相違）
 青字：記載箇所又は記載内容の相違（記載方針の相違）
 緑字：記載表現、設備名称の相違（実質的な相違なし）

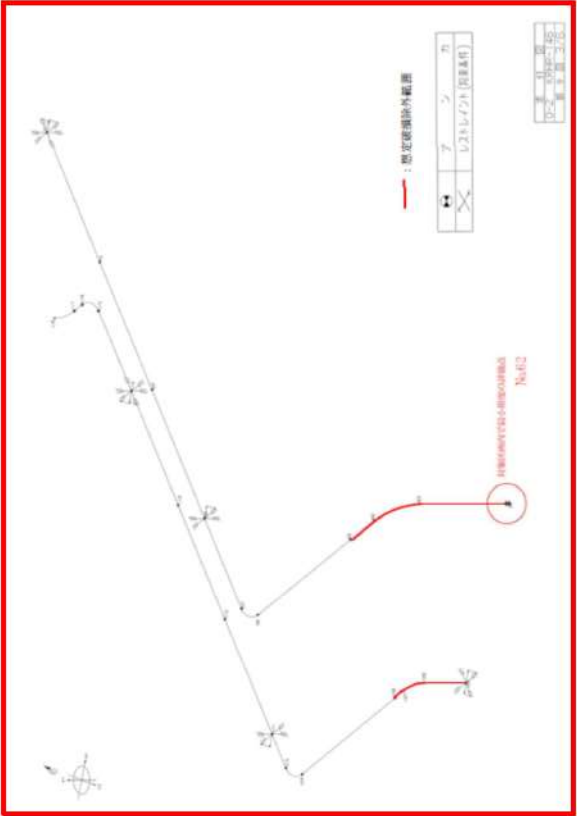
大阪発電所3/4号炉	女川原子力発電所2号炉	泊発電所3号炉	相違理由
	 <p data-bbox="770 1029 1191 1054">図5 KRHR-146 解析モデル図（最小裕度の範囲）</p>		<p data-bbox="1877 178 1930 201">【女川】</p> <p data-bbox="1877 213 1995 236">設計方針の相違</p> <p data-bbox="1877 248 2130 271">応力評価の対象とした系統の相違</p>

赤字：設備、運用又は体制の相違（設計方針の相違）
 青字：記載箇所又は記載内容の相違（記載方針の相違）
 緑字：記載表現、設備名称の相違（実質的な相違なし）

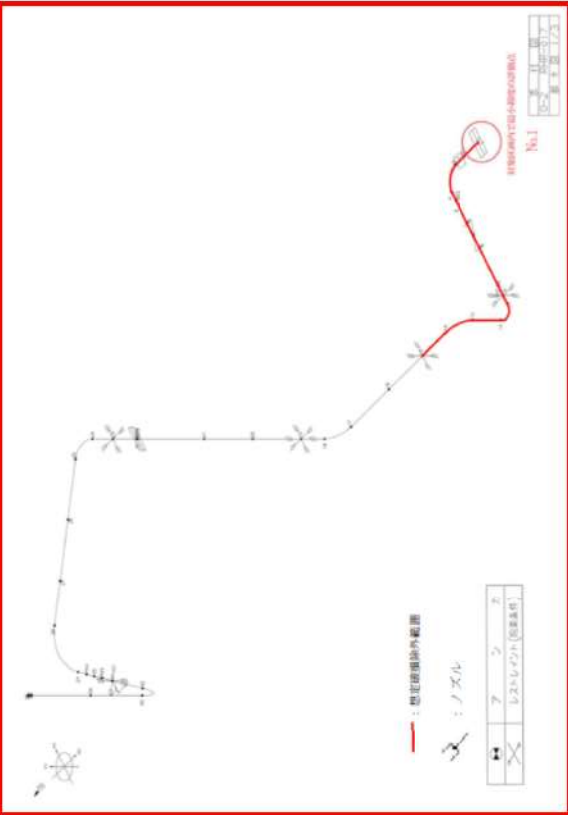
大阪発電所3/4号炉	女川原子力発電所2号炉	泊発電所3号炉	相違理由
	 <p data-bbox="779 1031 1191 1056">図6 RHR-017 解析モデル図（最小裕度の範囲）</p>		<p data-bbox="1877 178 1930 204">【女川】</p> <p data-bbox="1877 213 1998 239">設計方針の相違</p> <p data-bbox="1877 248 2134 274">応力評価の対象とした系統の相違</p>

赤字：設備、運用又は体制の相違（設計方針の相違）
 青字：記載箇所又は記載内容の相違（記載方針の相違）
 緑字：記載表現、設備名称の相違（実質的な相違なし）

大阪発電所3/4号炉	女川原子力発電所2号炉	泊発電所3号炉	相違理由
	 <p data-bbox="770 1066 1191 1088">図7 LPCS-003 解析モデル図（最小裕度の範囲）</p>		<p data-bbox="1877 181 1930 204">【女川】</p> <p data-bbox="1877 217 1998 239">設計方針の相違</p> <p data-bbox="1877 252 2130 274">応力評価の対象とした系統の相違</p>

赤字：設備、運用又は体制の相違（設計方針の相違）
 青字：記載箇所又は記載内容の相違（記載方針の相違）
 緑字：記載表現、設備名称の相違（実質的な相違なし）

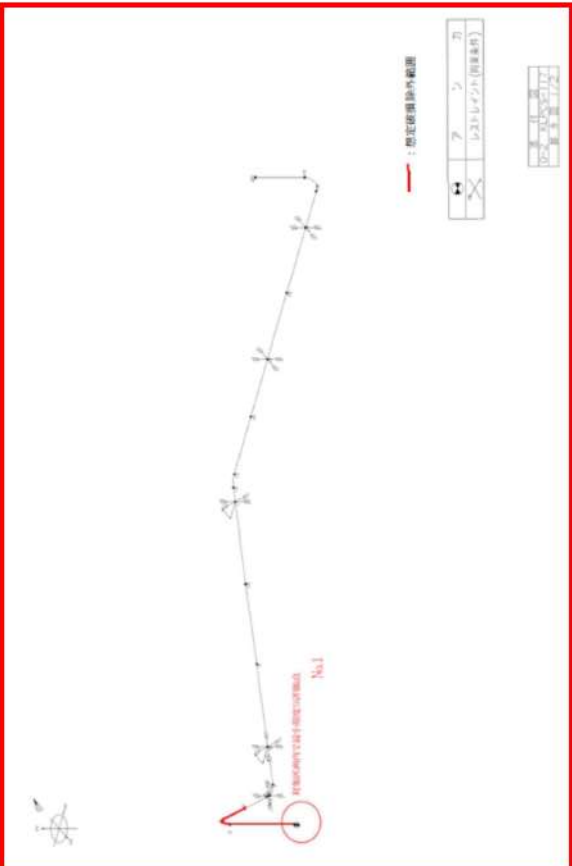
大阪発電所3/4号炉	女川原子力発電所2号炉	泊発電所3号炉	相違理由
	 <p data-bbox="761 1061 1198 1093">図8 KLPCS-117 解析モデル図（最小裕度の範囲）</p>		<p data-bbox="1870 175 1937 199">【女川】</p> <p data-bbox="1870 215 2004 239">設計方針の相違</p> <p data-bbox="1870 247 2128 271">応力評価の対象とした系統の相違</p>

赤字：設備、運用又は体制の相違（設計方針の相違）
 青字：記載箇所又は記載内容の相違（記載方針の相違）
 緑字：記載表現、設備名称の相違（実質的な相違なし）

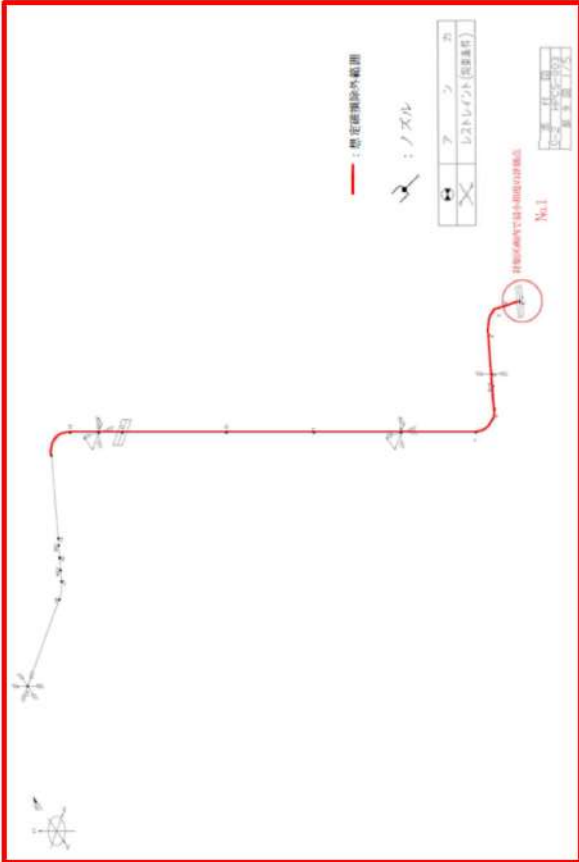
大阪発電所3/4号炉	女川原子力発電所2号炉	泊発電所3号炉	相違理由
	 <p data-bbox="768 1066 1189 1090">図9 HPCS-003 解析モデル図（最小裕度の範囲）</p>		<p data-bbox="1872 180 1933 201">【女川】</p> <p data-bbox="1872 217 1995 237">設計方針の相違</p> <p data-bbox="1872 248 2130 269">応力評価の対象とした系統の相違</p>

赤字：設備、運用又は体制の相違（設計方針の相違）
 青字：記載箇所又は記載内容の相違（記載方針の相違）
 緑字：記載表現、設備名称の相違（実質的な相違なし）

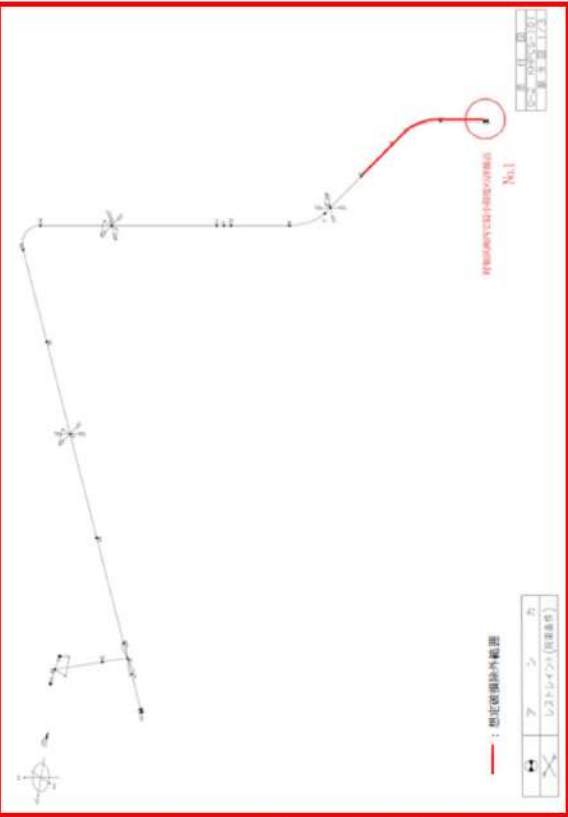
大阪発電所3/4号炉	女川原子力発電所2号炉	泊発電所3号炉	相違理由
	 <p data-bbox="757 1034 1205 1056">図10 KHPCS-001 解析モデル図（最小裕度の範囲）</p>		<p data-bbox="1877 178 1930 201">【女川】</p> <p data-bbox="1877 213 1998 236">設計方針の相違</p> <p data-bbox="1877 248 2130 271">応力評価の対象とした系統の相違</p>

赤字：設備、運用又は体制の相違（設計方針の相違）
 青字：記載箇所又は記載内容の相違（記載方針の相違）
 緑字：記載表現、設備名称の相違（実質的な相違なし）

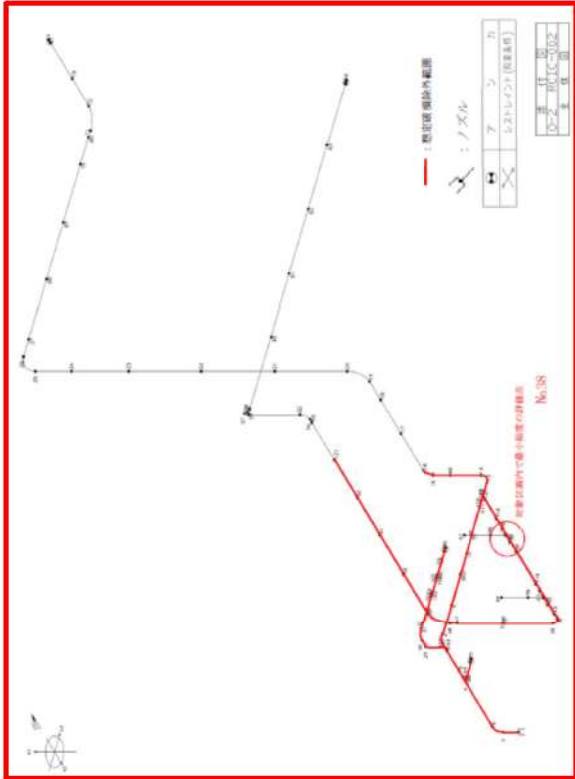
大阪発電所3/4号炉	女川原子力発電所2号炉	泊発電所3号炉	相違理由
	 <p data-bbox="763 960 1196 983">図11 RCIC-002 解析モデル図（最小裕度の範囲）</p>		<p data-bbox="1872 178 1928 197">【女川】</p> <p data-bbox="1872 213 1991 233">設計方針の相違</p> <p data-bbox="1872 245 2121 264">応力評価の対象とした系統の相違</p>

赤字：設備、運用又は体制の相違（設計方針の相違）
 青字：記載箇所又は記載内容の相違（記載方針の相違）
 緑字：記載表現、設備名称の相違（実質的な相違なし）

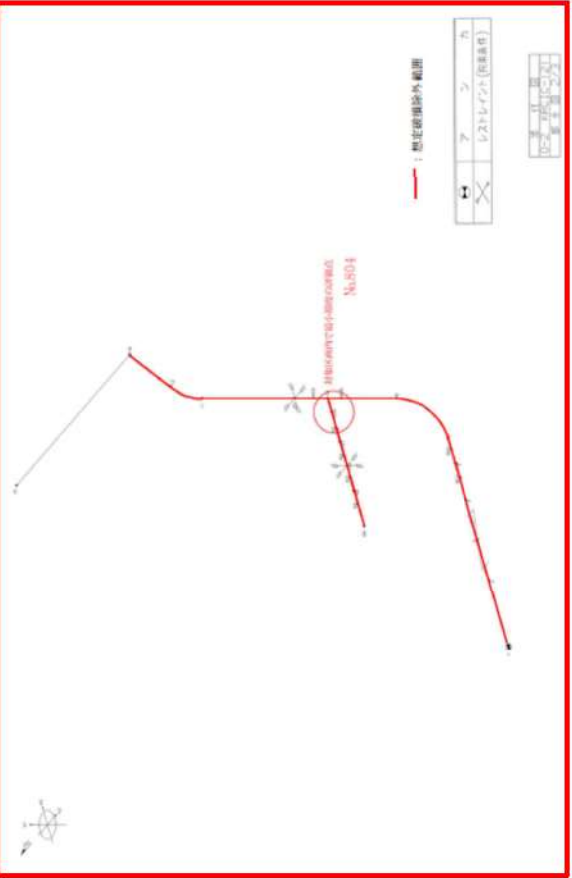
大阪発電所3/4号炉	女川原子力発電所2号炉	泊発電所3号炉	相違理由
	 <p data-bbox="757 1098 1205 1125">図12 KRCIC-121 解析モデル図（最小裕度の範囲）</p>		<p data-bbox="1874 178 1937 199">【女川】</p> <p data-bbox="1874 215 2004 236">設計方針の相違</p> <p data-bbox="1874 247 2134 268">応力評価の対象とした系統の相違</p>

赤字：設備、運用又は体制の相違（設計方針の相違）
 青字：記載箇所又は記載内容の相違（記載方針の相違）
 緑字：記載表現、設備名称の相違（実質的な相違なし）

大阪発電所3/4号炉	女川原子力発電所2号炉	泊発電所3号炉	相違理由
<p style="text-align: right;">補足資料 10</p> <p>1. 減肉管理の概要</p> <p>「原子力発電所の内部溢水影響評価ガイド」では、「2.2 減肉等による破損」の想定にあたっては、「注2）設計や管理と破損の想定について」のただし書きとして、「減肉対策として当該部分の肉厚の測定を非破壊検査によって定期的に実施している等、当該部位の材料のき裂状況及び減肉状況を定期的に直接把握している場合は、破損による漏えいを確実に防止できることから、破損を想定しなくてもよい。」とあり、既に減肉状況を定期的に把握している系統配管については、減肉等による破損の想定にはあたらない。</p> <p>一方、減肉等による破損の想定を除外した系統配管については、これまでも減肉知見の拡充の観点より定期的な肉厚検査、配管の対策材への取替等を行ってきており、破損による漏えいを確実に防止できるものと判断しているが、今後も、現状検査範囲の継続的な監視を行うとともに、さらなる検査範囲の拡充を行っている。</p> <p>2. 検査範囲の拡充に伴うデータの扱い</p> <p>減肉は一定の期間内に進行した板厚の減少であるが、以下の理由から減肉かどうかの判断が容易でない場合が含まれている。</p> <ul style="list-style-type: none"> ・製造時の板厚は公称値で調達されており、公差が含まれている。 ・そのため、最初の計測等では板厚減少の原因が加工時の公差によるもの（進行性はない）か、減肉によるものか判断できないものも含まれている。 ・そこで、現状の減肉管理では加工時の公差による板厚減少も減肉と一旦仮定し、複数回の測定を行っている。加工による板厚減少であれば評価上の減肉速度は測定により低下、余寿命はのびるため、減肉を判断することができる。 ・次頁以降に減肉等による破損の想定を除外した系統配管の保全状況の確認結果を示す。 	<p style="text-align: right;">添付資料 16</p> <p>減肉等による破損評価について</p> <p>添付資料 14、15 の評価結果により想定破損除外を行う場合は、減肉、腐食、疲労による破損を別途想定し、非破壊検査、疲労評価等を定期的に実施し、定期的な管理を実施することにより、減肉による破損の想定を除外する。</p> <p>1. 配管の想定破損評価時の配管減肉の管理方針について</p> <p>女川2号炉において減肉の可能性のある配管について、当社は「発電用原子力設備規格 沸騰水型原子力発電所配管減肉管理に関する技術規格（2006年版）（JSME S NH1-2006）」（以下「JSME規格」という。）に基づいて管理している。</p> <p>ここで、内部溢水影響評価において想定破損を除外する配管については、必ずしも上記の測定対象とならないことから、減肉の有無を確認し、今後の運用において減肉等による破損がないこととする。</p> <p>また、当該の配管については、内部溢水ガイド附属書Aの「2.1 運転中に発生する応力に基づく評価法」の要求を満足させることとする。</p> <p>なお、本事項は、後段規制での対応が必要となる事項である。（別添2 参照）</p>	<p style="text-align: right;">添付資料 15</p> <p>減肉等による破損評価について</p> <p>添付資料 13、14 の評価結果により想定破損除外又は高エネルギー配管の貫通クラックを適用する場合は、減肉、腐食、疲労による破損を別途想定し、非破壊検査、疲労評価等を定期的に実施し、定期的な管理を実施することにより、減肉による破損の想定を除外又は高エネルギー配管において貫通クラックを適用する。</p> <p>1. 配管の想定破損評価時の配管減肉の管理方針について</p> <p>泊発電所3号炉において減肉の可能性のある配管について、当社は「発電用原子力設備規格 加圧水型原子力発電所配管減肉管理に関する技術規格（2006年版）（JSME S NG1-2006）」（以下「JSME規格」という。）に基づいて管理している。</p> <p>ここで、内部溢水影響評価において想定破損を除外する配管及び高エネルギー配管の貫通クラックを適用する配管については、必ずしも上記の測定対象とならないことから、減肉の有無を確認し、今後の運用において減肉等による破損がないこととする。</p> <p>また、当該の配管については、内部溢水ガイド附属書Aの「2.1 運転中に発生する応力に基づく評価法」の要求を満足させることとする。</p> <p>なお、本事項は、後段規制での対応が必要となる事項である。（別添2 参照）</p>	<p>【大阪】</p> <p>記載方針の相違 女川審査実績の反映</p> <p>【女川】</p> <p>記載表現の相違 設計方針の相違</p> <p>泊では、高エネルギー配管について、貫通クラックを適用している系統がある。（大阪と同様）</p> <p>記載方針の相違 高エネルギー配管の貫通クラックを記載したことによる記載の相違。先行プラントにおいて同様の記載がないことから、左記のとおり記載した。</p> <p>【女川】</p> <p>記載表現の相違 炉型の違いによる規格の相違。</p> <p>【女川】</p> <p>設計方針の相違</p> <p>泊では、高エネルギー配管について、貫通クラックを適用している系統がある。（大阪と同様）</p> <p>記載方針の相違 高エネルギー配管の貫通クラックを記載したことによる記載の相違。先行プラントにおいて同様の記載がないことから、左記のとおり記載した。</p>

赤字：設備、運用又は体制の相違（設計方針の相違）
 青字：記載箇所又は記載内容の相違（記載方針の相違）
 緑字：記載表現、設備名称の相違（実質的な相違なし）

大阪発電所3/4号炉	女川原子力発電所2号炉	泊発電所3号炉	相違理由
<p>4. 代表部位の選定と検査計画</p> <p>(1) 考え方</p> <p>代表系統及び部位の測定は JSME の減肉管理の考え方を踏まえて決定している。考え方を図1に示す。</p> <div data-bbox="114 331 680 986" style="border: 1px solid black; padding: 5px;"> <p>代表系統及び部位の選定</p> <p>JSME S NG1-2006: 発電用設備規格 加圧水型原子力発電所配管減肉管理に関する技術規格</p> <p>注目するパラメータ：流体条件×偏流発生部位×材質</p> <p>↓</p> <p>管理対象外（減肉のリスク低）</p> <p>さらに</p> <p>↓</p> <p>想定破損：軽微な減肉量を計測できるよう考慮</p> <p>↓</p> <div style="display: flex; justify-content: space-between;"> <div style="border: 1px solid black; padding: 2px;"> <p>流体条件</p> <p>高温配管：想定破損の対象は補助蒸気配管のみ</p> <p>低温配管：脱塩、溶存酸素、pHを考慮してそれぞれから選定</p> </div> <div style="border: 1px solid black; padding: 2px;"> <p>偏流発生部位など</p> <ul style="list-style-type: none"> • 流れがない系統及び流れのある系統に共通 減肉量が小さいため形状変化の影響を受けにくい直管部を対象 • 流れがある系統 偏流発生部位のエルボ部も対象 </div> </div> </div> <p>図1 代表系統及び部位の考え方</p> <p>(2) 高エネルギー配管</p> <p>減肉管理対象の考え方に沿って、具体的に以下の代表系統と部位を選定する。</p> <ul style="list-style-type: none"> ・ 系統 補助蒸気配管 ・ 部位 流れあり：直管部、エルボ部 <p>(3) 低エネルギー配管</p> <ul style="list-style-type: none"> ・ 流れのある腐食：直管部、エルボ部 ・ 流れのない腐食：直管部 	<p>2. 検討対象系統の抽出及び腐食モード等の検討</p> <p>(1) 対象系統</p> <p>想定破損を除外する系統のうち、定期事業者検査において非破壊検査による配管肉厚測定を実施している HS 及び HSCR は除外とし、これ以外の減肉量を直接かつ定期的に管理していない系統を対象とする。</p>	<p>2. 検討対象系統の抽出及び腐食モード等の検討</p> <p>(1) 対象系統</p> <p>想定破損を除外する系統及び高エネルギー配管において貫通クラックを適用する系統のうち、定期事業者検査において非破壊検査による配管肉厚測定を実施している補助蒸気系、蒸気発生器ブローダウン系（主蒸気管室外）、主蒸気系（主蒸気管室外）、補助給水系、空調用冷水系及び原子炉補機冷却水系は除外とし、これ以外の減肉量を直接かつ定期的に管理していない系統を対象とする。</p>	<p>相違理由</p> <p>【女川】</p> <p><u>設計方針の相違</u></p> <ul style="list-style-type: none"> ・ 泊では、高エネルギー配管について、貫通クラックを適用している系統がある。（大阪と同様） ・ プラント設計による系統の相違 <p><u>記載方針の相違</u></p> <p>高エネルギー配管の貫通クラックを記載したことによる記載の相違。先行プラントにおいて同様の記載がないことから、左記のとおり記載した。</p> <p>【大阪】</p> <p><u>記載方針の相違</u></p> <p>女川審査実績を反映し、女川と同様の内容にて検討対象系統を抽出する。</p>

赤字：設備、運用又は体制の相違（設計方針の相違）
 青字：記載箇所又は記載内容の相違（記載方針の相違）
 緑字：記載表現、設備名称の相違（実質的な相違なし）

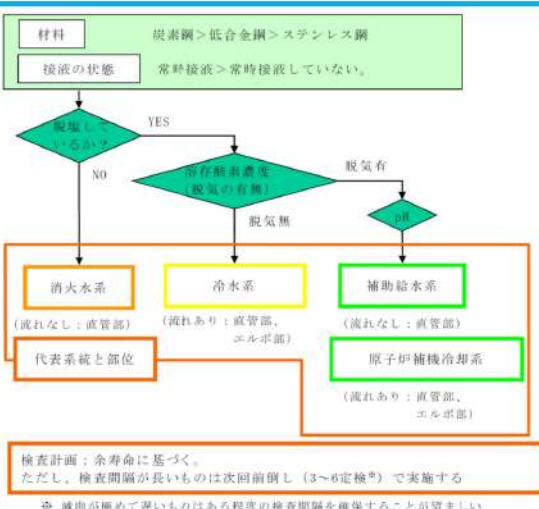
大阪発電所3/4号炉	女川原子力発電所2号炉	泊発電所3号炉	相違理由																								
 <p>図2 代表系統及び部位の選定</p>	<p>(2) 材料 女川2号炉の内部溢水影響評価において想定破損を除外する配管は、すべて炭素鋼配管である。</p> <p>【柏崎刈羽6, 7号炉】 まとめ資料9条-別添1-補足19-12より抜粋</p> <p>(2)対象材料 柏崎刈羽原子力発電所6号炉、7号炉の低エネルギー配管材料としては、ステンレス鋼および炭素鋼が使用されているが、配管の主要な減肉事象を補足第19.2.2-1表のとおり整理し、相対的に耐食性の低い炭素鋼配管を代表として抽出する。補足第19.2.2-1表に主要な減肉事象と炭素鋼配管を代表として減肉測定を実施する理由を示す。なお、炭素鋼配管であっても、海水系統のような内面ライニング配管については、対象外とする。</p> <table border="1" data-bbox="705 726 1243 981"> <caption>補足第19.2.2-1表 主要な減肉事象と炭素鋼配管を代表として減肉測定を実施する理由</caption> <thead> <tr> <th>減肉事象</th> <th>炭素鋼配管を代表として減肉測定を実施する理由</th> </tr> </thead> <tbody> <tr> <td>全面腐食</td> <td>ステンレス鋼はCr含有量が多く、表面に形成される不動態化被膜により炭素鋼に比べ耐食性が優れている。</td> </tr> <tr> <td>流れ加速型腐食 (FAC)</td> <td>FACによる減肉速度は配管材料のCr含有量が多いほど低下することが知られており、ステンレス鋼は炭素鋼に比べ、FACが抑制される。</td> </tr> <tr> <td>液滴衝撃エロージョン (フラッシング・エロージョン含む)</td> <td>液滴衝撃エロージョンは負圧機器に接続され連続的に高速二相流が流れる系統で発生する可能性があるが、対象となる低エネルギー配管で該当する系統はない。</td> </tr> <tr> <td>キャビテーション・エロージョン</td> <td>設計段階においてキャビテーション発生防止のための評価・確認を実施し、運転条件を適切に維持していることから、問題ない。</td> </tr> <tr> <td>固体粒子エロージョン</td> <td>BWRプラントにおいて通常起こりえない事象である。</td> </tr> </tbody> </table>	減肉事象	炭素鋼配管を代表として減肉測定を実施する理由	全面腐食	ステンレス鋼はCr含有量が多く、表面に形成される不動態化被膜により炭素鋼に比べ耐食性が優れている。	流れ加速型腐食 (FAC)	FACによる減肉速度は配管材料のCr含有量が多いほど低下することが知られており、ステンレス鋼は炭素鋼に比べ、FACが抑制される。	液滴衝撃エロージョン (フラッシング・エロージョン含む)	液滴衝撃エロージョンは負圧機器に接続され連続的に高速二相流が流れる系統で発生する可能性があるが、対象となる低エネルギー配管で該当する系統はない。	キャビテーション・エロージョン	設計段階においてキャビテーション発生防止のための評価・確認を実施し、運転条件を適切に維持していることから、問題ない。	固体粒子エロージョン	BWRプラントにおいて通常起こりえない事象である。	<p>(2) 対象材料 泊発電所3号炉の高エネルギー配管材料及び低エネルギー配管材料としては、ステンレス鋼及び炭素鋼が使用されているが、配管の主要な減肉事象を表1のとおり整理し、相対的に耐食性の低い炭素鋼配管を代表として抽出する。表1に主要な減肉事象と炭素鋼配管を代表として減肉測定を実施する理由を示す。なお、炭素鋼配管であっても、海水系統のような内面ライニング配管のうち損傷状態を非破壊検査によって定期的に確認している部位については、対象外とする。</p> <p>表1 主要な減肉事象と炭素鋼配管を代表として減肉測定を実施する理由</p> <table border="1" data-bbox="1288 790 1848 1045"> <thead> <tr> <th>減肉事象</th> <th>炭素鋼配管を代表として減肉測定を実施する理由</th> </tr> </thead> <tbody> <tr> <td>全面腐食</td> <td>ステンレス鋼はCr含有量が多く、表面に形成される不動態化被膜により炭素鋼に比べ耐食性が優れている。</td> </tr> <tr> <td>流れ加速型腐食 (FAC)</td> <td>FACによる減肉速度は配管材料のCr含有量が多いほど低下することが知られており、ステンレス鋼は炭素鋼に比べ、FACが抑制される。</td> </tr> <tr> <td>液滴衝撃エロージョン (フラッシング・エロージョン含む)</td> <td>液滴衝撃エロージョンは負圧機器に接続され連続的に高速二相流が流れる系統で発生する可能性があるが、対象となる低エネルギー配管で該当する系統はない。</td> </tr> <tr> <td>キャビテーション・エロージョン</td> <td>設計段階においてキャビテーション発生防止のための評価・確認を実施し、運転条件を適切に維持していることから、問題ない。</td> </tr> <tr> <td>固体粒子エロージョン</td> <td>BWRプラントにおいて通常起こりえない事象である。</td> </tr> </tbody> </table>	減肉事象	炭素鋼配管を代表として減肉測定を実施する理由	全面腐食	ステンレス鋼はCr含有量が多く、表面に形成される不動態化被膜により炭素鋼に比べ耐食性が優れている。	流れ加速型腐食 (FAC)	FACによる減肉速度は配管材料のCr含有量が多いほど低下することが知られており、ステンレス鋼は炭素鋼に比べ、FACが抑制される。	液滴衝撃エロージョン (フラッシング・エロージョン含む)	液滴衝撃エロージョンは負圧機器に接続され連続的に高速二相流が流れる系統で発生する可能性があるが、対象となる低エネルギー配管で該当する系統はない。	キャビテーション・エロージョン	設計段階においてキャビテーション発生防止のための評価・確認を実施し、運転条件を適切に維持していることから、問題ない。	固体粒子エロージョン	BWRプラントにおいて通常起こりえない事象である。	<p>【女川】 記載表現の相違 記載方針の相違 柏崎審査実績を反映。</p> <p>【柏崎】 設備名称の相違 設計方針の相違 泊については高エネルギー配管も応力評価の対象としているため、その旨を反映している。(高エネルギー配管に応力評価を実施しているという観点で、大阪、女川と同様)</p> <p>記載方針の相違 内面ライニング配管については、「損傷状態を非破壊検査によって定期的に確認している部位については、破損の想定を除外することはできる」と溢水ガイドで定められているため、その旨を記載している。</p>
減肉事象	炭素鋼配管を代表として減肉測定を実施する理由																										
全面腐食	ステンレス鋼はCr含有量が多く、表面に形成される不動態化被膜により炭素鋼に比べ耐食性が優れている。																										
流れ加速型腐食 (FAC)	FACによる減肉速度は配管材料のCr含有量が多いほど低下することが知られており、ステンレス鋼は炭素鋼に比べ、FACが抑制される。																										
液滴衝撃エロージョン (フラッシング・エロージョン含む)	液滴衝撃エロージョンは負圧機器に接続され連続的に高速二相流が流れる系統で発生する可能性があるが、対象となる低エネルギー配管で該当する系統はない。																										
キャビテーション・エロージョン	設計段階においてキャビテーション発生防止のための評価・確認を実施し、運転条件を適切に維持していることから、問題ない。																										
固体粒子エロージョン	BWRプラントにおいて通常起こりえない事象である。																										
減肉事象	炭素鋼配管を代表として減肉測定を実施する理由																										
全面腐食	ステンレス鋼はCr含有量が多く、表面に形成される不動態化被膜により炭素鋼に比べ耐食性が優れている。																										
流れ加速型腐食 (FAC)	FACによる減肉速度は配管材料のCr含有量が多いほど低下することが知られており、ステンレス鋼は炭素鋼に比べ、FACが抑制される。																										
液滴衝撃エロージョン (フラッシング・エロージョン含む)	液滴衝撃エロージョンは負圧機器に接続され連続的に高速二相流が流れる系統で発生する可能性があるが、対象となる低エネルギー配管で該当する系統はない。																										
キャビテーション・エロージョン	設計段階においてキャビテーション発生防止のための評価・確認を実施し、運転条件を適切に維持していることから、問題ない。																										
固体粒子エロージョン	BWRプラントにおいて通常起こりえない事象である。																										
	<p>(3) 腐食モード 配管強度に影響をおよぼす腐食モードとしては、流れ加速型腐食 (FAC)、全面腐食が考えられるが、低温配管については、FACの感受性が低いことから、主に全面腐食を検討する。</p>	<p>(3) 腐食モード 配管強度に影響をおよぼす腐食モードとしては、流れ加速型腐食 (FAC)、全面腐食が考えられるが、低温配管については、FACの感受性が低いことから、主に全面腐食を検討する。</p>	<p>【大阪】 記載方針の相違 柏崎審査実績を反映し、女川と同様に材料、腐食モード及び水質の観点から検討対象系統を抽出する。</p>																								

赤字：設備、運用又は体制の相違（設計方針の相違）
 青字：記載箇所又は記載内容の相違（記載方針の相違）
 緑字：記載表現、設備名称の相違（実質的な相違なし）

大阪発電所3/4号炉	女川原子力発電所2号炉	泊発電所3号炉	相違理由																				
	<p>(4) 水質</p> <p>炭素鋼の全面腐食の加速因子として支配的なものは、溶存酸素、pH、塩分濃度、水質条件である。想定破損を除外する系統の水質は、純水タンク、復水貯蔵タンク、サブプレッションプールである。</p> <p>以上の検討結果より肉厚測定対象系統及び肉厚測定箇所の考え方を表1に示し、また肉厚測定箇所を図1～図6に示す。</p> <p>表1 肉厚測定対象系統及び肉厚測定箇所の考え方</p> <table border="1" data-bbox="696 555 1267 740"> <thead> <tr> <th>肉厚測定対象系統</th> <th>系統概要</th> <th>肉厚測定箇所</th> </tr> </thead> <tbody> <tr> <td>HNCW</td> <td>内包水は純水であり、防食剤を含む定常的な流れのある系統</td> <td rowspan="5">想定破損を除外する範囲において、減肉が想定される箇所（配管エルボ部、ポンプ吐出など）を選定</td> </tr> <tr> <td>BHR</td> <td></td> </tr> <tr> <td>LPCS</td> <td>内包水は復水であり、防食剤を含まず、定常的な流れがない系統（系統試験時は流れあり）。</td> </tr> <tr> <td>HPCS</td> <td></td> </tr> <tr> <td>RCIC</td> <td></td> </tr> </tbody> </table>	肉厚測定対象系統	系統概要	肉厚測定箇所	HNCW	内包水は純水であり、防食剤を含む定常的な流れのある系統	想定破損を除外する範囲において、減肉が想定される箇所（配管エルボ部、ポンプ吐出など）を選定	BHR		LPCS	内包水は復水であり、防食剤を含まず、定常的な流れがない系統（系統試験時は流れあり）。	HPCS		RCIC		<p>(4) 水質</p> <p>炭素鋼の全面腐食の加速因子として支配的なものは、溶存酸素、pH、塩分濃度、水質条件である。想定破損を除外する系統の水質は、補助給水ビット、原子炉補機冷却水サージタンク、ろ過水タンク、空調用冷水膨張タンクである。</p> <p>以上の検討結果より肉厚測定対象系統及び肉厚測定箇所の考え方を表2に示し、また肉厚測定箇所を図1に示す。</p> <p>表2 肉厚測定対象系統及び肉厚測定箇所の考え方</p> <table border="1" data-bbox="1285 560 1856 668"> <thead> <tr> <th>肉厚測定対象系統</th> <th>系統概要</th> <th>肉厚測定箇所</th> </tr> </thead> <tbody> <tr> <td>水消火系</td> <td>内包水はろ過水であり、溶存酸素濃度が高く、定常的な流れがない系統（系統試験時は流れあり）</td> <td>想定破損を除外する範囲において、減肉が想定される箇所（配管エルボ部、ポンプ吐出など）を選定</td> </tr> </tbody> </table>	肉厚測定対象系統	系統概要	肉厚測定箇所	水消火系	内包水はろ過水であり、溶存酸素濃度が高く、定常的な流れがない系統（系統試験時は流れあり）	想定破損を除外する範囲において、減肉が想定される箇所（配管エルボ部、ポンプ吐出など）を選定	<p>【女川】</p> <p>記載表現の相違</p> <p>設計方針の相違</p> <p>プラント設計による系統の相違</p>
肉厚測定対象系統	系統概要	肉厚測定箇所																					
HNCW	内包水は純水であり、防食剤を含む定常的な流れのある系統	想定破損を除外する範囲において、減肉が想定される箇所（配管エルボ部、ポンプ吐出など）を選定																					
BHR																							
LPCS	内包水は復水であり、防食剤を含まず、定常的な流れがない系統（系統試験時は流れあり）。																						
HPCS																							
RCIC																							
肉厚測定対象系統	系統概要	肉厚測定箇所																					
水消火系	内包水はろ過水であり、溶存酸素濃度が高く、定常的な流れがない系統（系統試験時は流れあり）	想定破損を除外する範囲において、減肉が想定される箇所（配管エルボ部、ポンプ吐出など）を選定																					

赤字：設備、運用又は体制の相違（設計方針の相違）
 青字：記載箇所又は記載内容の相違（記載方針の相違）
 緑字：記載表現、設備名称の相違（実質的な相違なし）

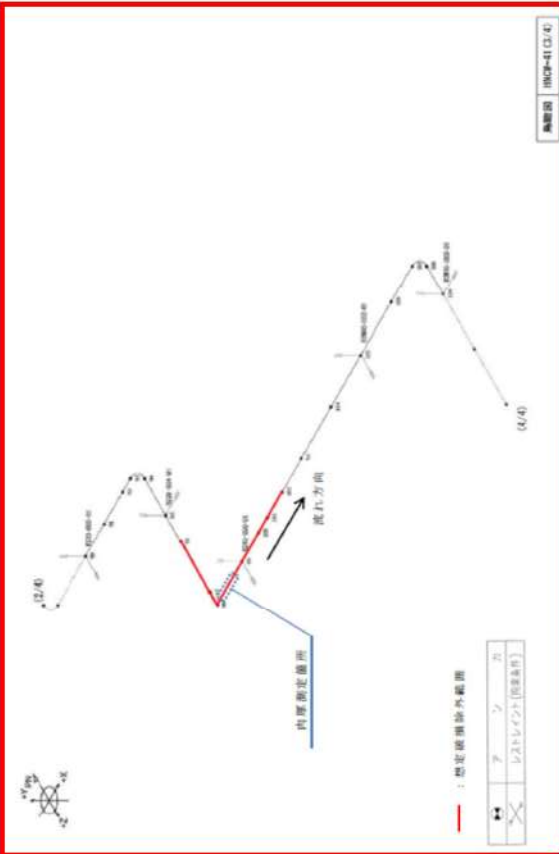
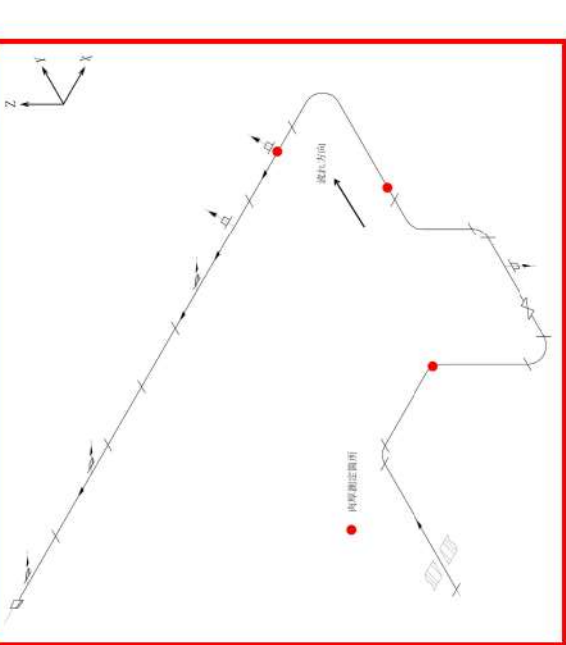
大阪発電所3/4号炉	女川原子力発電所2号炉	泊発電所3号炉	相違理由
	 <p data-bbox="864 1062 1097 1088">図1 肉厚測定箇所（HNCW）</p>	 <p data-bbox="1402 1062 1729 1088">図1 肉厚測定箇所（水消火系）（1/5）</p>	<p data-bbox="1872 178 1930 201">【女川】</p> <p data-bbox="1872 213 1993 236">設計方針の相違</p> <p data-bbox="1872 248 2134 303">プラント設計による対象系統の相違</p> <p data-bbox="1872 1031 1930 1053">【女川】</p> <p data-bbox="1872 1066 1993 1088">記載表現の相違</p> <p data-bbox="1872 1101 2134 1222">女川では別々の系統を載せているので図 1～6 までの図番を記載しているが、泊では同じ系統を載せているので(1/5)～(5/5)とした。</p>

赤字：設備、運用又は体制の相違（設計方針の相違）
 青字：記載箇所又は記載内容の相違（記載方針の相違）
 緑字：記載表現、設備名称の相違（実質的な相違なし）

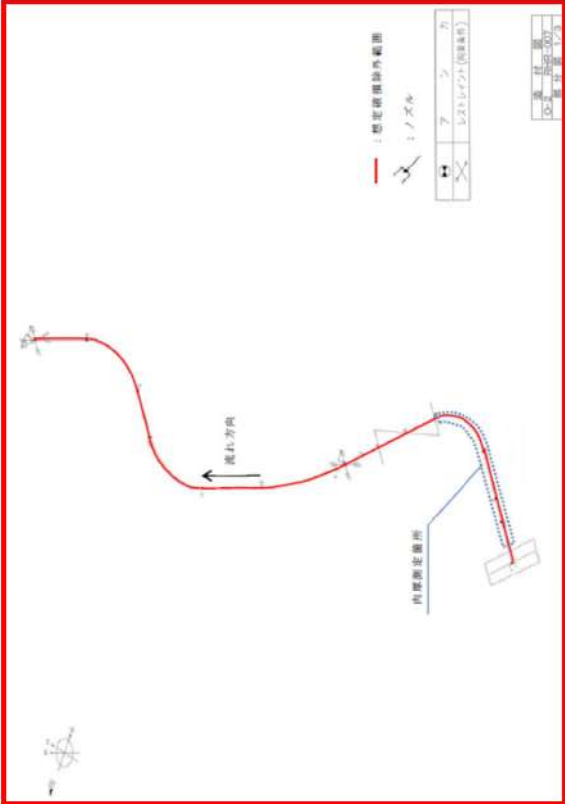
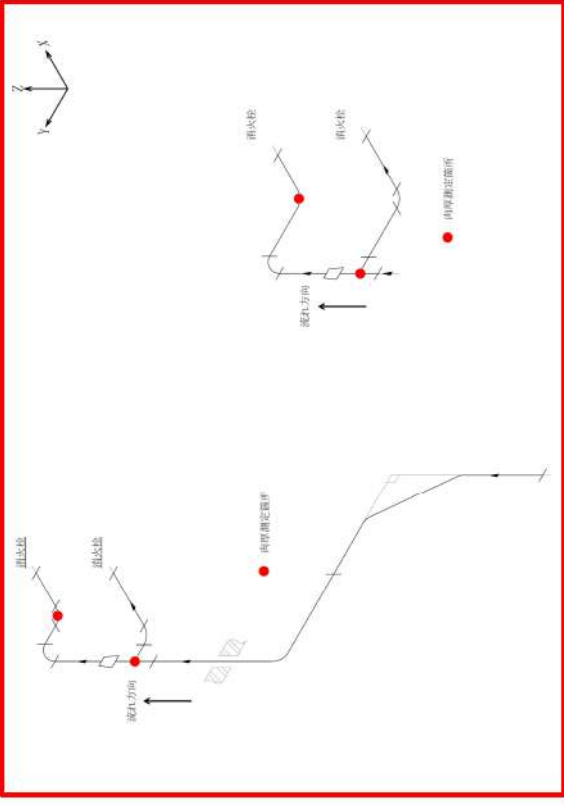
大阪発電所3/4号炉	女川原子力発電所2号炉	泊発電所3号炉	相違理由
	 <p data-bbox="824 1029 1131 1054">図2 肉厚測定箇所 (RHR (A), (B))</p>	 <p data-bbox="1400 1029 1729 1054">図1 肉厚測定箇所 (水消火系) (2/5)</p>	<p data-bbox="1877 178 1937 201">【女川】</p> <p data-bbox="1877 213 1995 236">設計方針の相違</p> <p data-bbox="1877 248 2130 303">プラント設計による対象系統の相違</p> <p data-bbox="1877 1034 1937 1056">【女川】</p> <p data-bbox="1877 1069 1995 1091">記載表現の相違</p> <p data-bbox="1877 1104 2130 1222">女川では別々の系統を載せているので図1～6までの図番を記載しているが、泊では同じ系統を載せているので(1/5)～(5/5)とした。</p>

赤字：設備、運用又は体制の相違 (設計方針の相違)
 青字：記載箇所又は記載内容の相違 (記載方針の相違)
 緑字：記載表現、設備名称の相違 (実質的な相違なし)

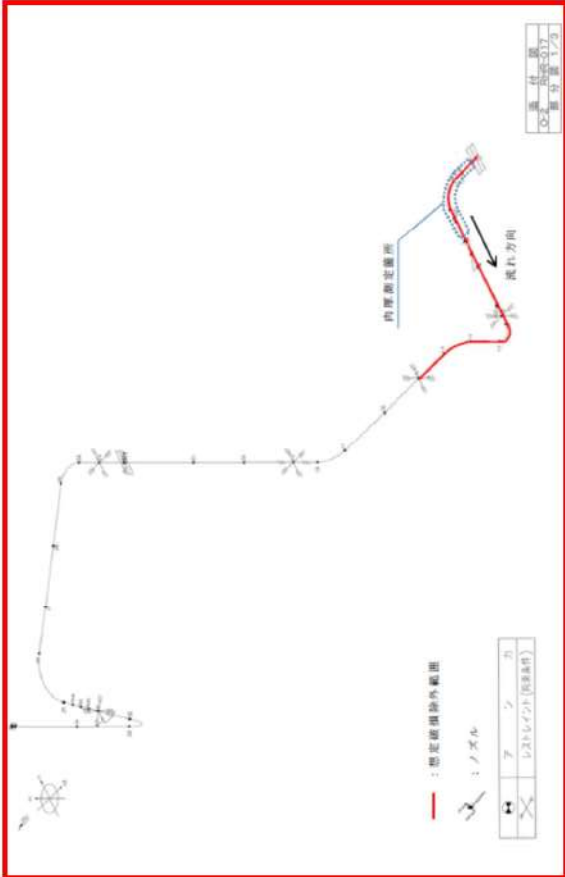
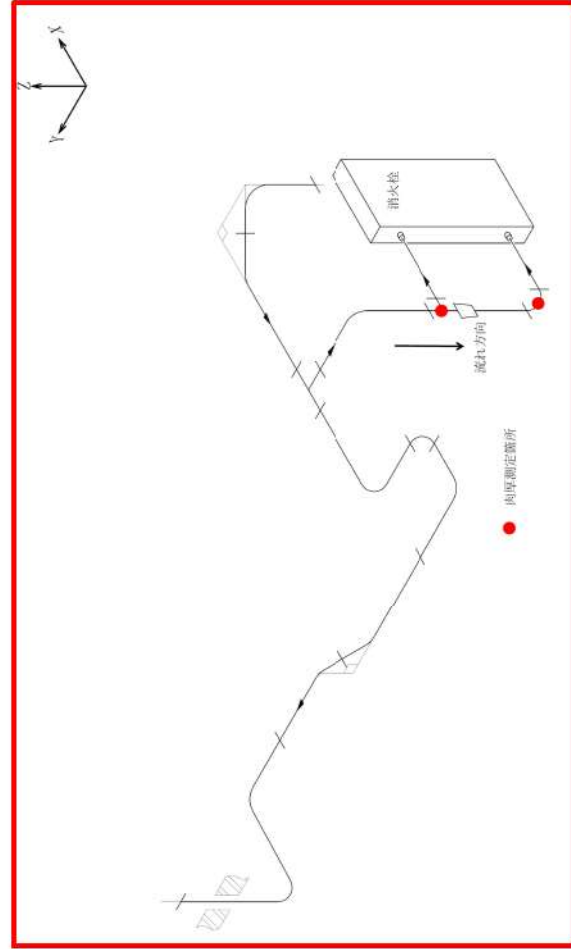
大阪発電所3/4号炉	女川原子力発電所2号炉	泊発電所3号炉	相違理由
	 <p style="text-align: center;">図3 肉厚測定箇所 (RHR(C))</p>	 <p style="text-align: center;">図1 肉厚測定箇所 (水消火系) (3/5)</p>	<p>【女川】 <u>設計方針の相違</u> プラント設計による対象系統の相違</p> <p>【女川】 <u>記載表現の相違</u> 女川では別々の系統を載せているので図1～6までの図番を記載しているが、泊では同じ系統を載せているので(1/5)～(5/5)とした。</p>

赤字：設備、運用又は体制の相違（設計方針の相違）
 青字：記載箇所又は記載内容の相違（記載方針の相違）
 緑字：記載表現、設備名称の相違（実質的な相違なし）

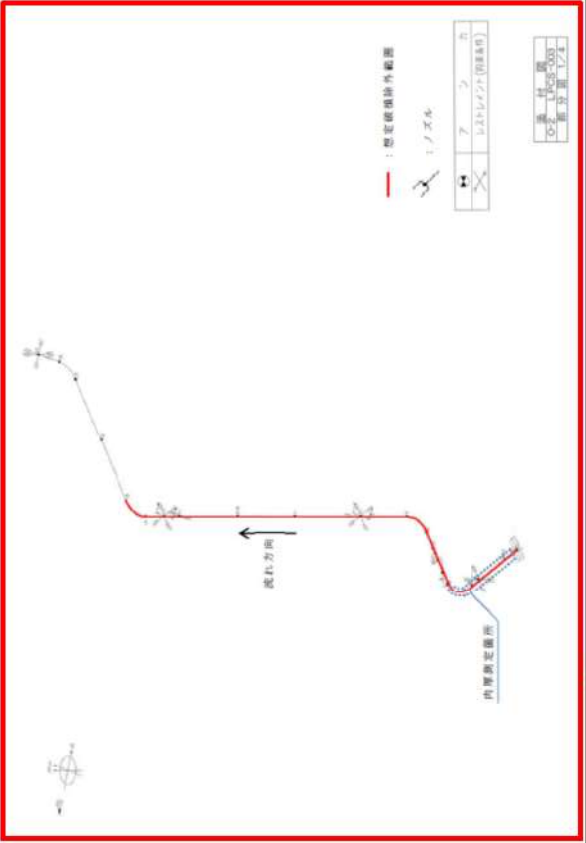
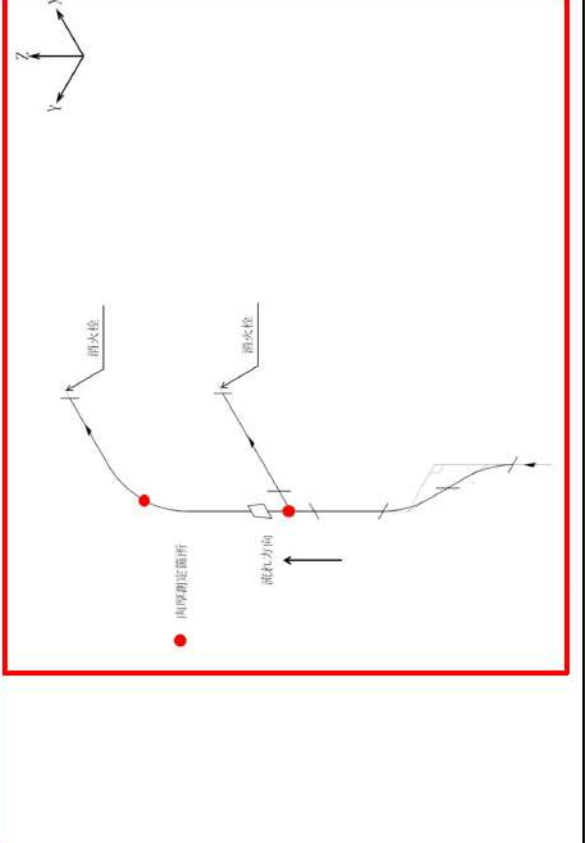
大阪発電所3/4号炉	女川原子力発電所2号炉	泊発電所3号炉	相違理由
	 <p data-bbox="862 1061 1097 1093">図4 肉厚測定箇所 (LPCS)</p>	 <p data-bbox="1400 1061 1736 1093">図1 肉厚測定箇所 (水消火系) (4/5)</p>	<p data-bbox="1874 183 1937 207">【女川】</p> <p data-bbox="1874 215 2136 311">設計方針の相違 プラント設計による対象系統の相違</p> <p data-bbox="1874 1061 1937 1085">【女川】</p> <p data-bbox="1874 1093 2136 1268">記載表現の相違 女川では別々の系統を載せているので図1～6までの図番を記載しているが、泊では同じ系統を載せているので(1/5)～(5/5)とした。</p>

赤字：設備、運用又は体制の相違（設計方針の相違）
 青字：記載箇所又は記載内容の相違（記載方針の相違）
 緑字：記載表現、設備名称の相違（実質的な相違なし）

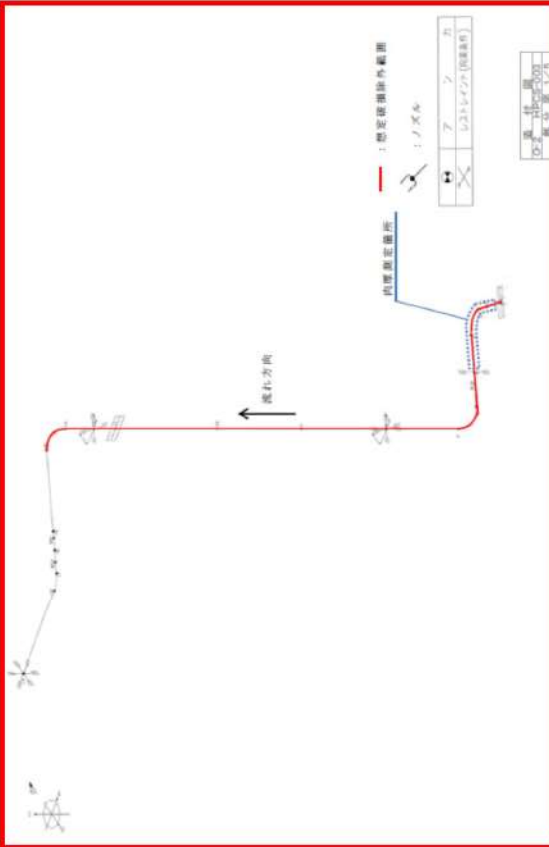
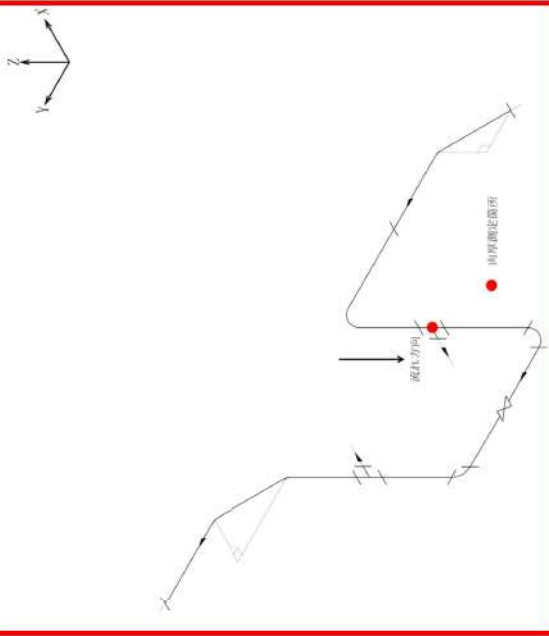
大阪発電所3/4号炉	女川原子力発電所2号炉	泊発電所3号炉	相違理由
	 <p data-bbox="862 1061 1097 1093">図5 肉厚測定箇所 (HPCS)</p>	 <p data-bbox="1400 1061 1736 1093">図1 肉厚測定箇所 (水消火系) (5/5)</p>	<p data-bbox="1877 178 1937 199">【女川】</p> <p data-bbox="1877 215 2004 236">設計方針の相違</p> <p data-bbox="1877 247 2128 300">プラント設計による対象系統の相違</p> <p data-bbox="1877 1061 1937 1082">【女川】</p> <p data-bbox="1877 1098 2004 1118">記載表現の相違</p> <p data-bbox="1877 1133 2128 1257">女川では別々の系統を載せているので図1～6までの図番を記載しているが、泊では同じ系統を載せているので(1/5)～(5/5)とした。</p>

赤字：設備、運用又は体制の相違（設計方針の相違）
 青字：記載箇所又は記載内容の相違（記載方針の相違）
 緑字：記載表現、設備名称の相違（実質的な相違なし）

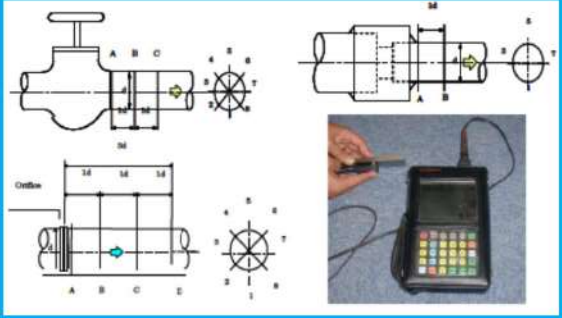
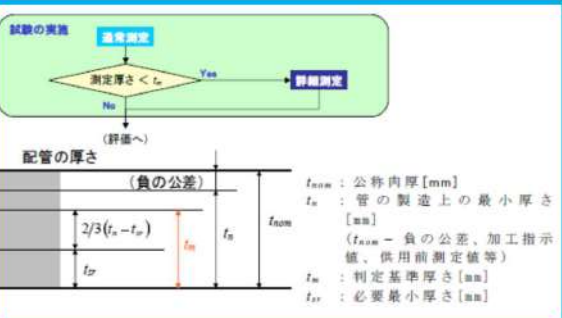
大阪発電所3/4号炉	女川原子力発電所2号炉	泊発電所3号炉	相違理由
<p>2. 肉厚測定</p> <p>(1) 通常測定</p> <p>図6に示すように、定点における肉厚を、UT測定器を用いて、有資格者が測定を実施している。</p>  <p>図6 通常測定の測定部位の例と測定器</p> <p>(2) 詳細測定</p> <p>図7に示すように測定厚さが t_m より小さい場合は、詳細測定（図8）を実施する。</p>  <p>図7 肉厚測定フロー</p>			<p>【大阪】</p> <p>記載方針の相違</p> <p>女川審査実績の反映</p>

赤字：設備、運用又は体制の相違（設計方針の相違）
 青字：記載箇所又は記載内容の相違（記載方針の相違）
 緑字：記載表現、設備名称の相違（実質的な相違なし）

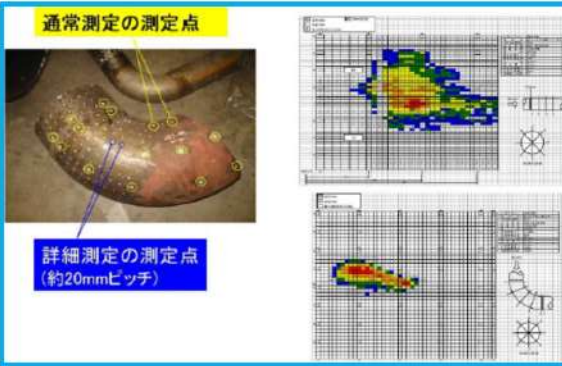
大阪発電所3/4号炉	女川原子力発電所2号炉	泊発電所3号炉	相違理由																																																																																																																																																																																																																																																																																																		
 <p>通常測定の測定点</p> <p>詳細測定の測定点 (約20mmピッチ)</p> <p>図8 詳細測定の方法</p>			<p>【大阪】 記載方針の相違 女川審査実績の反映</p>																																																																																																																																																																																																																																																																																																		
<p>3. 肉厚測定検査の確認結果</p> <p>(1) 高エネルギー配管</p> <p>高エネルギー配管のうち、応力評価を行い破損形状が貫通クラックとしている補助蒸気配管（許容応力は0.8Sa）については、JSME規格の対象外であるが、過去より配管の対策材への取替や、未対策材化部位の定期事業者検査における非破壊検査（肉厚測定）を実施し、減肉量を直接的かつ定期的に把握している。結果を表1に示すとおり、次回点検までの時間は十分ある。</p>	<p>3. 評価結果</p> <p>想定破損除外する箇所の肉厚測定結果を表2に示す。</p>	<p>3. 評価結果</p> <p>想定破損除外する箇所の肉厚測定結果を表3に示す。なお、本評価結果は暫定条件を用いた評価結果であることから、正式条件を用いた評価結果は詳細設計段階で示す。</p> <div style="border: 1px solid black; padding: 5px; margin: 10px auto; width: fit-content;"> <p>追而【地震津波側審査の反映】</p> <p>破線用部分は基準地震動確定後に反映する。</p> </div>	<p>【女川】 記載表現の相違</p>																																																																																																																																																																																																																																																																																																		
<p>表1 補助蒸気配管の定期事業者検査（非破壊検査）実績(例)</p> <table border="1" data-bbox="112 957 672 1149"> <thead> <tr> <th>プラント</th> <th>名称</th> <th>測定箇所</th> <th>口径</th> <th>公称肉厚^{※1}</th> <th>次回点検までの期間^{※2}</th> <th>点検回数</th> </tr> </thead> <tbody> <tr><td>大阪3号炉</td><td>格納容器給気ユニット再熱コイル加熱蒸気管</td><td>直管</td><td>38</td><td>5.5mm</td><td>24.1年</td><td>#11,12,14</td></tr> <tr><td>大阪3号炉</td><td>格納容器給気ユニット再熱コイル加熱蒸気管</td><td>エルボ</td><td>38</td><td>5.5mm</td><td>22.1年</td><td>#11,12,14</td></tr> <tr><td>大阪3号炉</td><td>格納容器給気ユニット再熱コイル加熱蒸気管</td><td>エルボ</td><td>38</td><td>5.5mm</td><td>28.7年</td><td>#11,12,14</td></tr> <tr><td>大阪3号炉</td><td>格納容器給気ユニット再熱コイル加熱蒸気管</td><td>エルボ</td><td>38</td><td>5.5mm</td><td>26.7年</td><td>#11,12,14</td></tr> <tr><td>大阪3号炉</td><td>格納容器給気ユニット再熱コイル加熱蒸気管</td><td>直管</td><td>38</td><td>5.5mm</td><td>27.4年</td><td>#11,12,14</td></tr> <tr><td>大阪4号炉</td><td>格納容器給気ユニット再熱コイル加熱蒸気管</td><td>エルボ</td><td>38</td><td>5.5mm</td><td>25.0年</td><td>#11,14</td></tr> <tr><td>大阪4号炉</td><td>格納容器給気ユニット再熱コイル加熱蒸気管</td><td>エルボ</td><td>38</td><td>5.5mm</td><td>20.0年</td><td>#11,14</td></tr> <tr><td>大阪4号炉</td><td>格納容器給気ユニット再熱コイル加熱蒸気管</td><td>エルボ</td><td>38</td><td>5.5mm</td><td>24.2年</td><td>#11,14</td></tr> <tr><td>大阪4号炉</td><td>格納容器給気ユニット再熱コイル加熱蒸気管</td><td>エルボ</td><td>38</td><td>5.5mm</td><td>22.4年</td><td>#11,14</td></tr> <tr><td>大阪4号炉</td><td>格納容器給気ユニット再熱コイル加熱蒸気管</td><td>エルボ</td><td>38</td><td>5.5mm</td><td>21.0年</td><td>#11,14</td></tr> </tbody> </table> <p>※1 測定結果は5.0～5.9mm ※2 発生応力が0.8Saを上回る最小厚さに至るまでの期間またはJSME S-N61-2006の必要最小厚さtarを下回るまでの期間のいずれか短い期間</p>	プラント	名称	測定箇所	口径	公称肉厚 ^{※1}	次回点検までの期間 ^{※2}	点検回数	大阪3号炉	格納容器給気ユニット再熱コイル加熱蒸気管	直管	38	5.5mm	24.1年	#11,12,14	大阪3号炉	格納容器給気ユニット再熱コイル加熱蒸気管	エルボ	38	5.5mm	22.1年	#11,12,14	大阪3号炉	格納容器給気ユニット再熱コイル加熱蒸気管	エルボ	38	5.5mm	28.7年	#11,12,14	大阪3号炉	格納容器給気ユニット再熱コイル加熱蒸気管	エルボ	38	5.5mm	26.7年	#11,12,14	大阪3号炉	格納容器給気ユニット再熱コイル加熱蒸気管	直管	38	5.5mm	27.4年	#11,12,14	大阪4号炉	格納容器給気ユニット再熱コイル加熱蒸気管	エルボ	38	5.5mm	25.0年	#11,14	大阪4号炉	格納容器給気ユニット再熱コイル加熱蒸気管	エルボ	38	5.5mm	20.0年	#11,14	大阪4号炉	格納容器給気ユニット再熱コイル加熱蒸気管	エルボ	38	5.5mm	24.2年	#11,14	大阪4号炉	格納容器給気ユニット再熱コイル加熱蒸気管	エルボ	38	5.5mm	22.4年	#11,14	大阪4号炉	格納容器給気ユニット再熱コイル加熱蒸気管	エルボ	38	5.5mm	21.0年	#11,14	<p>表2 肉厚測定結果</p> <table border="1" data-bbox="705 957 1265 1228"> <thead> <tr> <th rowspan="2">管理番号 (7/7番号)</th> <th rowspan="2">公称肉厚 (mm)</th> <th rowspan="2">製造上の最小肉厚 (mm)</th> <th rowspan="2">必要最低肉厚 (mm)</th> <th colspan="2">測定値</th> <th colspan="2">減肉率</th> <th rowspan="2">余寿命 (年)</th> <th rowspan="2">結果 **</th> </tr> <tr> <th>低肉厚 (mm)</th> <th>小肉厚 (mm)</th> <th>減肉率 (mm/h)</th> <th>算出方法</th> </tr> </thead> <tbody> <tr><td>HNCW-P41-1</td><td>5.5</td><td>4.81</td><td>2.4</td><td>5.2</td><td>5.2</td><td>1.77×10^{-4}</td><td>*1</td><td>*2</td><td>良</td></tr> <tr><td>RHR-2-1</td><td>11.1</td><td>9.71</td><td>6.34</td><td>11.0</td><td>11.0</td><td>5.90×10^{-7}</td><td>*1</td><td>*2</td><td>良</td></tr> <tr><td>RHR-6-1</td><td>11.1</td><td>9.71</td><td>6.34</td><td>10.9</td><td>10.9</td><td>1.18×10^{-3}</td><td>*1</td><td>*2</td><td>良</td></tr> <tr><td>RHR-6-2</td><td>10.3</td><td>9.01</td><td>5.68</td><td>11.3</td><td>11.3</td><td>-</td><td>-</td><td>-</td><td>良</td></tr> <tr><td>LPCS-2-1</td><td>10.3</td><td>9.01</td><td>5.68</td><td>9.9</td><td>9.9</td><td>2.36×10^{-4}</td><td>*1</td><td>*2</td><td>良</td></tr> <tr><td>HPCS-2-1</td><td>17.4</td><td>15.22</td><td>6.71</td><td>15.5</td><td>15.5</td><td>1.12×10^{-3}</td><td>*1</td><td>89.5</td><td>良</td></tr> <tr><td>HPCS-2-1</td><td>25.4</td><td>22.22</td><td>16.01</td><td>22.2</td><td>22.2</td><td>1.89×10^{-3}</td><td>*1</td><td>37.4</td><td>良</td></tr> <tr><td>RCIC-2-1</td><td>13.5</td><td>11.81</td><td>6.25</td><td>12.2</td><td>12.2</td><td>7.67×10^{-4}</td><td>*1</td><td>88.6</td><td>良</td></tr> </tbody> </table> <p>※1 公称肉厚データと今回測定データにより算出する方法。 ※2 残時間100万時間以上 ※3 判定基準：配管の測定最小肉厚が必要以上確保されていること及び余寿命が1サイクル（1.2年）以上であること。（出典：「発電用原子力設備規格沸騰水型原子力発電所配管減肉管理に関する技術規格（2006年版）JSME S-NH1-2006（以下「JSME規格」）の「CA-5000評価」による）</p>	管理番号 (7/7番号)	公称肉厚 (mm)	製造上の最小肉厚 (mm)	必要最低肉厚 (mm)	測定値		減肉率		余寿命 (年)	結果 **	低肉厚 (mm)	小肉厚 (mm)	減肉率 (mm/h)	算出方法	HNCW-P41-1	5.5	4.81	2.4	5.2	5.2	1.77×10^{-4}	*1	*2	良	RHR-2-1	11.1	9.71	6.34	11.0	11.0	5.90×10^{-7}	*1	*2	良	RHR-6-1	11.1	9.71	6.34	10.9	10.9	1.18×10^{-3}	*1	*2	良	RHR-6-2	10.3	9.01	5.68	11.3	11.3	-	-	-	良	LPCS-2-1	10.3	9.01	5.68	9.9	9.9	2.36×10^{-4}	*1	*2	良	HPCS-2-1	17.4	15.22	6.71	15.5	15.5	1.12×10^{-3}	*1	89.5	良	HPCS-2-1	25.4	22.22	16.01	22.2	22.2	1.89×10^{-3}	*1	37.4	良	RCIC-2-1	13.5	11.81	6.25	12.2	12.2	7.67×10^{-4}	*1	88.6	良	<p>表3 肉厚測定結果（水消火系）</p> <table border="1" data-bbox="1299 957 1848 1340"> <thead> <tr> <th rowspan="2">管理番号</th> <th rowspan="2">公称肉厚 (mm)</th> <th rowspan="2">製造上の最小肉厚 (mm)</th> <th rowspan="2">必要最低肉厚 (mm)</th> <th rowspan="2">測定最小肉厚 (mm)</th> <th colspan="2">減肉率</th> <th rowspan="2">余寿命 (年)</th> <th rowspan="2">結果</th> </tr> <tr> <th>減肉率 (mm/h)</th> <th>算出方法</th> </tr> </thead> <tbody> <tr><td>1</td><td></td><td></td><td></td><td></td><td></td><td></td><td></td><td></td></tr> <tr><td>2</td><td></td><td></td><td></td><td></td><td></td><td></td><td></td><td></td></tr> <tr><td>3</td><td></td><td></td><td></td><td></td><td></td><td></td><td></td><td></td></tr> <tr><td>4</td><td></td><td></td><td></td><td></td><td></td><td></td><td></td><td></td></tr> <tr><td>5</td><td></td><td></td><td></td><td></td><td></td><td></td><td></td><td></td></tr> <tr><td>6</td><td></td><td></td><td></td><td></td><td></td><td></td><td></td><td></td></tr> <tr><td>7</td><td></td><td></td><td></td><td></td><td></td><td></td><td></td><td></td></tr> <tr><td>8</td><td></td><td></td><td></td><td></td><td></td><td></td><td></td><td></td></tr> <tr><td>9</td><td></td><td></td><td></td><td></td><td></td><td></td><td></td><td></td></tr> <tr><td>10</td><td></td><td></td><td></td><td></td><td></td><td></td><td></td><td></td></tr> <tr><td>11</td><td></td><td></td><td></td><td></td><td></td><td></td><td></td><td></td></tr> <tr><td>12</td><td></td><td></td><td></td><td></td><td></td><td></td><td></td><td></td></tr> </tbody> </table>	管理番号	公称肉厚 (mm)	製造上の最小肉厚 (mm)	必要最低肉厚 (mm)	測定最小肉厚 (mm)	減肉率		余寿命 (年)	結果	減肉率 (mm/h)	算出方法	1									2									3									4									5									6									7									8									9									10									11									12									<p>【女川・大阪】 記載方針の相違 配管の余寿命評価に必要な対象システムの応力評価結果は詳細設計段階で正式な評価結果を示す方針としているため、肉厚測定結果についても詳細設計段階で提示することを記載している。 記載表現の相違</p>
プラント	名称	測定箇所	口径	公称肉厚 ^{※1}	次回点検までの期間 ^{※2}	点検回数																																																																																																																																																																																																																																																																																															
大阪3号炉	格納容器給気ユニット再熱コイル加熱蒸気管	直管	38	5.5mm	24.1年	#11,12,14																																																																																																																																																																																																																																																																																															
大阪3号炉	格納容器給気ユニット再熱コイル加熱蒸気管	エルボ	38	5.5mm	22.1年	#11,12,14																																																																																																																																																																																																																																																																																															
大阪3号炉	格納容器給気ユニット再熱コイル加熱蒸気管	エルボ	38	5.5mm	28.7年	#11,12,14																																																																																																																																																																																																																																																																																															
大阪3号炉	格納容器給気ユニット再熱コイル加熱蒸気管	エルボ	38	5.5mm	26.7年	#11,12,14																																																																																																																																																																																																																																																																																															
大阪3号炉	格納容器給気ユニット再熱コイル加熱蒸気管	直管	38	5.5mm	27.4年	#11,12,14																																																																																																																																																																																																																																																																																															
大阪4号炉	格納容器給気ユニット再熱コイル加熱蒸気管	エルボ	38	5.5mm	25.0年	#11,14																																																																																																																																																																																																																																																																																															
大阪4号炉	格納容器給気ユニット再熱コイル加熱蒸気管	エルボ	38	5.5mm	20.0年	#11,14																																																																																																																																																																																																																																																																																															
大阪4号炉	格納容器給気ユニット再熱コイル加熱蒸気管	エルボ	38	5.5mm	24.2年	#11,14																																																																																																																																																																																																																																																																																															
大阪4号炉	格納容器給気ユニット再熱コイル加熱蒸気管	エルボ	38	5.5mm	22.4年	#11,14																																																																																																																																																																																																																																																																																															
大阪4号炉	格納容器給気ユニット再熱コイル加熱蒸気管	エルボ	38	5.5mm	21.0年	#11,14																																																																																																																																																																																																																																																																																															
管理番号 (7/7番号)	公称肉厚 (mm)	製造上の最小肉厚 (mm)	必要最低肉厚 (mm)	測定値		減肉率		余寿命 (年)	結果 **																																																																																																																																																																																																																																																																																												
				低肉厚 (mm)	小肉厚 (mm)	減肉率 (mm/h)	算出方法																																																																																																																																																																																																																																																																																														
HNCW-P41-1	5.5	4.81	2.4	5.2	5.2	1.77×10^{-4}	*1	*2	良																																																																																																																																																																																																																																																																																												
RHR-2-1	11.1	9.71	6.34	11.0	11.0	5.90×10^{-7}	*1	*2	良																																																																																																																																																																																																																																																																																												
RHR-6-1	11.1	9.71	6.34	10.9	10.9	1.18×10^{-3}	*1	*2	良																																																																																																																																																																																																																																																																																												
RHR-6-2	10.3	9.01	5.68	11.3	11.3	-	-	-	良																																																																																																																																																																																																																																																																																												
LPCS-2-1	10.3	9.01	5.68	9.9	9.9	2.36×10^{-4}	*1	*2	良																																																																																																																																																																																																																																																																																												
HPCS-2-1	17.4	15.22	6.71	15.5	15.5	1.12×10^{-3}	*1	89.5	良																																																																																																																																																																																																																																																																																												
HPCS-2-1	25.4	22.22	16.01	22.2	22.2	1.89×10^{-3}	*1	37.4	良																																																																																																																																																																																																																																																																																												
RCIC-2-1	13.5	11.81	6.25	12.2	12.2	7.67×10^{-4}	*1	88.6	良																																																																																																																																																																																																																																																																																												
管理番号	公称肉厚 (mm)	製造上の最小肉厚 (mm)	必要最低肉厚 (mm)	測定最小肉厚 (mm)	減肉率		余寿命 (年)	結果																																																																																																																																																																																																																																																																																													
					減肉率 (mm/h)	算出方法																																																																																																																																																																																																																																																																																															
1																																																																																																																																																																																																																																																																																																					
2																																																																																																																																																																																																																																																																																																					
3																																																																																																																																																																																																																																																																																																					
4																																																																																																																																																																																																																																																																																																					
5																																																																																																																																																																																																																																																																																																					
6																																																																																																																																																																																																																																																																																																					
7																																																																																																																																																																																																																																																																																																					
8																																																																																																																																																																																																																																																																																																					
9																																																																																																																																																																																																																																																																																																					
10																																																																																																																																																																																																																																																																																																					
11																																																																																																																																																																																																																																																																																																					
12																																																																																																																																																																																																																																																																																																					

赤字：設備、運用又は体制の相違（設計方針の相違）
 青字：記載箇所又は記載内容の相違（記載方針の相違）
 緑字：記載表現、設備名称の相違（実質的な相違なし）

第9条 溢水による損傷の防止等（別添1添付資料15）

大阪発電所3/4号炉	女川原子力発電所2号炉	泊発電所3号炉	相違理由																																																																																																																														
<p>(2)低エネルギー配管</p> <p>低エネルギー配管（破損なし：応力の上限は0.4Sa）のうち、炭素鋼配管は内部流体による全面腐食の可能性が考えられるが、低温域においては、酸素飽和の条件においてもその腐食量は軽微である。また、補助給水系統他について非破壊検査による肉厚測定を実施しており、腐食量を直接的に把握している。結果を表2、3に示すとおり、次回点検までの時間は十分ある。</p> <p>表2 大阪3号炉 低エネルギー配管の非破壊検査実績（例）</p> <table border="1" data-bbox="114 491 683 671"> <thead> <tr> <th>プラント</th> <th>名称</th> <th>測定箇所</th> <th>口径</th> <th>公称肉厚^{※1}</th> <th>次回定検までの期間^{※2}</th> <th>定検回次</th> </tr> </thead> <tbody> <tr><td>大阪3号炉</td><td>補助給水配管ポンプ出口配管</td><td>直管</td><td>3B</td><td>7.6mm</td><td>50.7年</td><td>#16</td></tr> <tr><td>大阪3号炉</td><td>補助給水流量オリフィス下流配管</td><td>直管</td><td>3B</td><td>7.6mm</td><td>50.7年</td><td>#16</td></tr> <tr><td>大阪3号炉</td><td>消火水系</td><td>直管</td><td>3B</td><td>7.1mm</td><td>63.1年</td><td>#16</td></tr> <tr><td>大阪3号炉</td><td>消火水系</td><td>直管</td><td>3B</td><td>5.5mm</td><td>80.3年</td><td>#16</td></tr> <tr><td>大阪3号炉</td><td>冷水系</td><td>直管</td><td>6B</td><td>7.1mm</td><td>100年以上</td><td>#16</td></tr> <tr><td>大阪3号炉</td><td>冷水系</td><td>エルボ</td><td>4B</td><td>6.0mm</td><td>100年以上</td><td>#16</td></tr> <tr><td>大阪3号炉</td><td>原子炉補機冷却系</td><td>直管</td><td>3B</td><td>5.5mm</td><td>100年以上</td><td>#16</td></tr> <tr><td>大阪3号炉</td><td>原子炉補機冷却系</td><td>エルボ</td><td>3B</td><td>5.5mm</td><td>100年以上</td><td>#16</td></tr> </tbody> </table> <p>※1 測定結果は5.1～7.2mm ※2 発生応力が0.4Saを上回る最小厚さに至るまでの期間またはJSME S NG1-2006の必要最小厚さtarを下回るまでの期間のいずれか短い期間</p> <p>表3 大阪4号炉 低エネルギー配管の非破壊検査実績（例）</p> <table border="1" data-bbox="114 871 683 1051"> <thead> <tr> <th>プラント</th> <th>名称</th> <th>測定箇所</th> <th>口径</th> <th>公称肉厚^{※1}</th> <th>次回定検までの期間^{※2}</th> <th>定検回次</th> </tr> </thead> <tbody> <tr><td>大阪4号炉</td><td>補助給水配管ポンプ出口配管</td><td>直管</td><td>3B</td><td>7.6mm</td><td>38.0年</td><td>#15</td></tr> <tr><td>大阪4号炉</td><td>補助給水流量オリフィス下流配管</td><td>直管</td><td>3B</td><td>7.6mm</td><td>74.2年</td><td>#15</td></tr> <tr><td>大阪4号炉</td><td>消火水系</td><td>直管</td><td>3B</td><td>5.5mm</td><td>80.3年</td><td>#15</td></tr> <tr><td>大阪4号炉</td><td>消火水系</td><td>直管</td><td>3B</td><td>5.5mm</td><td>88.7年</td><td>#15</td></tr> <tr><td>大阪4号炉</td><td>冷水系</td><td>直管</td><td>6B</td><td>7.1mm</td><td>77.0年</td><td>#15</td></tr> <tr><td>大阪4号炉</td><td>冷水系</td><td>エルボ</td><td>4B</td><td>7.1mm</td><td>100年以上</td><td>#15</td></tr> <tr><td>大阪4号炉</td><td>原子炉補機冷却系</td><td>直管</td><td>3B</td><td>5.5mm</td><td>100年以上</td><td>#15</td></tr> <tr><td>大阪4号炉</td><td>原子炉補機冷却系</td><td>エルボ</td><td>3B</td><td>5.5mm</td><td>100年以上</td><td>#15</td></tr> </tbody> </table> <p>※3 測定結果は5.1～7.3mm ※4 発生応力が0.4Saを上回る最小厚さに至るまでの期間またはJSME S NG1-2006の必要最小厚さtarを下回るまでの期間のいずれか短い期間</p>	プラント	名称	測定箇所	口径	公称肉厚 ^{※1}	次回定検までの期間 ^{※2}	定検回次	大阪3号炉	補助給水配管ポンプ出口配管	直管	3B	7.6mm	50.7年	#16	大阪3号炉	補助給水流量オリフィス下流配管	直管	3B	7.6mm	50.7年	#16	大阪3号炉	消火水系	直管	3B	7.1mm	63.1年	#16	大阪3号炉	消火水系	直管	3B	5.5mm	80.3年	#16	大阪3号炉	冷水系	直管	6B	7.1mm	100年以上	#16	大阪3号炉	冷水系	エルボ	4B	6.0mm	100年以上	#16	大阪3号炉	原子炉補機冷却系	直管	3B	5.5mm	100年以上	#16	大阪3号炉	原子炉補機冷却系	エルボ	3B	5.5mm	100年以上	#16	プラント	名称	測定箇所	口径	公称肉厚 ^{※1}	次回定検までの期間 ^{※2}	定検回次	大阪4号炉	補助給水配管ポンプ出口配管	直管	3B	7.6mm	38.0年	#15	大阪4号炉	補助給水流量オリフィス下流配管	直管	3B	7.6mm	74.2年	#15	大阪4号炉	消火水系	直管	3B	5.5mm	80.3年	#15	大阪4号炉	消火水系	直管	3B	5.5mm	88.7年	#15	大阪4号炉	冷水系	直管	6B	7.1mm	77.0年	#15	大阪4号炉	冷水系	エルボ	4B	7.1mm	100年以上	#15	大阪4号炉	原子炉補機冷却系	直管	3B	5.5mm	100年以上	#15	大阪4号炉	原子炉補機冷却系	エルボ	3B	5.5mm	100年以上	#15			<p>【大阪】</p> <p>記載方針の相違</p> <p>女川審査実績の反映</p>
プラント	名称	測定箇所	口径	公称肉厚 ^{※1}	次回定検までの期間 ^{※2}	定検回次																																																																																																																											
大阪3号炉	補助給水配管ポンプ出口配管	直管	3B	7.6mm	50.7年	#16																																																																																																																											
大阪3号炉	補助給水流量オリフィス下流配管	直管	3B	7.6mm	50.7年	#16																																																																																																																											
大阪3号炉	消火水系	直管	3B	7.1mm	63.1年	#16																																																																																																																											
大阪3号炉	消火水系	直管	3B	5.5mm	80.3年	#16																																																																																																																											
大阪3号炉	冷水系	直管	6B	7.1mm	100年以上	#16																																																																																																																											
大阪3号炉	冷水系	エルボ	4B	6.0mm	100年以上	#16																																																																																																																											
大阪3号炉	原子炉補機冷却系	直管	3B	5.5mm	100年以上	#16																																																																																																																											
大阪3号炉	原子炉補機冷却系	エルボ	3B	5.5mm	100年以上	#16																																																																																																																											
プラント	名称	測定箇所	口径	公称肉厚 ^{※1}	次回定検までの期間 ^{※2}	定検回次																																																																																																																											
大阪4号炉	補助給水配管ポンプ出口配管	直管	3B	7.6mm	38.0年	#15																																																																																																																											
大阪4号炉	補助給水流量オリフィス下流配管	直管	3B	7.6mm	74.2年	#15																																																																																																																											
大阪4号炉	消火水系	直管	3B	5.5mm	80.3年	#15																																																																																																																											
大阪4号炉	消火水系	直管	3B	5.5mm	88.7年	#15																																																																																																																											
大阪4号炉	冷水系	直管	6B	7.1mm	77.0年	#15																																																																																																																											
大阪4号炉	冷水系	エルボ	4B	7.1mm	100年以上	#15																																																																																																																											
大阪4号炉	原子炉補機冷却系	直管	3B	5.5mm	100年以上	#15																																																																																																																											
大阪4号炉	原子炉補機冷却系	エルボ	3B	5.5mm	100年以上	#15																																																																																																																											

赤字：設備、運用又は体制の相違（設計方針の相違）
 青字：記載箇所又は記載内容の相違（記載方針の相違）
 緑字：記載表現、設備名称の相違（実質的な相違なし）

大阪発電所3/4号炉	女川原子力発電所2号炉	泊発電所3号炉	相違理由
	<p style="text-align: right;">添付資料 17</p> <p>系統別溢水量算出結果</p> <p>各建屋・エリアの系統別溢水量算出結果を表1～9に示す。</p>	<p style="text-align: right;">添付資料 16</p> <p>系統別溢水量算出結果</p> <p>各建屋の系統別溢水量算出結果を表1～11に示す。</p>	<p>【女川】</p> <p>記載表現の相違</p> <p>記載方針の相違</p> <p>女川は「海水ポンプ室及び復水貯蔵タンクエリア」、「軽油タンクエリア」があり、泊ではエリアとして記載している箇所はないため左記の記載とする。</p>

赤字：設備、運用又は体制の相違（設計方針の相違）
 青字：記載箇所又は記載内容の相違（記載方針の相違）
 緑字：記載表現、設備名称の相違（実質的な相違なし）

大阪発電所3/4号炉		女川原子力発電所2号炉					泊発電所3号炉					相違理由
表1 漏えい停止までの時間の設定及び漏えい量（化学体積制御系） その1		表1 原子炉建屋原子炉棟及び付属棟 系統別溢水量					表1 原子炉建屋 系統別溢水量					【女川】 設計方針の相違 ・プラント設計による建屋名称、対象系統、保有水量、漏えい量、溢水量、隔離手段の相違。 ・女川では、「 <u>手動隔離を期待</u> （他系統との接続補給ラインあり）」としているが、泊では、他系統との接続補給ラインがなくても、 <u>手動隔離に期待した隔離時間</u> にて系統漏えい量を算出していることから、「 <u>手動隔離を期待</u> 」のみとした。 ・また、中央制御室での手動隔離に期待している系統について、「○（中央制御室内での手動隔離）」と記載した。 【大阪】 記載方針の相違 大阪では系統の破断範囲ごとに隔離までの漏えい量を算出しているが、本資料内では、女川と同様の形でまとめる。別途、補足説明資料2「保有水量・系統別溢水量算出要領」にて、大阪と同様に算出した結果を記載する。
<p>①異常の検知 <システム検知> 配管破損により、破損側封水注入流量が増加するため、健全側封水注入流量が低下し、封水注入流量低警報が発信（定格流量 1.5m³/h に対して低警報 1.5m³/h であるため、速やかに警報が発信する） また、封水注入合計流量の増加により、封水注入ファイラタ差圧高警報が発信</p> <p>②事象の判断及び漏えい箇所の特定 以下のパラメータから封水注入流量計上流配管からの漏えいと判断 10分 封水戻り流量、原子炉周辺建屋サンプ水位、RMS 測定値(R-21A/B)、封水注入ファイラタ差圧、漏水注意等</p> <p>③漏えい箇所の隔離等 中央制御室において、封水注入ライン流量制御弁を遠隔手動閉止 1分</p> <p>合計時間 (①+②+③) 11分</p> <p>漏えい量 漏えい量21.5m³ 封水注入流量 7.2m³/h (1 ループ当たり 1.5m³/h) 11分/60分×7.2m³/h = 1.4m³ 配管保有水量 20.4m³ 1.4m³+20.4m³=21.8m³</p>	<p>対象系統</p> <p>系統保有水量 (m³) W2</p> <p>系統漏えい量 (m³) W1</p> <p>系統溢水量 (m³) W (=W1+W2)</p> <p>手動隔離を期待 (他系統との接続補給ラインあり)</p>	<p>対象系統</p> <p>系統保有水量 (m³) W2</p> <p>系統漏えい量 (m³) W1</p> <p>系統溢水量 (m³) W (=W1+W2)</p> <p>手動隔離を期待</p>	<p>【女川】 設計方針の相違 ・プラント設計による建屋名称、対象系統、保有水量、漏えい量、溢水量、隔離手段の相違。 ・女川では、「<u>手動隔離を期待</u>（他系統との接続補給ラインあり）」としているが、泊では、他系統との接続補給ラインがなくても、<u>手動隔離に期待した隔離時間</u>にて系統漏えい量を算出していることから、「<u>手動隔離を期待</u>」のみとした。 ・また、中央制御室での手動隔離に期待している系統について、「○（中央制御室内での手動隔離）」と記載した。 【大阪】 記載方針の相違 大阪では系統の破断範囲ごとに隔離までの漏えい量を算出しているが、本資料内では、女川と同様の形でまとめる。別途、補足説明資料2「保有水量・系統別溢水量算出要領」にて、大阪と同様に算出した結果を記載する。</p>									
<p>想定範囲 封水注入配管（貫通部～流量計）</p> <p>封水注入配管（流量計～封水注入ライン流量制御弁）</p>	<p>R21 FDW 44 432 476 - (自動隔離)</p> <p>C12 CBD 22 31 53 ○</p> <p>C41 SLC 44 21 65 ○</p> <p>E11 BHR 46 191 237 ○</p> <p>E21 LPCS 11 265 266 ○</p> <p>E22 HPSC 44 351 395 ○</p> <p>E51 RCIC 11 179 190 ○</p> <p>G31 CUW 36 103 139 - (自動隔離)</p> <p>G41 FFC 90 70 160 ○</p> <p>K11 RD 55 0 55 -</p> <p>K12 LCW 33 0 33 -</p> <p>K13 HCW 33 0 33 -</p> <p>P11 MURP 11 30 41 ○</p> <p>P13 MURC 28 120 148 ○</p> <p>P14 FW 11 54 65 ○</p> <p>P15 FFMW 12 23 35 ○</p> <p>P24 HNCW 55 8 63 ○</p> <p>P25 HECW 33 8 41 ○</p> <p>P42 RCW 233 32 265 ○</p> <p>P45 RSW 176 182 358 ○</p> <p>P47 HPCW 22 32 54 ○</p> <p>P48 HPSW 22 64 86 ○</p> <p>P64 HWH 22 32 54 ○</p> <p>U43 FP 180 27 207 ○</p> <p>U63 MSC 33 0 33 -</p> <p>R43, R44 DGCW 22 9 31 ○</p> <p>R43, R44 DGLD 22 0 22 -</p> <p>R43, R44 DGD0 11 12 23 ○</p>	<p>化学体積制御系（充てん配管） 5.6 32 37.6 ○（中央制御室内での手動隔離）</p> <p>化学体積制御系（抽出配管） 11.9 8.6 20.5 ○（中央制御室内での手動隔離）</p> <p>主蒸気系（主蒸気管内） 81 393.1 474.1 ○（中央制御室内での手動隔離）</p> <p>主給水系 補助給水系（主蒸気管内） 15 627.3 642.3 ○（中央制御室内での手動隔離）</p> <p>蒸気発生器ブローダウン系（主蒸気管内） 81 216.8 297.8 ○（中央制御室内での手動隔離）</p> <p>補助蒸気系 1 2.7 3.7 -（自動隔離）</p>										

赤字：設備、運用又は体制の相違（設計方針の相違）
 青字：記載箇所又は記載内容の相違（記載方針の相違）
 緑字：記載表現、設備名称の相違（実質的な相違なし）

第9条 溢水による損傷の防止等（別添1添付資料16）

大阪発電所3/4号炉		女川原子力発電所2号炉					泊発電所3号炉					相違理由
表2 漏えい停止までの時間の設定及び漏えい量（化学体積制御系）その2		表2 制御建屋 系統別溢水量					表2 原子炉補助建屋 系統別溢水量					<p>【女川】</p> <p><u>設計方針の相違</u></p> <p>・プラント設計による建屋名称、対象系統、保有水量、漏えい量、溢水量、隔離手段の相違。</p> <p>・女川では、「<u>手動隔離を期待</u>（他系統との接続補給ラインあり）」としているが、泊では、他系統との接続補給ラインがなくても、手動隔離に期待した隔離時間にて系統漏えい量を算出していることから、「手動隔離を期待」のみとした。</p> <p>・また、中央制御室での手動隔離に期待している系統について、「○（中央制御室内での手動隔離）」と記載した。</p> <p>【大阪】</p> <p><u>記載方針の相違</u></p> <p>大阪では系統の破断範囲ごとに隔離までの漏えい量を算出しているが、本資料内では、女川と同様の形でまとめる。別途、補足説明資料2「保有水量・系統別溢水量算出要領」にて、大阪と同様に算出した結果を記載する。</p>
<p>① 漏えい量</p> <p>漏えい量 31.5m³</p> <p>充てんポンプのランナウト流量 56.8m³/h 12分/60分×56.8m³/h = 11.4m³ 配管保有水量 20.4m³ 11.4m³+20.4m³=31.8m³</p>	<p>合計時間 (①+②+③)</p> <p>13分</p>	<p>② 漏えい箇所の隔離等により漏えい停止</p> <p>中央制御室において、充てんポンプ流量制御弁を遠隔手動停止1分 又は、充てんポンプ1台を遠隔手動停止2分 （操作1分、停止1分、合わせて2分）</p>	<p>② 事故の相違及び漏えい箇所の特定</p> <p>以下のボアメータから充てん配管からの漏えいと同時10分 WCT 水位、充てん流量、原子炉周辺建屋サンプリング水位、RCS 測定値(0-21A)相当</p>	<p>① 異常の検知</p> <p><システム検知> 配管破損により、充てん流量が上昇し、充てん流量高警報が発信 0.5分 （通常の充てん流量 25m³/h に対して高警報 28m³/h であるため、速やかに警報が発信する）</p> <p><システム検知> 配管破損により、充てん流量が低下し、充てん流量低警報が発信 0.5分 （通常の充てん流量 25m³/h に対して低警報 8m³/h であるため、速やかに警報が発信する）</p> <p><サンプリング検知> 配管破損により床下ドレン系を經由して原子炉周辺建屋サンプリングタンク(10m³)に流入 サンプリング水位(20%±1.5%)からポンプ起動水位(90%±1.5%)まで水位が上昇し、その後ポンプによる排水を伴ってサンプリング水位高警報水位(95%±1.5%)まで水位が上昇し、サンプリング水位高警報が発信 10m³×(91.5%-15.5%)/100%+13.6m³/h×60分/h+10m³×(96.5%-68.5%)/100%+(13.6m³/h-11.4m³/h)×60分/h=54.1=55分</p>	<p>対象系統</p> <p>系統保有水量 (m³) W2</p> <p>系統漏えい量 (m³) W1</p> <p>系統溢水量 (m³) W(W1+W2)</p> <p>手動隔離を期待（他系統との接続補給ラインあり）</p>	<p>P11 MWP 11 30 41 ○</p> <p>P24 HXCW 22 8 30 ○</p> <p>P25 HECW 33 8 41 ○</p> <p>P62 HS/HSCF 11 0 11 -</p> <p>P64 HWH 22 32 54 ○</p> <p>U43 FP 180 27 207 ○</p> <p>U63 MSC 22 0 22 -</p> <p>- 所内用水 55 13 68 ○</p>	<p>対象系統</p> <p>系統保有水量 (m³) W2</p> <p>系統漏えい量 (m³) W1</p> <p>系統溢水量 (m³) W(W1+W2)</p> <p>手動隔離を期待</p>	<p>化学体積制御系（充てん配管） 5.6 32 37.6 ○（中央制御室内での手動隔離）</p> <p>化学体積制御系（抽出配管） 11.9 8.6 20.5 ○（中央制御室内での手動隔離）</p> <p>補助蒸気系 1 2.7 3.7 -（自動隔離）</p>				

赤字：設備、運用又は体制の相違（設計方針の相違）
 青字：記載箇所又は記載内容の相違（記載方針の相違）
 緑字：記載表現、設備名称の相違（実質的な相違なし）

大阪発電所3/4号炉		女川原子力発電所2号炉		泊発電所3号炉		相違理由			
表3 漏えい停止までの時間の設定及び漏えい量（化学体積制御系）その3		表3 海水ポンプ室及び復水貯蔵タンクエリア 系統別溢水量		表3 循環水ポンプ建屋 系統別溢水量		【女川】 設計方針の相違 ・プラント設計による建屋名称、対象系統、保有水量、漏えい量、溢水量、隔離手段の相違。 ・女川では、「手動隔離を期待（他系統との接続補給ラインあり）」としているが、泊では、他系統との接続補給ラインがなくても、手動隔離に期待した隔離時間にて系統漏えい量を算出していることから、「手動隔離を期待」のみとした。			
想定範囲	①異常の検知 ＜システム検知＞ 配管破損によりVCT(11.3m)の保有水が減少しVCT水位が低下する。VCT水位高警報(55%±1.5%)から原子炉補給開始水位(24%±1.5%)まで水位が低下し原子炉補給水開始音が受信 11.3m×(56.5%-22.5%)/100%÷32.0m ³ /h×60分=7.2分	②事象の判断及び漏えい箇所の特定 以下のパラメータからの漏えいと判断 10分 温度センサ高警報、充てんポンプトリップ、加圧器水位、VCT水位、原子炉周辺建屋サンプ水位、RMS測定値(8~21N/B)、漏水注意等	③漏えい箇所の隔離等により漏えい停止 中央制御室において、抽出オリフィス出口格納容器第1隔離弁を遠隔手動閉止 1分	対象系統	系統保有水量(m ³) W2		系統漏えい量(m ³) W1	系統溢水量(m ³) W (=W1+W2)	手動隔離を期待(他系統との接続補給ラインあり)
抽出配管/非再冷却器入口(貫通部)~非再冷却器	漏えい量 オリフィスによる制限流量32.0m ³ /h 19分/60分×32.0m ³ /h=10.2m ³ 配管保有水量10.8m ³ 10.2m ³ +10.8m ³ =21.0m ³	合計時間(①+②+③) 19分		対象系統	系統保有水量(m ³) W2	系統漏えい量(m ³) W1	系統溢水量(m ³) W (=W1+W2)	手動隔離を期待	
抽出配管/非再冷却器出口(非再冷却器)~圧力制御弁				N71	CW	660	1,394	2,054	○
				P14	FW	11	77	88	○
				P43	TCW	11	19	30	○
				P45	BSW	55	146	201	○
				P46	TSW	33	222	255	○
				P48	HP/SW	11	40	51	○
				P13	M/WC	33	120	153	○
				循環水系		1420	1600	3020	○

赤字：設備、運用又は体制の相違（設計方針の相違）
 青字：記載箇所又は記載内容の相違（記載方針の相違）
 緑字：記載表現、設備名称の相違（実質的な相違なし）

第9条 溢水による損傷の防止等（別添1添付資料16）

大阪発電所3/4号炉		女川原子力発電所2号炉		泊発電所3号炉				相違理由	
表4 漏えい停止までの時間の設定及び漏えい量（主蒸気系）				表4 タービン建屋 系統別溢水量				女川は補足説明資料11「タービン建屋からの溢水影響評価に用いる溢水量について」にタービン建屋における想定破損の溢水量を掲載しているが、本資料においては記載がないため、比較対象なしとする。 【大阪】 記載方針の相違 大阪では系統の破断範囲ごとに隔離までの漏えい量を算出しているが、本資料内では、女川と同様の形でまとめる。別途、補足説明資料2「保有水量・系統別溢水量算出要領」にて、大阪と同様に算出した結果を記載する。	
表4 漏えい停止までの時間の設定及び漏えい量（主蒸気系） 漏えい量 172.7m ³ 主給水量 2020m ³ /h 補助給水量 430m ³ /h 10秒/3600秒×2020m ³ /h + 12分/60分×430m ³ /h = 91.7m ³ 配管保有水量 15m ³ 蒸気発生器保有水量 66m ³ 91.7+15+66=172.7m ³ 漏えい量 280.1m ³ 燃料「蒸気発生器の異常な増加」(2020m ³ /h×4ループ×10% = 812m ³ /h)では2次系弁（主蒸気速がし弁、タービンバイパス弁）の1弁の閉鎖を包括しているため、812m ³ /hを保守的に使用 補助給水量 430m ³ /h 11分/60分×430m ³ /h = 199.1m ³ 配管保有水量 15m ³ 蒸気発生器保有水量 66m ³ 199.1+15+66=280.1m ³ ※合計時間(10分60秒)	合計時間 (①+②+③) 12分2秒 17分	①漏えい箇所の隔離等により漏えい停止 中央制御室において、電動補助給水ライン流調弁、タービン補助給水ライン流調弁を遠隔手動閉止する。 2分(1分/個)	中央制御室において原子炉トリップ操作を行い、トリップ後の状況を確認。その後、電動補助給水ライン流調弁、タービン補助給水ライン流調弁を遠隔手動閉止する。 7分	②事業の再開及び漏えい箇所の特定 以下のパラメータから隔離する蒸気発生器を特定 SG 水位偏差、SG 流量偏差、主蒸気ライン圧力差、主蒸気・主給水配管差温度等	以下のパラメータから隔離する蒸気発生器を特定 SG 水位偏差、SG 流量偏差、主蒸気・主給水配管差温度高警報等	①異常の検知 <システム検知> 主蒸気ライン圧力低により中央制御室に警報が発信 また、主蒸気ライン圧力低により主給水閉鎖弁が自動閉止 10秒	<システム検知> 主給水流量と主蒸気流量の不一致警報が中央制御室に発信 0分		想定範囲 主蒸気管 主蒸気速がし弁、主蒸気隔離弁、バイパス配管（主蒸気管分岐～隔離弁）、主蒸気ドレン配管（一般部）、タービン補助給水ポンプ駆動用蒸気配管（主蒸気管分岐～隔離弁～TE）

赤字：設備、運用又は体制の相違（設計方針の相違）
 青字：記載箇所又は記載内容の相違（記載方針の相違）
 緑字：記載表現、設備名称の相違（実質的な相違なし）

大阪発電所3/4号炉		女川原子力発電所2号炉		泊発電所3号炉		相違理由		
表5 漏えい停止までの時間の設定及び漏えい量（主給水系）								
(1/2)								
想定範囲	①異常の検知	②事象の判断及び漏えい箇所の特定	③漏えい箇所の隔離等により漏えい停止	合計時間 (①+②+③)	漏えい量			
主給水管 (貫通部～ 逆止弁)	<システム検知> 主蒸気ライン圧力低により中央制 御室に警報発信 8秒 また、主蒸気ライン圧力低(S+RT) により主給水制御弁自動閉止 15秒	以下のパラメータから 漏えい箇所を特定 隔離する蒸気発生器を 10分 SG水位偏差、SG流量偏 差、主蒸気ライン圧力 低、主蒸気・主給水配管 室温度等	中央制御室において、 電動補助給水ライン流 量調節弁、タービン動 補助給水ライン流量調 節弁を遠隔手動閉止 2分(1分/個)	12分8秒	漏えい量175.5m ³ 主給水流量 2030m ³ /h 補助給水流量 430m ³ /h 15秒/3600秒×2030m ³ /h= 94.5m ³ +12分/60分×430m ³ /h= 86m ³ 配管保有水量 15m ³ 蒸気発生器保有水量 66m ³ 94.5+15+66=175.5m ³			
主給水管 (逆止弁～上流)	<システム検知> SG水位低による原子炉トリップ 50秒 また、Tavg 低による主給水制御弁 の自動閉止 110秒	自動隔離のため判断時 間なし 0分	自動隔離のため操作時 間なし 0分	110秒	漏えい量77.1m ³ 主給水流量 2030m ³ /h 110秒/3600秒×2030m ³ /h =62.1m ³ 配管保有水 15m ³ 62.1+15=77.1m ³			
				表5 出入管理建屋 系統別溢水量				
				対象系統	系統保有水量 (m ³)	系統漏えい量 (m ³)	系統溢水量 (m ³)	手動隔離を期待
				水消火系	W2	W1	W (=W1+W2)	○
				原子炉補給水系 (脱塩水)	5.0	242.4	247.2	○
				飲料水系	17.0	235.2	252.2	○
<p>【女川】 設計方針の相違 炉型の違いにより比較対象なし。</p> <p>【大阪】 記載方針の相違 大阪では系統の破断範囲ごとに隔 離までの漏えい量を算出して いる。泊でも同様の算出を実施して いるが、本資料内では、女川と同 様の形でまとめる。別途、補足説 明資料2「保有水量・系統別溢水 量算出要領」にて、大阪と同様に 算出した結果を記載する。</p>								

赤字：設備、運用又は体制の相違（設計方針の相違）
 青字：記載箇所又は記載内容の相違（記載方針の相違）
 緑字：記載表現、設備名称の相違（実質的な相違なし）

大阪発電所3/4号炉		女川原子力発電所2号炉		泊発電所3号炉		相違理由																												
表5 漏えい停止までの時間の設定及び漏えい量（主給水系） (2/2)				表6 電気建屋 系統別溢水量		<p>【女川】 設計方針の相違 炉型の違いにより比較対象なし。</p> <p>【大阪】 記載方針の相違 大阪では系統の破断範囲ごとに隔離までの漏えい量を算出しているが、本資料内では、女川と同様の形でまとめる。別途、補足説明資料2「保有水量・系統別溢水量算出要領」にて、大阪と同様に算出した結果を記載する。</p>																												
<table border="1"> <thead> <tr> <th>想定範囲</th> <th>①異常の検知</th> <th>②事象の判断及び漏えい箇所の特定</th> <th>③漏えい箇所の隔離等により漏えい停止</th> <th>合計時間 (①)+(②)+(③)</th> <th>漏えい量</th> </tr> </thead> <tbody> <tr> <td>主給水バイパス配管 (下流分岐～制御弁)</td> <td><システム検知> 主給水流量と主蒸気流量の不一致警報が中央制御室に発信 0分</td> <td>以下のパラメータから隔離する蒸気発生器を特定 10分 SG 水位偏差、SG 流量偏差、主蒸気・主給水配管室温度等</td> <td>中央制御室において、原子炉トリップ操作を確認 5分 また、原子炉手動トリップ操作後約60秒で原子炉トリップしゃ断器開+Tavg 低により主給水制御弁は自動閉止 60秒</td> <td>11分</td> <td>漏えい量387.2m³ 主給水流量2030m³/h 11分/60分×2030m³/h=372.2m³ 配管保有水15m³ 372.2m³+15m³=387.2m³</td> </tr> <tr> <td>主給水バイパス配管 (制御弁～上流分岐)</td> <td><システム検知> SG 水位低による原子炉トリップ 50秒 また、Tavg 低による主給水制御弁の自動閉止 110秒</td> <td>以下のパラメータから隔離する蒸気発生器を特定 10分 SG 水位偏差、SG 流量偏差、SG 水位低による原子炉トリップ、主蒸気・主給水配管室温度等</td> <td>中央制御室において、主給水ポンプ2台を遠隔手動停止 7分 (操作2分(1分/台)、停止5分、合わせて7分)</td> <td>17分50秒</td> <td>漏えい量618.4m³ 主給水流量2030m³/h 1070秒/3600秒×2030m³/h=603.4m³ 配管保有水15m³ 603.4m³+15m³=618.4m³</td> </tr> </tbody> </table>	想定範囲	①異常の検知	②事象の判断及び漏えい箇所の特定	③漏えい箇所の隔離等により漏えい停止	合計時間 (①)+(②)+(③)		漏えい量	主給水バイパス配管 (下流分岐～制御弁)	<システム検知> 主給水流量と主蒸気流量の不一致警報が中央制御室に発信 0分	以下のパラメータから隔離する蒸気発生器を特定 10分 SG 水位偏差、SG 流量偏差、主蒸気・主給水配管室温度等	中央制御室において、原子炉トリップ操作を確認 5分 また、原子炉手動トリップ操作後約60秒で原子炉トリップしゃ断器開+Tavg 低により主給水制御弁は自動閉止 60秒	11分	漏えい量387.2m ³ 主給水流量2030m ³ /h 11分/60分×2030m ³ /h=372.2m ³ 配管保有水15m ³ 372.2m ³ +15m ³ =387.2m ³	主給水バイパス配管 (制御弁～上流分岐)	<システム検知> SG 水位低による原子炉トリップ 50秒 また、Tavg 低による主給水制御弁の自動閉止 110秒	以下のパラメータから隔離する蒸気発生器を特定 10分 SG 水位偏差、SG 流量偏差、SG 水位低による原子炉トリップ、主蒸気・主給水配管室温度等	中央制御室において、主給水ポンプ2台を遠隔手動停止 7分 (操作2分(1分/台)、停止5分、合わせて7分)	17分50秒	漏えい量618.4m ³ 主給水流量2030m ³ /h 1070秒/3600秒×2030m ³ /h=603.4m ³ 配管保有水15m ³ 603.4m ³ +15m ³ =618.4m ³	<table border="1"> <thead> <tr> <th>対象系統</th> <th>系統保有水量 (m³)</th> <th>系統漏えい量 (m³)</th> <th>系統溢水量 (m³)</th> <th>手動隔離を期待</th> </tr> </thead> <tbody> <tr> <td>水消火系</td> <td>W2</td> <td>W1</td> <td>W (=W1+W2)</td> <td>○</td> </tr> <tr> <td></td> <td>25.0</td> <td>40.0</td> <td>65.0</td> <td></td> </tr> </tbody> </table>	対象系統	系統保有水量 (m ³)	系統漏えい量 (m ³)	系統溢水量 (m ³)	手動隔離を期待	水消火系	W2	W1	W (=W1+W2)	○		25.0	40.0	65.0
想定範囲	①異常の検知	②事象の判断及び漏えい箇所の特定	③漏えい箇所の隔離等により漏えい停止	合計時間 (①)+(②)+(③)	漏えい量																													
主給水バイパス配管 (下流分岐～制御弁)	<システム検知> 主給水流量と主蒸気流量の不一致警報が中央制御室に発信 0分	以下のパラメータから隔離する蒸気発生器を特定 10分 SG 水位偏差、SG 流量偏差、主蒸気・主給水配管室温度等	中央制御室において、原子炉トリップ操作を確認 5分 また、原子炉手動トリップ操作後約60秒で原子炉トリップしゃ断器開+Tavg 低により主給水制御弁は自動閉止 60秒	11分	漏えい量387.2m ³ 主給水流量2030m ³ /h 11分/60分×2030m ³ /h=372.2m ³ 配管保有水15m ³ 372.2m ³ +15m ³ =387.2m ³																													
主給水バイパス配管 (制御弁～上流分岐)	<システム検知> SG 水位低による原子炉トリップ 50秒 また、Tavg 低による主給水制御弁の自動閉止 110秒	以下のパラメータから隔離する蒸気発生器を特定 10分 SG 水位偏差、SG 流量偏差、SG 水位低による原子炉トリップ、主蒸気・主給水配管室温度等	中央制御室において、主給水ポンプ2台を遠隔手動停止 7分 (操作2分(1分/台)、停止5分、合わせて7分)	17分50秒	漏えい量618.4m ³ 主給水流量2030m ³ /h 1070秒/3600秒×2030m ³ /h=603.4m ³ 配管保有水15m ³ 603.4m ³ +15m ³ =618.4m ³																													
対象系統	系統保有水量 (m ³)	系統漏えい量 (m ³)	系統溢水量 (m ³)	手動隔離を期待																														
水消火系	W2	W1	W (=W1+W2)	○																														
	25.0	40.0	65.0																															

赤字：設備、運用又は体制の相違（設計方針の相違）
 青字：記載箇所又は記載内容の相違（記載方針の相違）
 緑字：記載表現、設備名称の相違（実質的な相違なし）

第9条 溢水による損傷の防止等（別添1添付資料16）

大阪発電所3/4号炉		女川原子力発電所2号炉		泊発電所3号炉		相違理由					
表6 漏えい停止までの時間の設定及び漏えい量（蒸気発生器ブローダウン系）		表4 軽油タンクエアリ 系統別溢水量									
想定範囲 蒸気発生器ブローダウン配管（貫通部～隔離弁）	①異常の検知 <システム検知> 主給水流量と主蒸気流量の不一致警報が中央制御室に発信 0分	②事象の判断及び漏えい箇所の特定 以下のパラメータから隔離する蒸気発生器を特定 10分 SG 水位偏差、SG 流量偏差、主蒸気・主給水配管塞風度等	③漏えい箇所の隔離等 により漏えい停止 中央制御室において原子炉トリップ操作を行い、トリップ後の状況を確認 その後、電動補助給水ライン流量調節弁、タービン駆動補助給水ライン流量調節弁を遠隔手動閉止 7分	④漏えい量 漏えい量 247.5m ³ 限界流量 707m ³ /h（口径 3B、SG 圧力 61.5kg/cm ² より） 補助給水流量 430m ³ /h 11分*（60分×707m ³ /h÷7分/60分×430m ³ /h） =179.5m ³ 配管保有水量 2.0m ³ 蒸気発生器保有水量 66m ³ 179.5m ³ +2.0m ³ +66m ³ =247.5m ³ ※合計時間（10分+60秒） 漏えい量 23.6m ³ 限界流量 707m ³ /h（口径 3B、SG 圧力 61.5kg/cm ² より） 107秒/3600秒×707m ³ /h =21.1m ³ 配管保有水量 2.5m ³ 21.1m ³ +2.5m ³ =23.6m ³	合計時間 (①+②+③) 17分	合計時間 107秒					
蒸気発生器ブローダウン配管（隔離弁～アングル弁）	<システム検知> SG 水位低による原子炉トリップ 100秒 また、SG 水位低によるブローダウンライン格納容器隔離弁自動閉止 107秒	自動隔離のため判断時間なし 0分	自動隔離のため操作時間なし 0分	対象系統	系統保有水量 (m ³) W2	系統漏えい量 (m ³) W1	系統溢水量 (m ³) W (=W1+W2)	手動隔離を期待（他系統との接続補給ラインあり）			
				R43, R44	DGDO	11	12	23	○		

【女川】
 設計方針の相違
 炉型の違いにより比較対象なし。

【大阪】
 記載方針の相違
 大阪では系統の破断範囲ごとに隔離までの漏えい量を算出しているが、本資料内では、女川と同様の形でまとめる。別途、補足説明資料2「保有水量・系統別溢水量算出要領」にて、大阪と同様に算出した結果を記載する。

赤字：設備、運用又は体制の相違（設計方針の相違）
 青字：記載箇所又は記載内容の相違（記載方針の相違）
 緑字：記載表現、設備名称の相違（実質的な相違なし）

第9条 溢水による損傷の防止等（別添1添付資料16）

大阪発電所3/4号炉	女川原子力発電所2号炉	泊発電所3号炉	相違理由																														
<p>表7 漏えい停止までの時間の設定及び漏えい量（補助給水系）</p> <table border="1" data-bbox="168 215 622 1388"> <thead> <tr> <th>想定範囲</th> <th>①異常の検知</th> <th>②事象の判断及び漏えい箇所の特定</th> <th>③漏えい箇所の隔離等により漏えい停止</th> <th>合計時間 (①+②+③)</th> <th>漏えい量</th> </tr> </thead> <tbody> <tr> <td>補助給水配管 (主給水管分岐 ～逆止弁)</td> <td><システム検知> 主給水流量と主蒸気流量の不一致警報が中央制御室に発信 0分</td> <td>以下のパラメータから隔離する蒸気発生器を特定 10分 SG 水位偏差、SG 流量偏差、主蒸気・主給水配管 室温度等</td> <td>中央制御室において原子炉トリップ操作を行い、トリップ後の状況を確認 その後、電動補助給水ライン流量調節弁、タービン動補助給水ライン流量調節弁を遠隔手動閉止 7分 (トリップ後の状況確認5分、操作2分(1分/個)合わせて7分) また、原子炉手動トリップ操作後約60秒で原子炉トリップしや断器開+Tag低により主給水制御弁は自動閉止 60秒</td> <td>17分</td> <td>漏えい量294.7m³ 臨界流量892m³/h (口径30、SG圧力61.5kg/cm²より) 補助給水流量430m³/h 11分[※]/60分×892m³/h+ 7分/60分×430m³/h =213.7m³ 配管保有水量15.0m³ 蒸気発生器保有水量66m³ 213.7m³+15m³+66m³ =294.7m³ ※合計時間(10分+60秒)</td> </tr> </tbody> </table>	想定範囲	①異常の検知	②事象の判断及び漏えい箇所の特定	③漏えい箇所の隔離等により漏えい停止	合計時間 (①+②+③)	漏えい量	補助給水配管 (主給水管分岐 ～逆止弁)	<システム検知> 主給水流量と主蒸気流量の不一致警報が中央制御室に発信 0分	以下のパラメータから隔離する蒸気発生器を特定 10分 SG 水位偏差、SG 流量偏差、主蒸気・主給水配管 室温度等	中央制御室において原子炉トリップ操作を行い、トリップ後の状況を確認 その後、電動補助給水ライン流量調節弁、タービン動補助給水ライン流量調節弁を遠隔手動閉止 7分 (トリップ後の状況確認5分、操作2分(1分/個)合わせて7分) また、原子炉手動トリップ操作後約60秒で原子炉トリップしや断器開+Tag低により主給水制御弁は自動閉止 60秒	17分	漏えい量294.7m ³ 臨界流量892m ³ /h (口径30、SG圧力61.5kg/cm ² より) 補助給水流量430m ³ /h 11分 [※] /60分×892m ³ /h+ 7分/60分×430m ³ /h =213.7m ³ 配管保有水量15.0m ³ 蒸気発生器保有水量66m ³ 213.7m ³ +15m ³ +66m ³ =294.7m ³ ※合計時間(10分+60秒)	<p>表5 原子炉建屋付属棟（廃棄物処理エリア（非管理区域））系統別溢水量</p> <table border="1" data-bbox="698 239 1270 367"> <thead> <tr> <th colspan="2">対象系統</th> <th>系統保有水量 (m³) W2</th> <th>系統漏えい量 (m³) W1</th> <th>系統溢水量 (m³) W=(W1+W2)</th> <th>手動隔離を期待 (他系統との接続 補給ラインあり)</th> </tr> </thead> <tbody> <tr> <td>P24</td> <td>HNCW</td> <td>33</td> <td>8</td> <td>41</td> <td>○</td> </tr> <tr> <td>P64</td> <td>HWH</td> <td>22</td> <td>32</td> <td>54</td> <td>○</td> </tr> </tbody> </table>	対象系統		系統保有水量 (m ³) W2	系統漏えい量 (m ³) W1	系統溢水量 (m ³) W=(W1+W2)	手動隔離を期待 (他系統との接続 補給ラインあり)	P24	HNCW	33	8	41	○	P64	HWH	22	32	54	○		<p>【女川】 <u>設計方針の相違</u> 炉型の違いにより比較対象なし。</p> <p>【大阪】 <u>記載方針の相違</u> 大阪では系統の破断範囲ごとに隔離までの漏えい量を算出しているが、本資料内では、女川と同様の形でまとめる。別途、補足説明資料2「保有水量・系統別溢水量算出要領」にて、大阪と同様に算出した結果を記載する。</p>
想定範囲	①異常の検知	②事象の判断及び漏えい箇所の特定	③漏えい箇所の隔離等により漏えい停止	合計時間 (①+②+③)	漏えい量																												
補助給水配管 (主給水管分岐 ～逆止弁)	<システム検知> 主給水流量と主蒸気流量の不一致警報が中央制御室に発信 0分	以下のパラメータから隔離する蒸気発生器を特定 10分 SG 水位偏差、SG 流量偏差、主蒸気・主給水配管 室温度等	中央制御室において原子炉トリップ操作を行い、トリップ後の状況を確認 その後、電動補助給水ライン流量調節弁、タービン動補助給水ライン流量調節弁を遠隔手動閉止 7分 (トリップ後の状況確認5分、操作2分(1分/個)合わせて7分) また、原子炉手動トリップ操作後約60秒で原子炉トリップしや断器開+Tag低により主給水制御弁は自動閉止 60秒	17分	漏えい量294.7m ³ 臨界流量892m ³ /h (口径30、SG圧力61.5kg/cm ² より) 補助給水流量430m ³ /h 11分 [※] /60分×892m ³ /h+ 7分/60分×430m ³ /h =213.7m ³ 配管保有水量15.0m ³ 蒸気発生器保有水量66m ³ 213.7m ³ +15m ³ +66m ³ =294.7m ³ ※合計時間(10分+60秒)																												
対象系統		系統保有水量 (m ³) W2	系統漏えい量 (m ³) W1	系統溢水量 (m ³) W=(W1+W2)	手動隔離を期待 (他系統との接続 補給ラインあり)																												
P24	HNCW	33	8	41	○																												
P64	HWH	22	32	54	○																												

赤字：設備、運用又は体制の相違（設計方針の相違）
 青字：記載箇所又は記載内容の相違（記載方針の相違）
 緑字：記載表現、設備名称の相違（実質的な相違なし）

第9条 溢水による損傷の防止等（別添1添付資料16）

大阪発電所3/4号炉	女川原子力発電所2号炉	泊発電所3号炉	相違理由																					
<p>表8 漏えい停止までの時間の設定及び漏えい量（補助蒸気系）</p> <table border="1" data-bbox="280 207 515 1388"> <tr> <td>想定範囲 補助蒸気供給配管</td> <td>①異常の検知 <温度検知> 温度センサー(60℃)の検知により 補助蒸気遮断弁が自動閉止 5分</td> <td>②事象の判断及び 漏えい箇所のため判断時間 自動隔離のため なし 0分</td> <td>③漏えい箇所の隔離等 により漏えい停止 自動隔離のため判断時 間なし 0分</td> <td>合計時間 (①)+(②)+(③) 5分</td> <td>漏えい量 3.7m³ スチームコンバータ容量 31.3m³/h(定格発生蒸気量 30t/hより)5分/60分× 31.3m³/h=2.7m³ 配管保有水量1.0m³ 2.7m³+1.0m³=3.7m³</td> </tr> </table>	想定範囲 補助蒸気供給配管	①異常の検知 <温度検知> 温度センサー(60℃)の検知により 補助蒸気遮断弁が自動閉止 5分	②事象の判断及び 漏えい箇所のため判断時間 自動隔離のため なし 0分	③漏えい箇所の隔離等 により漏えい停止 自動隔離のため判断時 間なし 0分	合計時間 (①)+(②)+(③) 5分	漏えい量 3.7m ³ スチームコンバータ容量 31.3m ³ /h(定格発生蒸気量 30t/hより)5分/60分× 31.3m ³ /h=2.7m ³ 配管保有水量1.0m ³ 2.7m ³ +1.0m ³ =3.7m ³		<p>表7 原子炉建屋系統別溢水量（地震起因）</p> <table border="1" data-bbox="1288 223 1848 367"> <thead> <tr> <th>対象系統</th> <th>系統保有水量 (m³) W2</th> <th>系統漏えい量 (m³) W1</th> <th>系統溢水量 (m³) W (=W1+W2)</th> <th>手動隔離を期待</th> </tr> </thead> <tbody> <tr> <td>気体廃棄物処理系</td> <td>0.5</td> <td>0</td> <td>0.5</td> <td>—</td> </tr> <tr> <td>空調用冷水系</td> <td>0.1</td> <td>0</td> <td>0.1</td> <td>—</td> </tr> </tbody> </table> <p>地震起因による溢水量(Wの合計値)=0.6m³</p>	対象系統	系統保有水量 (m ³) W2	系統漏えい量 (m ³) W1	系統溢水量 (m ³) W (=W1+W2)	手動隔離を期待	気体廃棄物処理系	0.5	0	0.5	—	空調用冷水系	0.1	0	0.1	—	<p>【女川】 設計方針の相違 炉型の違いにより比較対象なし。</p> <p>【大阪】 記載方針の相違 大阪では系統の破断範囲ごとに隔離までの漏えい量を算出しているが、本資料内では、女川と同様の形でまとめる。別途、補足説明資料2「保有水量・系統別溢水量算出要領」にて、大阪と同様に算出した結果を記載する。</p>
想定範囲 補助蒸気供給配管	①異常の検知 <温度検知> 温度センサー(60℃)の検知により 補助蒸気遮断弁が自動閉止 5分	②事象の判断及び 漏えい箇所のため判断時間 自動隔離のため なし 0分	③漏えい箇所の隔離等 により漏えい停止 自動隔離のため判断時 間なし 0分	合計時間 (①)+(②)+(③) 5分	漏えい量 3.7m ³ スチームコンバータ容量 31.3m ³ /h(定格発生蒸気量 30t/hより)5分/60分× 31.3m ³ /h=2.7m ³ 配管保有水量1.0m ³ 2.7m ³ +1.0m ³ =3.7m ³																			
対象系統	系統保有水量 (m ³) W2	系統漏えい量 (m ³) W1	系統溢水量 (m ³) W (=W1+W2)	手動隔離を期待																				
気体廃棄物処理系	0.5	0	0.5	—																				
空調用冷水系	0.1	0	0.1	—																				

赤字：設備、運用又は体制の相違（設計方針の相違）
 青字：記載箇所又は記載内容の相違（記載方針の相違）
 緑字：記載表現、設備名称の相違（実質的な相違なし）

大阪発電所3/4号炉	女川原子力発電所2号炉	泊発電所3号炉	相違理由																																																																																																																		
		<p style="text-align: center;">表8 原子炉補助建屋 系統別溢水量（地震起因）</p> <table border="1" style="width: 100%; border-collapse: collapse;"> <thead> <tr> <th>対象系統</th> <th>系統保有水量 (m³) W2</th> <th>系統漏えい量 (m³) W1</th> <th>系統溢水量 (m³) W (=W1+W2)</th> <th>手動隔離を期待</th> </tr> </thead> <tbody> <tr> <td>化学体積制御系</td> <td>0.3</td> <td>0</td> <td>0.3</td> <td>—</td> </tr> <tr> <td>液体廃棄物処理系</td> <td>2.5</td> <td>0</td> <td>2.5</td> <td>—</td> </tr> <tr> <td>廃液蒸発装置 (洗浄排水装置含む)</td> <td>0.5</td> <td>0</td> <td>0.5</td> <td>—</td> </tr> <tr> <td>セメント固化装置</td> <td>18.4</td> <td>0</td> <td>18.4</td> <td>—</td> </tr> </tbody> </table> <p>地震起因による溢水量 (Wの合計値) = 21.7m³</p>	対象系統	系統保有水量 (m ³) W2	系統漏えい量 (m ³) W1	系統溢水量 (m ³) W (=W1+W2)	手動隔離を期待	化学体積制御系	0.3	0	0.3	—	液体廃棄物処理系	2.5	0	2.5	—	廃液蒸発装置 (洗浄排水装置含む)	0.5	0	0.5	—	セメント固化装置	18.4	0	18.4	—	<p>【女川】 <u>設計方針の相違</u> プラント設計の違いにより比較対象なし。</p>																																																																																									
対象系統	系統保有水量 (m ³) W2	系統漏えい量 (m ³) W1	系統溢水量 (m ³) W (=W1+W2)	手動隔離を期待																																																																																																																	
化学体積制御系	0.3	0	0.3	—																																																																																																																	
液体廃棄物処理系	2.5	0	2.5	—																																																																																																																	
廃液蒸発装置 (洗浄排水装置含む)	0.5	0	0.5	—																																																																																																																	
セメント固化装置	18.4	0	18.4	—																																																																																																																	
	<p style="text-align: center;">表6 タービン建屋（管理区域） 系統別溢水量（地震起因）</p> <table border="1" style="width: 100%; border-collapse: collapse;"> <thead> <tr> <th>対象系統</th> <th>系統保有水量(m³) W2</th> <th>系統漏えい量(m³) W1</th> <th>系統溢水量(m³) W (=W1+W2)</th> </tr> </thead> <tbody> <tr><td>K11</td><td>ED</td><td>11</td><td>0</td><td>11</td></tr> <tr><td>K12</td><td>LCW</td><td>22</td><td>0</td><td>22</td></tr> <tr><td>K13</td><td>HCW</td><td>22</td><td>0</td><td>22</td></tr> <tr><td>K17</td><td>SD</td><td>22</td><td>0</td><td>22</td></tr> <tr><td>K21</td><td>SS</td><td>55</td><td>0</td><td>55</td></tr> <tr><td>N21</td><td>C, FOW</td><td>649</td><td>496</td><td>1,145</td></tr> <tr><td>N22</td><td>HD</td><td>330</td><td>0</td><td>330</td></tr> <tr><td>N26</td><td>CF</td><td>132</td><td>0</td><td>132</td></tr> <tr><td>N27</td><td>CD</td><td>209</td><td>0</td><td>209</td></tr> <tr><td>N32</td><td>EHC</td><td>11</td><td>0</td><td>11</td></tr> <tr><td>N34</td><td>LO</td><td>198</td><td>0</td><td>198</td></tr> <tr><td>N44</td><td>SWC</td><td>22</td><td>0</td><td>22</td></tr> <tr><td>N71</td><td>CW</td><td>1,200</td><td>2,770</td><td>3,970</td></tr> <tr><td>P11</td><td>MUWP</td><td>11</td><td>0</td><td>11</td></tr> <tr><td>P13</td><td>MUWC</td><td>33</td><td>0</td><td>33</td></tr> <tr><td>P14</td><td>FW</td><td>11</td><td>0</td><td>11</td></tr> <tr><td>P24</td><td>HNCW</td><td>110</td><td>0</td><td>110</td></tr> <tr><td>P42</td><td>RCW</td><td>66</td><td>0</td><td>66</td></tr> <tr><td>P43</td><td>TCW</td><td>231</td><td>0</td><td>231</td></tr> <tr><td>P62</td><td>HS/HSCR</td><td>19</td><td>0</td><td>19</td></tr> <tr><td>P64</td><td>HWH</td><td>33</td><td>0</td><td>33</td></tr> <tr><td>U43</td><td>FP</td><td>180</td><td>0</td><td>180</td></tr> </tbody> </table> <p>地震起因による溢水量(Wの合計値) = 6,843m³</p>	対象系統	系統保有水量(m ³) W2	系統漏えい量(m ³) W1	系統溢水量(m ³) W (=W1+W2)	K11	ED	11	0	11	K12	LCW	22	0	22	K13	HCW	22	0	22	K17	SD	22	0	22	K21	SS	55	0	55	N21	C, FOW	649	496	1,145	N22	HD	330	0	330	N26	CF	132	0	132	N27	CD	209	0	209	N32	EHC	11	0	11	N34	LO	198	0	198	N44	SWC	22	0	22	N71	CW	1,200	2,770	3,970	P11	MUWP	11	0	11	P13	MUWC	33	0	33	P14	FW	11	0	11	P24	HNCW	110	0	110	P42	RCW	66	0	66	P43	TCW	231	0	231	P62	HS/HSCR	19	0	19	P64	HWH	33	0	33	U43	FP	180	0	180		<p>【女川】 <u>設計方針の相違</u> 泊のタービン建屋には管理区域がないため、比較対象なしとし、女川のタービン建屋（非管理区域）と泊のタービン建屋を比較する。</p>
対象系統	系統保有水量(m ³) W2	系統漏えい量(m ³) W1	系統溢水量(m ³) W (=W1+W2)																																																																																																																		
K11	ED	11	0	11																																																																																																																	
K12	LCW	22	0	22																																																																																																																	
K13	HCW	22	0	22																																																																																																																	
K17	SD	22	0	22																																																																																																																	
K21	SS	55	0	55																																																																																																																	
N21	C, FOW	649	496	1,145																																																																																																																	
N22	HD	330	0	330																																																																																																																	
N26	CF	132	0	132																																																																																																																	
N27	CD	209	0	209																																																																																																																	
N32	EHC	11	0	11																																																																																																																	
N34	LO	198	0	198																																																																																																																	
N44	SWC	22	0	22																																																																																																																	
N71	CW	1,200	2,770	3,970																																																																																																																	
P11	MUWP	11	0	11																																																																																																																	
P13	MUWC	33	0	33																																																																																																																	
P14	FW	11	0	11																																																																																																																	
P24	HNCW	110	0	110																																																																																																																	
P42	RCW	66	0	66																																																																																																																	
P43	TCW	231	0	231																																																																																																																	
P62	HS/HSCR	19	0	19																																																																																																																	
P64	HWH	33	0	33																																																																																																																	
U43	FP	180	0	180																																																																																																																	

赤字：設備、運用又は体制の相違（設計方針の相違）
 青字：記載箇所又は記載内容の相違（記載方針の相違）
 緑字：記載表現、設備名称の相違（実質的な相違なし）

大阪発電所3/4号炉	女川原子力発電所2号炉	泊発電所3号炉	相違理由																																																																																																																																							
	<p>表7 タービン建屋（非管理区域）系統別溢水量（地震起因）</p> <table border="1" data-bbox="696 220 1265 507"> <thead> <tr> <th>対象系統</th> <th>系統保有水量(m³) W2</th> <th>系統漏えい量(m³) W1</th> <th>系統溢水量(m³) W (=W1+W2)</th> </tr> </thead> <tbody> <tr><td>F11</td><td>11</td><td>0</td><td>11</td></tr> <tr><td>P14</td><td>11</td><td>0</td><td>11</td></tr> <tr><td>P24</td><td>110</td><td>0</td><td>110</td></tr> <tr><td>P42</td><td>66</td><td>0</td><td>66</td></tr> <tr><td>P43</td><td>231</td><td>0</td><td>231</td></tr> <tr><td>P46</td><td>99</td><td>75</td><td>174</td></tr> <tr><td>P62</td><td>19</td><td>0</td><td>19</td></tr> <tr><td>U43</td><td>180</td><td>0</td><td>180</td></tr> <tr><td>U63</td><td>22</td><td>0</td><td>22</td></tr> </tbody> </table> <p>地震起因による溢水量(W2の合計値) = 821m³</p>	対象系統	系統保有水量(m³) W2	系統漏えい量(m³) W1	系統溢水量(m³) W (=W1+W2)	F11	11	0	11	P14	11	0	11	P24	110	0	110	P42	66	0	66	P43	231	0	231	P46	99	75	174	P62	19	0	19	U43	180	0	180	U63	22	0	22	<p>表9 タービン建屋 系統別溢水量（地震起因）</p> <table border="1" data-bbox="1283 220 1852 775"> <thead> <tr> <th>対象系統</th> <th>系統保有水量 (m³) W2</th> <th>系統漏えい量 (m³) W1</th> <th>系統溢水量 (m³) W (=W1+W2)</th> <th>手動隔離を期待</th> </tr> </thead> <tbody> <tr><td>主蒸気及び給水系</td><td>126.98</td><td>0</td><td>126.98</td><td>—</td></tr> <tr><td>蒸気発生器</td><td>6.71</td><td>0</td><td>6.71</td><td>—</td></tr> <tr><td>ブローダウン系</td><td>—</td><td>—</td><td>—</td><td>—</td></tr> <tr><td>原子炉補給水系 (脱塩水)</td><td>10.436</td><td>0</td><td>10.436</td><td>—</td></tr> <tr><td>補助蒸気系</td><td>0.65</td><td>0</td><td>0.65</td><td>—</td></tr> <tr><td>復水系</td><td>242.28</td><td>0</td><td>242.28</td><td>—</td></tr> <tr><td>循環水系</td><td>77.434</td><td>28367</td><td>28444.43</td><td>○</td></tr> <tr><td>軸受冷却系</td><td>150.67</td><td>0</td><td>150.67</td><td>—</td></tr> <tr><td>薬液注入装置</td><td>30.15</td><td>0</td><td>30.15</td><td>—</td></tr> <tr><td>排水処理設備</td><td>9.64</td><td>0</td><td>9.64</td><td>—</td></tr> <tr><td>タービン動主給水</td><td>130.12</td><td>0</td><td>130.12</td><td>—</td></tr> <tr><td>ポンプ油系</td><td>—</td><td>—</td><td>—</td><td>—</td></tr> <tr><td>スチーム</td><td>19.19</td><td>0</td><td>19.19</td><td>—</td></tr> <tr><td>コンバータ系</td><td>—</td><td>—</td><td>—</td><td>—</td></tr> <tr><td>タービン</td><td>4</td><td>0</td><td>4</td><td>—</td></tr> <tr><td>グラント蒸気系</td><td>—</td><td>—</td><td>—</td><td>—</td></tr> <tr><td>固定子冷却水供給装置</td><td>3.43</td><td>0</td><td>3.43</td><td>—</td></tr> <tr><td>密封前処理装置</td><td>0.58</td><td>0</td><td>0.58</td><td>—</td></tr> </tbody> </table> <p>地震起因による溢水量(Wの合計値) = 40979.47m³ ※ タービン建屋周辺の屋外タンク保有水量9600m³含む</p>	対象系統	系統保有水量 (m³) W2	系統漏えい量 (m³) W1	系統溢水量 (m³) W (=W1+W2)	手動隔離を期待	主蒸気及び給水系	126.98	0	126.98	—	蒸気発生器	6.71	0	6.71	—	ブローダウン系	—	—	—	—	原子炉補給水系 (脱塩水)	10.436	0	10.436	—	補助蒸気系	0.65	0	0.65	—	復水系	242.28	0	242.28	—	循環水系	77.434	28367	28444.43	○	軸受冷却系	150.67	0	150.67	—	薬液注入装置	30.15	0	30.15	—	排水処理設備	9.64	0	9.64	—	タービン動主給水	130.12	0	130.12	—	ポンプ油系	—	—	—	—	スチーム	19.19	0	19.19	—	コンバータ系	—	—	—	—	タービン	4	0	4	—	グラント蒸気系	—	—	—	—	固定子冷却水供給装置	3.43	0	3.43	—	密封前処理装置	0.58	0	0.58	—	<p>【女川】</p> <p>記載表現の相違 泊のタービン建屋には管理区域はないため、管理区域と非管理区域の識別はしない。</p> <p>設計方針の相違 ・プラント設計による建屋名称、対象系統、保有水量、漏えい量、溢水量、隔離手段の相違。女川では、地震の手動隔離に期待していない。</p> <p>・女川では、「手動隔離を期待（他系統との接続補給ラインあり）」としているが、泊では、他系統との接続補給ラインがなくても、手動隔離に期待した隔離時間にて系統漏えい量を算出していることから、「手動隔離を期待」のみとした。</p> <p>・また、中央制御室での手動隔離に期待している系統について、「○（中央制御室内での手動隔離）」と記載した。</p>
対象系統	系統保有水量(m³) W2	系統漏えい量(m³) W1	系統溢水量(m³) W (=W1+W2)																																																																																																																																							
F11	11	0	11																																																																																																																																							
P14	11	0	11																																																																																																																																							
P24	110	0	110																																																																																																																																							
P42	66	0	66																																																																																																																																							
P43	231	0	231																																																																																																																																							
P46	99	75	174																																																																																																																																							
P62	19	0	19																																																																																																																																							
U43	180	0	180																																																																																																																																							
U63	22	0	22																																																																																																																																							
対象系統	系統保有水量 (m³) W2	系統漏えい量 (m³) W1	系統溢水量 (m³) W (=W1+W2)	手動隔離を期待																																																																																																																																						
主蒸気及び給水系	126.98	0	126.98	—																																																																																																																																						
蒸気発生器	6.71	0	6.71	—																																																																																																																																						
ブローダウン系	—	—	—	—																																																																																																																																						
原子炉補給水系 (脱塩水)	10.436	0	10.436	—																																																																																																																																						
補助蒸気系	0.65	0	0.65	—																																																																																																																																						
復水系	242.28	0	242.28	—																																																																																																																																						
循環水系	77.434	28367	28444.43	○																																																																																																																																						
軸受冷却系	150.67	0	150.67	—																																																																																																																																						
薬液注入装置	30.15	0	30.15	—																																																																																																																																						
排水処理設備	9.64	0	9.64	—																																																																																																																																						
タービン動主給水	130.12	0	130.12	—																																																																																																																																						
ポンプ油系	—	—	—	—																																																																																																																																						
スチーム	19.19	0	19.19	—																																																																																																																																						
コンバータ系	—	—	—	—																																																																																																																																						
タービン	4	0	4	—																																																																																																																																						
グラント蒸気系	—	—	—	—																																																																																																																																						
固定子冷却水供給装置	3.43	0	3.43	—																																																																																																																																						
密封前処理装置	0.58	0	0.58	—																																																																																																																																						

赤字：設備、運用又は体制の相違（設計方針の相違）
 青字：記載箇所又は記載内容の相違（記載方針の相違）
 緑字：記載表現、設備名称の相違（実質的な相違なし）

大阪発電所3/4号炉	女川原子力発電所2号炉	泊発電所3号炉	相違理由																																																																																																																																	
	<p>表8 原子炉建屋付属棟（廃棄物処理エリア（管理区域））系統別 溢水量（地震起因）</p> <table border="1" data-bbox="696 236 1267 727"> <thead> <tr> <th>対象系統</th> <th>系統保有水量(m³) W2</th> <th>系統漏えい量(m³) W1</th> <th>系統溢水量(m³) W (=W1+W2)</th> </tr> </thead> <tbody> <tr><td>K11</td><td>ED</td><td>33</td><td>0</td><td>33</td></tr> <tr><td>K12</td><td>LCW</td><td>1,232</td><td>0</td><td>1,232</td></tr> <tr><td>K13</td><td>HCW</td><td>616</td><td>0</td><td>616</td></tr> <tr><td>K17</td><td>SD</td><td>99</td><td>0</td><td>99</td></tr> <tr><td>K21</td><td>SS</td><td>979</td><td>0</td><td>979</td></tr> <tr><td>K22</td><td>CONW</td><td>88</td><td>23</td><td>111</td></tr> <tr><td>K23</td><td>SOL^{※1}</td><td>44</td><td>8</td><td>52</td></tr> <tr><td>P11</td><td>MUWP</td><td>11</td><td>60</td><td>71</td></tr> <tr><td>P13</td><td>MUWC</td><td>33</td><td>120</td><td>153</td></tr> <tr><td>P14</td><td>FW</td><td>11</td><td>54</td><td>65</td></tr> <tr><td>P24</td><td>HNCW</td><td>55</td><td>8</td><td>63</td></tr> <tr><td>P25</td><td>HECW</td><td>33(S^{※2})</td><td>8</td><td>41</td></tr> <tr><td>P42</td><td>RCW</td><td>121^{※2}</td><td>—</td><td>—</td></tr> <tr><td>P42</td><td>RCW</td><td>209(S^{※3}含有)^{※3}</td><td>32</td><td>241</td></tr> <tr><td>P62</td><td>HS/HSCR</td><td>22</td><td>0</td><td>22</td></tr> <tr><td>P64</td><td>HWH</td><td>33</td><td>32</td><td>65</td></tr> <tr><td>U43</td><td>FP</td><td>180</td><td>27</td><td>207</td></tr> </tbody> </table> <p>※1 休止設備であり現在保有水はないが、保有水があるものとして評価する。 ※2 RCW(A)及びRCW(B)の常用系保有水量の合計 ※3 常用系と非常用系の保有水量合計(保有水量が多いRCW(A)で評価) 地震起因による溢水量(W2の合計値(S^{※2}は除く))=3,557m³</p>	対象系統	系統保有水量(m ³) W2	系統漏えい量(m ³) W1	系統溢水量(m ³) W (=W1+W2)	K11	ED	33	0	33	K12	LCW	1,232	0	1,232	K13	HCW	616	0	616	K17	SD	99	0	99	K21	SS	979	0	979	K22	CONW	88	23	111	K23	SOL ^{※1}	44	8	52	P11	MUWP	11	60	71	P13	MUWC	33	120	153	P14	FW	11	54	65	P24	HNCW	55	8	63	P25	HECW	33(S ^{※2})	8	41	P42	RCW	121 ^{※2}	—	—	P42	RCW	209(S ^{※3} 含有) ^{※3}	32	241	P62	HS/HSCR	22	0	22	P64	HWH	33	32	65	U43	FP	180	27	207	<p>表10 出入管理建屋 系統別溢水量（地震起因）</p> <table border="1" data-bbox="1285 863 1852 1050"> <thead> <tr> <th>対象系統</th> <th>系統保有水量 (m³) W2</th> <th>系統漏えい量 (m³) W1</th> <th>系統溢水量 (m³) W (=W1+W2)</th> <th>手動隔離を要す</th> </tr> </thead> <tbody> <tr> <td>原子炉補給水系 (脱塩水)</td> <td>5</td> <td>335.7</td> <td>340.7</td> <td>○</td> </tr> <tr> <td>水消火系</td> <td>25</td> <td>656.5</td> <td>681.5</td> <td>○</td> </tr> <tr> <td>飲料水系</td> <td>17</td> <td>25.8</td> <td>42.8</td> <td>○</td> </tr> </tbody> </table> <p>地震起因による溢水量(Wの合計値) = 1065.0m³</p> <p>表11 電気建屋 系統別溢水量（地震起因）</p> <table border="1" data-bbox="1285 1102 1852 1289"> <thead> <tr> <th>対象系統</th> <th>系統保有水量 (m³) W2</th> <th>系統漏えい量 (m³) W1</th> <th>系統溢水量 (m³) W (=W1+W2)</th> <th>手動隔離を要す</th> </tr> </thead> <tbody> <tr> <td>原子炉補給水系 (脱塩水)</td> <td>5</td> <td>0</td> <td>5</td> <td>—</td> </tr> <tr> <td>水消火系</td> <td>25</td> <td>656.5</td> <td>681.5</td> <td>○</td> </tr> <tr> <td>飲料水系</td> <td>17</td> <td>25.8</td> <td>42.8</td> <td>○</td> </tr> </tbody> </table> <p>地震起因による溢水量(Wの合計値) = 729.3m³</p>	対象系統	系統保有水量 (m ³) W2	系統漏えい量 (m ³) W1	系統溢水量 (m ³) W (=W1+W2)	手動隔離を要す	原子炉補給水系 (脱塩水)	5	335.7	340.7	○	水消火系	25	656.5	681.5	○	飲料水系	17	25.8	42.8	○	対象系統	系統保有水量 (m ³) W2	系統漏えい量 (m ³) W1	系統溢水量 (m ³) W (=W1+W2)	手動隔離を要す	原子炉補給水系 (脱塩水)	5	0	5	—	水消火系	25	656.5	681.5	○	飲料水系	17	25.8	42.8	○	<p>【女川】 設計方針の相違 炉型の違いにより比較対象なし。</p> <p>【女川】 設計方針の相違 炉型の違いにより比較対象なし。</p> <p>【女川】 設計方針の相違 炉型の違いにより比較対象なし。</p>
対象系統	系統保有水量(m ³) W2	系統漏えい量(m ³) W1	系統溢水量(m ³) W (=W1+W2)																																																																																																																																	
K11	ED	33	0	33																																																																																																																																
K12	LCW	1,232	0	1,232																																																																																																																																
K13	HCW	616	0	616																																																																																																																																
K17	SD	99	0	99																																																																																																																																
K21	SS	979	0	979																																																																																																																																
K22	CONW	88	23	111																																																																																																																																
K23	SOL ^{※1}	44	8	52																																																																																																																																
P11	MUWP	11	60	71																																																																																																																																
P13	MUWC	33	120	153																																																																																																																																
P14	FW	11	54	65																																																																																																																																
P24	HNCW	55	8	63																																																																																																																																
P25	HECW	33(S ^{※2})	8	41																																																																																																																																
P42	RCW	121 ^{※2}	—	—																																																																																																																																
P42	RCW	209(S ^{※3} 含有) ^{※3}	32	241																																																																																																																																
P62	HS/HSCR	22	0	22																																																																																																																																
P64	HWH	33	32	65																																																																																																																																
U43	FP	180	27	207																																																																																																																																
対象系統	系統保有水量 (m ³) W2	系統漏えい量 (m ³) W1	系統溢水量 (m ³) W (=W1+W2)	手動隔離を要す																																																																																																																																
原子炉補給水系 (脱塩水)	5	335.7	340.7	○																																																																																																																																
水消火系	25	656.5	681.5	○																																																																																																																																
飲料水系	17	25.8	42.8	○																																																																																																																																
対象系統	系統保有水量 (m ³) W2	系統漏えい量 (m ³) W1	系統溢水量 (m ³) W (=W1+W2)	手動隔離を要す																																																																																																																																
原子炉補給水系 (脱塩水)	5	0	5	—																																																																																																																																
水消火系	25	656.5	681.5	○																																																																																																																																
飲料水系	17	25.8	42.8	○																																																																																																																																

赤字：設備、運用又は体制の相違（設計方針の相違）
 青字：記載箇所又は記載内容の相違（記載方針の相違）
 緑字：記載表現、設備名称の相違（実質的な相違なし）

大阪発電所3/4号炉	女川原子力発電所2号炉	泊発電所3号炉	相違理由																																																	
	<p>表9 補助ボイラー建屋 系統別溢水量（地震起因）</p> <table border="1" data-bbox="701 220 1263 539"> <thead> <tr> <th>対象系統</th> <th>系統保有水量(m³) W2</th> <th>系統漏えい量(m³) W1</th> <th>系統溢水量(m³) W(=W1+W2)</th> </tr> </thead> <tbody> <tr><td>P11</td><td>MUWP</td><td>11</td><td>13</td><td>24</td></tr> <tr><td>P43</td><td>TCW</td><td>22</td><td>47</td><td>69</td></tr> <tr><td>P61</td><td>HBMFW</td><td>33</td><td>44</td><td>77</td></tr> <tr><td>P61</td><td>HBFW</td><td>33</td><td>134</td><td>167</td></tr> <tr><td>P61</td><td>HBTCW</td><td>22</td><td>27</td><td>49</td></tr> <tr><td>P62</td><td>HSCR</td><td>11</td><td>24</td><td>35</td></tr> <tr><td>P64</td><td>HWH</td><td>22</td><td>21</td><td>43</td></tr> <tr><td>U43</td><td>FP</td><td>143</td><td>140</td><td>283</td></tr> <tr><td>U63</td><td>MSC</td><td>22</td><td>12</td><td>34</td></tr> </tbody> </table> <p>地震起因による溢水量(W2の合計値)= 319m³</p>	対象系統	系統保有水量(m ³) W2	系統漏えい量(m ³) W1	系統溢水量(m ³) W(=W1+W2)	P11	MUWP	11	13	24	P43	TCW	22	47	69	P61	HBMFW	33	44	77	P61	HBFW	33	134	167	P61	HBTCW	22	27	49	P62	HSCR	11	24	35	P64	HWH	22	21	43	U43	FP	143	140	283	U63	MSC	22	12	34		<p>【女川】 <u>設計方針の相違</u> プラント設計の違いにより比較対象なし。</p>
対象系統	系統保有水量(m ³) W2	系統漏えい量(m ³) W1	系統溢水量(m ³) W(=W1+W2)																																																	
P11	MUWP	11	13	24																																																
P43	TCW	22	47	69																																																
P61	HBMFW	33	44	77																																																
P61	HBFW	33	134	167																																																
P61	HBTCW	22	27	49																																																
P62	HSCR	11	24	35																																																
P64	HWH	22	21	43																																																
U43	FP	143	140	283																																																
U63	MSC	22	12	34																																																

赤字：設備、運用又は体制の相違（設計方針の相違）
 青字：記載箇所又は記載内容の相違（記載方針の相違）
 緑字：記載表現、設備名称の相違（実質的な相違なし）

大飯発電所3/4号炉	女川原子力発電所2号炉	泊発電所3号炉	相違理由																																																												
	<p style="text-align: center;">原子力発電所</p> <table border="1" style="width: 100%; border-collapse: collapse;"> <tr> <th colspan="2">異常時監視機能 (ADW/ADSD)</th> <th colspan="2">異常発生検知機能 (ADW/ADSD)</th> <th colspan="2">異常発生検知機能 (ADW/ADSD)</th> <th colspan="2">異常発生検知機能 (ADW/ADSD)</th> <th colspan="2">異常発生検知機能 (ADW/ADSD)</th> </tr> <tr> <td>監視機能</td> <td>検出機能</td> <td>監視機能</td> <td>検出機能</td> <td>監視機能</td> <td>検出機能</td> <td>監視機能</td> <td>検出機能</td> <td>監視機能</td> <td>検出機能</td> </tr> <tr> <td>○</td> <td>○</td> <td>○</td> <td>○</td> <td>○</td> <td>○</td> <td>○</td> <td>○</td> <td>○</td> <td>○</td> </tr> </table> <p style="text-align: center;">原子力発電所</p> <table border="1" style="width: 100%; border-collapse: collapse;"> <tr> <th colspan="2">異常時監視機能 (ADW/ADSD)</th> <th colspan="2">異常発生検知機能 (ADW/ADSD)</th> <th colspan="2">異常発生検知機能 (ADW/ADSD)</th> <th colspan="2">異常発生検知機能 (ADW/ADSD)</th> <th colspan="2">異常発生検知機能 (ADW/ADSD)</th> </tr> <tr> <td>監視機能</td> <td>検出機能</td> <td>監視機能</td> <td>検出機能</td> <td>監視機能</td> <td>検出機能</td> <td>監視機能</td> <td>検出機能</td> <td>監視機能</td> <td>検出機能</td> </tr> <tr> <td>○</td> <td>○</td> <td>○</td> <td>○</td> <td>○</td> <td>○</td> <td>○</td> <td>○</td> <td>○</td> <td>○</td> </tr> </table>	異常時監視機能 (ADW/ADSD)		異常発生検知機能 (ADW/ADSD)		異常発生検知機能 (ADW/ADSD)		異常発生検知機能 (ADW/ADSD)		異常発生検知機能 (ADW/ADSD)		監視機能	検出機能	監視機能	検出機能	監視機能	検出機能	監視機能	検出機能	監視機能	検出機能	○	○	○	○	○	○	○	○	○	○	異常時監視機能 (ADW/ADSD)		異常発生検知機能 (ADW/ADSD)		異常発生検知機能 (ADW/ADSD)		異常発生検知機能 (ADW/ADSD)		異常発生検知機能 (ADW/ADSD)		監視機能	検出機能	監視機能	検出機能	監視機能	検出機能	監視機能	検出機能	監視機能	検出機能	○	○	○	○	○	○	○	○	○	○		<p>【女川】</p> <p><u>設計方針の相違</u></p> <ul style="list-style-type: none"> 女川では、同時に複数区分の安全機能が機能喪失する結果となる評価ケースがあり、判定表による評価を実施している。 泊では、充てんポンプが機能喪失するケースが存在するが、多重性を有しており、3台のうち2台が機能維持するため問題がないことを補足説明資料10「A, B, C充てんポンプの没水影響評価」にて説明している。(大飯、高浜、美浜、川内と同様の考え方) 泊の想定破損による没水影響評価では、すべての防護対象が多重性を維持する結果となるため、判定表による評価は必要ない。(大飯と同様)
異常時監視機能 (ADW/ADSD)		異常発生検知機能 (ADW/ADSD)		異常発生検知機能 (ADW/ADSD)		異常発生検知機能 (ADW/ADSD)		異常発生検知機能 (ADW/ADSD)																																																							
監視機能	検出機能	監視機能	検出機能	監視機能	検出機能	監視機能	検出機能	監視機能	検出機能																																																						
○	○	○	○	○	○	○	○	○	○																																																						
異常時監視機能 (ADW/ADSD)		異常発生検知機能 (ADW/ADSD)		異常発生検知機能 (ADW/ADSD)		異常発生検知機能 (ADW/ADSD)		異常発生検知機能 (ADW/ADSD)																																																							
監視機能	検出機能	監視機能	検出機能	監視機能	検出機能	監視機能	検出機能	監視機能	検出機能																																																						
○	○	○	○	○	○	○	○	○	○																																																						

赤字：設備、運用又は体制の相違（設計方針の相違）
 青字：記載箇所又は記載内容の相違（記載方針の相違）
 緑字：記載表現、設備名称の相違（実質的な相違なし）

大飯発電所3/4号炉	女川原子力発電所2号炉	泊発電所3号炉	相違理由																																																																																				
	<div style="border: 2px solid red; padding: 5px;"> <p style="text-align: center;">東京電力</p> <table border="1" style="width: 100%; border-collapse: collapse;"> <tr> <td colspan="2">評価項目</td> <td colspan="2">東京電力</td> <td colspan="2">東京電力</td> <td colspan="2">東京電力</td> <td colspan="2">東京電力</td> <td colspan="2">東京電力</td> </tr> <tr> <td colspan="2">設備名称</td> <td colspan="2">設備名称</td> <td colspan="2">設備名称</td> <td colspan="2">設備名称</td> <td colspan="2">設備名称</td> <td colspan="2">設備名称</td> </tr> <tr> <td colspan="2">設備仕様</td> <td colspan="2">設備仕様</td> <td colspan="2">設備仕様</td> <td colspan="2">設備仕様</td> <td colspan="2">設備仕様</td> <td colspan="2">設備仕様</td> </tr> </table> <table border="1" style="width: 100%; border-collapse: collapse;"> <tr> <th colspan="2">東京電力</th> <th colspan="2">東京電力</th> <th colspan="2">東京電力</th> <th colspan="2">東京電力</th> <th colspan="2">東京電力</th> <th colspan="2">東京電力</th> </tr> <tr> <td>評価項目</td> <td>東京電力</td> <td>評価項目</td> <td>東京電力</td> <td>評価項目</td> <td>東京電力</td> <td>評価項目</td> <td>東京電力</td> <td>評価項目</td> <td>東京電力</td> <td>評価項目</td> <td>東京電力</td> </tr> <tr> <td>設備名称</td> <td>設備名称</td> <td>設備名称</td> <td>設備名称</td> <td>設備名称</td> <td>設備名称</td> <td>設備名称</td> <td>設備名称</td> <td>設備名称</td> <td>設備名称</td> <td>設備名称</td> <td>設備名称</td> </tr> <tr> <td>設備仕様</td> <td>設備仕様</td> <td>設備仕様</td> <td>設備仕様</td> <td>設備仕様</td> <td>設備仕様</td> <td>設備仕様</td> <td>設備仕様</td> <td>設備仕様</td> <td>設備仕様</td> <td>設備仕様</td> <td>設備仕様</td> </tr> </table> </div>	評価項目		東京電力		東京電力		東京電力		東京電力		東京電力		設備名称		設備名称		設備名称		設備名称		設備名称		設備名称		設備仕様		設備仕様		設備仕様		設備仕様		設備仕様		設備仕様		東京電力		東京電力		東京電力		東京電力		東京電力		東京電力		評価項目	東京電力	評価項目	東京電力	評価項目	東京電力	評価項目	東京電力	評価項目	東京電力	評価項目	東京電力	設備名称	設備名称	設備名称	設備名称	設備名称	設備名称	設備名称	設備名称	設備名称	設備名称	設備名称	設備名称	設備仕様	設備仕様	設備仕様	設備仕様	設備仕様	設備仕様	設備仕様	設備仕様	設備仕様	設備仕様	設備仕様	設備仕様		<p>【女川】</p> <p><u>設計方針の相違</u></p> <ul style="list-style-type: none"> ・女川では、同時に複数区分の安全機能が機能喪失する結果となる評価ケースがあり、判定表による評価を実施している。 ・泊では、充てんポンプが機能喪失するケースが存在するが、多重性を有しており、3台のうち2台が機能維持するため問題がないことを補足説明資料10「A、B、C充てんポンプの没水影響評価」にて説明している。（大飯、高浜、美浜、川内と同様の考え方） ・泊の想定破損による没水影響評価では、すべての防護対象が多重性を維持する結果となるため、判定表による評価は必要ない。（大飯と同様）
評価項目		東京電力		東京電力		東京電力		東京電力		東京電力																																																																													
設備名称		設備名称		設備名称		設備名称		設備名称		設備名称																																																																													
設備仕様		設備仕様		設備仕様		設備仕様		設備仕様		設備仕様																																																																													
東京電力		東京電力		東京電力		東京電力		東京電力		東京電力																																																																													
評価項目	東京電力	評価項目	東京電力	評価項目	東京電力	評価項目	東京電力	評価項目	東京電力	評価項目	東京電力																																																																												
設備名称	設備名称	設備名称	設備名称	設備名称	設備名称	設備名称	設備名称	設備名称	設備名称	設備名称	設備名称																																																																												
設備仕様	設備仕様	設備仕様	設備仕様	設備仕様	設備仕様	設備仕様	設備仕様	設備仕様	設備仕様	設備仕様	設備仕様																																																																												

赤字：設備、運用又は体制の相違（設計方針の相違）
 青字：記載箇所又は記載内容の相違（記載方針の相違）
 緑字：記載表現、設備名称の相違（実質的な相違なし）

大飯発電所3/4号炉										女川原子力発電所2号炉										泊発電所3号炉										相違理由
大阪3号炉 想定破損による溢水影響評価結果(4/7)										表1 没水影響評価結果整理表(想定破損)(4/7)																				【女川】【大飯】 記載表現の相違 【大飯】 記載方針の相違 ・大飯は、それぞれの系統の配管の破断箇所ごとに溢水影響評価をまとめている。 ・一方、泊はそれぞれの系統において、最も溢水量が大きくなる破断箇所を選定した上で、その溢水量を用いて破断する配管が設置されているすべての区画の評価を実施している。評価結果としての相違はない。 ・泊と同様のまとめ方をしている先行PWRとしては、伊方、川内、玄海があり、大飯の評価結果の後(9-別添1-添17-25)に伊方の評価結果を掲載する。 【女川】 記載方針の相違 ・女川は想定破損による溢水源が泊と比較して多いこと、溢水源が多く、各区画の溢水源のうち最も大きいものに対して、溢水による伝播を確認した結果を記載する。 ・泊は、多くの配管に対して、応力評価を実施することにより想定破損除外を適用し、溢水源を限定しているため、系統ごとに結果をまとめているが、没水影響評価で確認している内容に相違はない。 ・泊では、開口部からの流下で水位上昇が抑制される評価に該当する場合、表の備考欄に記載する。 設計方針の相違 プラント設計の違いによる評価結果の相違
<p>(1) 破断位置の想定位置 ・高エネルギー炉内(燃料棒位置)を以て ・高エネルギー炉内(燃料棒位置)を以て ・燃料棒位置を以て ・燃料棒位置を以て</p> <p>(2) 破断位置の想定位置 ・高エネルギー炉内(燃料棒位置)を以て ・高エネルギー炉内(燃料棒位置)を以て ・燃料棒位置を以て ・燃料棒位置を以て</p>										<p>(1) 破断位置の想定位置 ・高エネルギー炉内(燃料棒位置)を以て ・高エネルギー炉内(燃料棒位置)を以て ・燃料棒位置を以て ・燃料棒位置を以て</p> <p>(2) 破断位置の想定位置 ・高エネルギー炉内(燃料棒位置)を以て ・高エネルギー炉内(燃料棒位置)を以て ・燃料棒位置を以て ・燃料棒位置を以て</p>										<p>(1) 破断位置の想定位置 ・高エネルギー炉内(燃料棒位置)を以て ・高エネルギー炉内(燃料棒位置)を以て ・燃料棒位置を以て ・燃料棒位置を以て</p> <p>(2) 破断位置の想定位置 ・高エネルギー炉内(燃料棒位置)を以て ・高エネルギー炉内(燃料棒位置)を以て ・燃料棒位置を以て ・燃料棒位置を以て</p>										

赤字：設備、運用又は体制の相違（設計方針の相違）
 青字：記載箇所又は記載内容の相違（記載方針の相違）
 緑字：記載表現、設備名称の相違（実質的な相違なし）

大飯発電所3/4号炉	女川原子力発電所2号炉	泊発電所3号炉	相違理由																																		
	<div style="border: 2px solid red; padding: 5px;"> <p>設計種別 固定式凝縮</p> <p>設計者 株式会社 女川原子力</p> <p>設計標準 JIS</p> <table border="1" style="width: 100%; border-collapse: collapse;"> <thead> <tr> <th colspan="2" rowspan="2">設計種別</th> <th colspan="2">設計標準</th> <th colspan="2">設計標準</th> <th colspan="2">設計標準</th> <th colspan="2">設計標準</th> <th colspan="2">設計標準</th> </tr> <tr> <th>設計標準</th> <th>設計標準</th> <th>設計標準</th> <th>設計標準</th> <th>設計標準</th> <th>設計標準</th> <th>設計標準</th> <th>設計標準</th> <th>設計標準</th> <th>設計標準</th> </tr> </thead> <tbody> <tr> <td>設計標準</td> <td>設計標準</td> <td>設計標準</td> <td>設計標準</td> <td>設計標準</td> <td>設計標準</td> <td>設計標準</td> <td>設計標準</td> <td>設計標準</td> <td>設計標準</td> <td>設計標準</td> <td>設計標準</td> </tr> </tbody> </table> </div>	設計種別		設計標準		設計標準		設計標準		設計標準		設計標準		設計標準	設計標準	設計標準	設計標準	設計標準	設計標準	設計標準	設計標準	設計標準	設計標準	設計標準	設計標準	設計標準	設計標準	設計標準	設計標準	設計標準	設計標準	設計標準	設計標準	設計標準	設計標準		<p>【女川】</p> <p><u>設計方針の相違</u></p> <ul style="list-style-type: none"> 女川では、同時に複数区分の安全機能が機能喪失する結果となる評価ケースがあり、判定表による評価を実施している。 泊では、充てんポンプが機能喪失するケースが存在するが、多重性を有しており、3台のうち2台が機能維持するため問題がないことを補足説明資料10「A、B、C充てんポンプの没水影響評価」にて説明している。（大飯、高浜、美浜、川内と同様の考え方） 泊の想定破損による没水影響評価では、すべての防護対象が多重性を維持する結果となるため、判定表による評価は必要ない。（大飯と同様）
設計種別				設計標準		設計標準		設計標準		設計標準		設計標準																									
		設計標準	設計標準	設計標準	設計標準	設計標準	設計標準	設計標準	設計標準	設計標準	設計標準																										
設計標準	設計標準	設計標準	設計標準	設計標準	設計標準	設計標準	設計標準	設計標準	設計標準	設計標準	設計標準																										

赤字：設備、運用又は体制の相違（設計方針の相違）
 青字：記載箇所又は記載内容の相違（記載方針の相違）
 緑字：記載表現、設備名称の相違（実質的な相違なし）

第9条 溢水による損傷の防止等（別添1添付資料17）

大飯発電所3/4号炉										女川原子力発電所2号炉										泊発電所3号炉										相違理由
大阪4号炉 想定破損による溢水影響評価結果(2/6)																														
種別	区画区分	層別	エリア番号	①最大水量 (m³)	②層別面積 (㎡)	③層別平均水深 (m)	④溢水水位 (m)	⑤貯留対象設備	⑥破損想定高さ (床より) (m)	⑦影響評価	⑧判定	備考1	備考2																	
4号炉の 原子炉 周辺機器	28.0		409-1	31.8	273.3	0.09	0.114	-	-	②<④	-		使用済燃料貯蔵庫の安全確保																	
				4A. 使用済燃料使用水ポンプ	0.47	②<④	○																							
				4B. 原子炉圧力調整用圧入ポンプ	0.52	②<④	○																							
				4C. 原子炉圧力調整用冷却ファン	0.68	②<④	○																							
				4D. 安全機器冷却用ファン	0.82	②<④	○																							
				4E. 40 層別用冷却機組装置	0.78	②<④	○																							
				4F. 40 層別用圧縮機組装置	0.65	②>④	○*																							
				4G. 40 層別用圧縮機組装置	0.65	②>④	○*																							
				4H. 40 層別用圧縮機組装置	0.29	②>④	○*																							
				4I. 40 層別用圧縮機組装置	1.05	②<④	○																							
				4J. 40 層別用圧縮機組装置	0.72	②<④	○																							
				4K. 40 層別用圧縮機組装置	0.29	②<④	○																							
				4L. 40 層別用圧縮機組装置	1.08	②<④	○																							
				4M. 40 層別用圧縮機組装置	1.11	②<④	○																							
				4N. 40 層別用圧縮機組装置	0.50	②<④	○																							
4O. 40 層別用圧縮機組装置	0.50	②<④	○																											
4P. 40 層別用圧縮機組装置	0.172	0.09	0.081																											
4Q. 40 層別用圧縮機組装置	0.172	0.09	0.081																											
4R. 40 層別用圧縮機組装置	0.172	0.09	0.081																											
4S. 40 層別用圧縮機組装置	0.172	0.09	0.081																											
4T. 40 層別用圧縮機組装置	0.172	0.09	0.081																											
4U. 40 層別用圧縮機組装置	0.172	0.09	0.081																											
4V. 40 層別用圧縮機組装置	0.172	0.09	0.081																											
4W. 40 層別用圧縮機組装置	0.172	0.09	0.081																											
4X. 40 層別用圧縮機組装置	0.172	0.09	0.081																											
4Y. 40 層別用圧縮機組装置	0.172	0.09	0.081																											
4Z. 40 層別用圧縮機組装置	0.172	0.09	0.081																											

【大阪】
 設計方針の相違
 大阪はツインプラント。
 【女川】
 設計方針の相違
 プラント設計の違いによる評価結果の相違

設備名	設備番号	設備名称	設備高さ (m)	破損想定高さ (m)	影響評価	判定	備考
10P-201B	10P-201B	原子炉圧力調整用圧入ポンプ	3.105	3.105	②<④	○	
10P-201C	10P-201C	原子炉圧力調整用冷却ファン	3.145	3.145	②<④	○	
10P-201D	10P-201D	原子炉圧力調整用圧入ポンプ	3.145	3.145	②<④	○	
10P-201E	10P-201E	原子炉圧力調整用冷却ファン	3.145	3.145	②<④	○	
10P-201F	10P-201F	原子炉圧力調整用圧入ポンプ	3.145	3.145	②<④	○	
10P-201G	10P-201G	原子炉圧力調整用冷却ファン	3.145	3.145	②<④	○	
10P-201H	10P-201H	原子炉圧力調整用圧入ポンプ	3.145	3.145	②<④	○	
10P-201I	10P-201I	原子炉圧力調整用冷却ファン	3.145	3.145	②<④	○	
10P-201J	10P-201J	原子炉圧力調整用圧入ポンプ	3.145	3.145	②<④	○	
10P-201K	10P-201K	原子炉圧力調整用冷却ファン	3.145	3.145	②<④	○	
10P-201L	10P-201L	原子炉圧力調整用圧入ポンプ	3.145	3.145	②<④	○	
10P-201M	10P-201M	原子炉圧力調整用冷却ファン	3.145	3.145	②<④	○	
10P-201N	10P-201N	原子炉圧力調整用圧入ポンプ	3.145	3.145	②<④	○	
10P-201O	10P-201O	原子炉圧力調整用冷却ファン	3.145	3.145	②<④	○	
10P-201P	10P-201P	原子炉圧力調整用圧入ポンプ	3.145	3.145	②<④	○	
10P-201Q	10P-201Q	原子炉圧力調整用冷却ファン	3.145	3.145	②<④	○	
10P-201R	10P-201R	原子炉圧力調整用圧入ポンプ	3.145	3.145	②<④	○	
10P-201S	10P-201S	原子炉圧力調整用冷却ファン	3.145	3.145	②<④	○	
10P-201T	10P-201T	原子炉圧力調整用圧入ポンプ	3.145	3.145	②<④	○	
10P-201U	10P-201U	原子炉圧力調整用冷却ファン	3.145	3.145	②<④	○	
10P-201V	10P-201V	原子炉圧力調整用圧入ポンプ	3.145	3.145	②<④	○	
10P-201W	10P-201W	原子炉圧力調整用冷却ファン	3.145	3.145	②<④	○	
10P-201X	10P-201X	原子炉圧力調整用圧入ポンプ	3.145	3.145	②<④	○	
10P-201Y	10P-201Y	原子炉圧力調整用冷却ファン	3.145	3.145	②<④	○	
10P-201Z	10P-201Z	原子炉圧力調整用圧入ポンプ	3.145	3.145	②<④	○	



備考：設備の高さは、設備の設置位置が異なる場合は、設置位置の高さを採用する。
 破損想定高さは、設備の設置位置が異なる場合は、設置位置の高さを採用する。
 影響評価は、破損想定高さとの比較に基づき、②<④は破損しない、②>④は破損する、②=④は破損する可能性がある。
 判定は、破損しない場合は○、破損する場合は○*、破損する可能性がある場合は○△とする。
 備考欄には、破損する設備の名称、破損する高さ、破損する原因などを記載する。

赤字：設備、運用又は体制の相違（設計方針の相違）
 青字：記載箇所又は記載内容の相違（記載方針の相違）
 緑字：記載表現、設備名称の相違（実質的な相違なし）

第9条 溢水による損傷の防止等（別添1添付資料17）

大飯発電所3/4号炉	女川原子力発電所2号炉	泊発電所3号炉	相違理由																																																																																																																																																																																																																																																																																																																																																																																										
<p>大飯4号炉 想定破損による溢水影響評価結果(4/6)</p> <p>①2号炉の破損状況 破損原因：破断（破断原因：破断原因不明） 破損位置：2号炉（破断位置：2号炉） 破損時刻：19分（破断時刻：19分） 破断時刻：19分（破断時刻：19分）</p> <table border="1"> <thead> <tr> <th>破断時刻</th> <th>破断位置</th> <th>破断原因</th> <th>破断時刻</th> <th>破断位置</th> <th>破断原因</th> </tr> </thead> <tbody> <tr> <td>17.1</td> <td>2号炉</td> <td>破断</td> <td>17.1</td> <td>2号炉</td> <td>破断</td> </tr> <tr> <td>17.2</td> <td>2号炉</td> <td>破断</td> <td>17.2</td> <td>2号炉</td> <td>破断</td> </tr> <tr> <td>17.3</td> <td>2号炉</td> <td>破断</td> <td>17.3</td> <td>2号炉</td> <td>破断</td> </tr> <tr> <td>17.4</td> <td>2号炉</td> <td>破断</td> <td>17.4</td> <td>2号炉</td> <td>破断</td> </tr> <tr> <td>17.5</td> <td>2号炉</td> <td>破断</td> <td>17.5</td> <td>2号炉</td> <td>破断</td> </tr> <tr> <td>17.6</td> <td>2号炉</td> <td>破断</td> <td>17.6</td> <td>2号炉</td> <td>破断</td> </tr> <tr> <td>17.7</td> <td>2号炉</td> <td>破断</td> <td>17.7</td> <td>2号炉</td> <td>破断</td> </tr> <tr> <td>17.8</td> <td>2号炉</td> <td>破断</td> <td>17.8</td> <td>2号炉</td> <td>破断</td> </tr> <tr> <td>17.9</td> <td>2号炉</td> <td>破断</td> <td>17.9</td> <td>2号炉</td> <td>破断</td> </tr> <tr> <td>18.0</td> <td>2号炉</td> <td>破断</td> <td>18.0</td> <td>2号炉</td> <td>破断</td> </tr> <tr> <td>18.1</td> <td>2号炉</td> <td>破断</td> <td>18.1</td> <td>2号炉</td> <td>破断</td> </tr> <tr> <td>18.2</td> <td>2号炉</td> <td>破断</td> <td>18.2</td> <td>2号炉</td> <td>破断</td> </tr> <tr> <td>18.3</td> <td>2号炉</td> <td>破断</td> <td>18.3</td> <td>2号炉</td> <td>破断</td> </tr> <tr> <td>18.4</td> <td>2号炉</td> <td>破断</td> <td>18.4</td> <td>2号炉</td> <td>破断</td> </tr> <tr> <td>18.5</td> <td>2号炉</td> <td>破断</td> <td>18.5</td> <td>2号炉</td> <td>破断</td> </tr> <tr> <td>18.6</td> <td>2号炉</td> <td>破断</td> <td>18.6</td> <td>2号炉</td> <td>破断</td> </tr> <tr> <td>18.7</td> <td>2号炉</td> <td>破断</td> <td>18.7</td> <td>2号炉</td> <td>破断</td> </tr> <tr> <td>18.8</td> <td>2号炉</td> <td>破断</td> <td>18.8</td> <td>2号炉</td> <td>破断</td> </tr> <tr> <td>18.9</td> <td>2号炉</td> <td>破断</td> <td>18.9</td> <td>2号炉</td> <td>破断</td> </tr> <tr> <td>19.0</td> <td>2号炉</td> <td>破断</td> <td>19.0</td> <td>2号炉</td> <td>破断</td> </tr> </tbody> </table> <p>②破断原因 破断原因：破断（破断原因：破断原因不明） 破断位置：2号炉（破断位置：2号炉） 破断時刻：19分（破断時刻：19分）</p> <p>③破断原因 破断原因：破断（破断原因：破断原因不明） 破断位置：2号炉（破断位置：2号炉） 破断時刻：19分（破断時刻：19分）</p>	破断時刻	破断位置	破断原因	破断時刻	破断位置	破断原因	17.1	2号炉	破断	17.1	2号炉	破断	17.2	2号炉	破断	17.2	2号炉	破断	17.3	2号炉	破断	17.3	2号炉	破断	17.4	2号炉	破断	17.4	2号炉	破断	17.5	2号炉	破断	17.5	2号炉	破断	17.6	2号炉	破断	17.6	2号炉	破断	17.7	2号炉	破断	17.7	2号炉	破断	17.8	2号炉	破断	17.8	2号炉	破断	17.9	2号炉	破断	17.9	2号炉	破断	18.0	2号炉	破断	18.0	2号炉	破断	18.1	2号炉	破断	18.1	2号炉	破断	18.2	2号炉	破断	18.2	2号炉	破断	18.3	2号炉	破断	18.3	2号炉	破断	18.4	2号炉	破断	18.4	2号炉	破断	18.5	2号炉	破断	18.5	2号炉	破断	18.6	2号炉	破断	18.6	2号炉	破断	18.7	2号炉	破断	18.7	2号炉	破断	18.8	2号炉	破断	18.8	2号炉	破断	18.9	2号炉	破断	18.9	2号炉	破断	19.0	2号炉	破断	19.0	2号炉	破断	<p>女川2号炉 想定破損による溢水影響評価結果(4/6)</p> <table border="1"> <thead> <tr> <th>破断時刻</th> <th>破断位置</th> <th>破断原因</th> <th>破断時刻</th> <th>破断位置</th> <th>破断原因</th> </tr> </thead> <tbody> <tr> <td>17.1</td> <td>2号炉</td> <td>破断</td> <td>17.1</td> <td>2号炉</td> <td>破断</td> </tr> <tr> <td>17.2</td> <td>2号炉</td> <td>破断</td> <td>17.2</td> <td>2号炉</td> <td>破断</td> </tr> <tr> <td>17.3</td> <td>2号炉</td> <td>破断</td> <td>17.3</td> <td>2号炉</td> <td>破断</td> </tr> <tr> <td>17.4</td> <td>2号炉</td> <td>破断</td> <td>17.4</td> <td>2号炉</td> <td>破断</td> </tr> <tr> <td>17.5</td> <td>2号炉</td> <td>破断</td> <td>17.5</td> <td>2号炉</td> <td>破断</td> </tr> <tr> <td>17.6</td> <td>2号炉</td> <td>破断</td> <td>17.6</td> <td>2号炉</td> <td>破断</td> </tr> <tr> <td>17.7</td> <td>2号炉</td> <td>破断</td> <td>17.7</td> <td>2号炉</td> <td>破断</td> </tr> <tr> <td>17.8</td> <td>2号炉</td> <td>破断</td> <td>17.8</td> <td>2号炉</td> <td>破断</td> </tr> <tr> <td>17.9</td> <td>2号炉</td> <td>破断</td> <td>17.9</td> <td>2号炉</td> <td>破断</td> </tr> <tr> <td>18.0</td> <td>2号炉</td> <td>破断</td> <td>18.0</td> <td>2号炉</td> <td>破断</td> </tr> <tr> <td>18.1</td> <td>2号炉</td> <td>破断</td> <td>18.1</td> <td>2号炉</td> <td>破断</td> </tr> <tr> <td>18.2</td> <td>2号炉</td> <td>破断</td> <td>18.2</td> <td>2号炉</td> <td>破断</td> </tr> <tr> <td>18.3</td> <td>2号炉</td> <td>破断</td> <td>18.3</td> <td>2号炉</td> <td>破断</td> </tr> <tr> <td>18.4</td> <td>2号炉</td> <td>破断</td> <td>18.4</td> <td>2号炉</td> <td>破断</td> </tr> <tr> <td>18.5</td> <td>2号炉</td> <td>破断</td> <td>18.5</td> <td>2号炉</td> <td>破断</td> </tr> <tr> <td>18.6</td> <td>2号炉</td> <td>破断</td> <td>18.6</td> <td>2号炉</td> <td>破断</td> </tr> <tr> <td>18.7</td> <td>2号炉</td> <td>破断</td> <td>18.7</td> <td>2号炉</td> <td>破断</td> </tr> <tr> <td>18.8</td> <td>2号炉</td> <td>破断</td> <td>18.8</td> <td>2号炉</td> <td>破断</td> </tr> <tr> <td>18.9</td> <td>2号炉</td> <td>破断</td> <td>18.9</td> <td>2号炉</td> <td>破断</td> </tr> <tr> <td>19.0</td> <td>2号炉</td> <td>破断</td> <td>19.0</td> <td>2号炉</td> <td>破断</td> </tr> </tbody> </table> <p>②破断原因 破断原因：破断（破断原因：破断原因不明） 破断位置：2号炉（破断位置：2号炉） 破断時刻：19分（破断時刻：19分）</p> <p>③破断原因 破断原因：破断（破断原因：破断原因不明） 破断位置：2号炉（破断位置：2号炉） 破断時刻：19分（破断時刻：19分）</p>	破断時刻	破断位置	破断原因	破断時刻	破断位置	破断原因	17.1	2号炉	破断	17.1	2号炉	破断	17.2	2号炉	破断	17.2	2号炉	破断	17.3	2号炉	破断	17.3	2号炉	破断	17.4	2号炉	破断	17.4	2号炉	破断	17.5	2号炉	破断	17.5	2号炉	破断	17.6	2号炉	破断	17.6	2号炉	破断	17.7	2号炉	破断	17.7	2号炉	破断	17.8	2号炉	破断	17.8	2号炉	破断	17.9	2号炉	破断	17.9	2号炉	破断	18.0	2号炉	破断	18.0	2号炉	破断	18.1	2号炉	破断	18.1	2号炉	破断	18.2	2号炉	破断	18.2	2号炉	破断	18.3	2号炉	破断	18.3	2号炉	破断	18.4	2号炉	破断	18.4	2号炉	破断	18.5	2号炉	破断	18.5	2号炉	破断	18.6	2号炉	破断	18.6	2号炉	破断	18.7	2号炉	破断	18.7	2号炉	破断	18.8	2号炉	破断	18.8	2号炉	破断	18.9	2号炉	破断	18.9	2号炉	破断	19.0	2号炉	破断	19.0	2号炉	破断	<p>泊3号炉 想定破損による溢水影響評価結果(4/6)</p> <table border="1"> <thead> <tr> <th>破断時刻</th> <th>破断位置</th> <th>破断原因</th> <th>破断時刻</th> <th>破断位置</th> <th>破断原因</th> </tr> </thead> <tbody> <tr> <td>17.1</td> <td>2号炉</td> <td>破断</td> <td>17.1</td> <td>2号炉</td> <td>破断</td> </tr> <tr> <td>17.2</td> <td>2号炉</td> <td>破断</td> <td>17.2</td> <td>2号炉</td> <td>破断</td> </tr> <tr> <td>17.3</td> <td>2号炉</td> <td>破断</td> <td>17.3</td> <td>2号炉</td> <td>破断</td> </tr> <tr> <td>17.4</td> <td>2号炉</td> <td>破断</td> <td>17.4</td> <td>2号炉</td> <td>破断</td> </tr> <tr> <td>17.5</td> <td>2号炉</td> <td>破断</td> <td>17.5</td> <td>2号炉</td> <td>破断</td> </tr> <tr> <td>17.6</td> <td>2号炉</td> <td>破断</td> <td>17.6</td> <td>2号炉</td> <td>破断</td> </tr> <tr> <td>17.7</td> <td>2号炉</td> <td>破断</td> <td>17.7</td> <td>2号炉</td> <td>破断</td> </tr> <tr> <td>17.8</td> <td>2号炉</td> <td>破断</td> <td>17.8</td> <td>2号炉</td> <td>破断</td> </tr> <tr> <td>17.9</td> <td>2号炉</td> <td>破断</td> <td>17.9</td> <td>2号炉</td> <td>破断</td> </tr> <tr> <td>18.0</td> <td>2号炉</td> <td>破断</td> <td>18.0</td> <td>2号炉</td> <td>破断</td> </tr> <tr> <td>18.1</td> <td>2号炉</td> <td>破断</td> <td>18.1</td> <td>2号炉</td> <td>破断</td> </tr> <tr> <td>18.2</td> <td>2号炉</td> <td>破断</td> <td>18.2</td> <td>2号炉</td> <td>破断</td> </tr> <tr> <td>18.3</td> <td>2号炉</td> <td>破断</td> <td>18.3</td> <td>2号炉</td> <td>破断</td> </tr> <tr> <td>18.4</td> <td>2号炉</td> <td>破断</td> <td>18.4</td> <td>2号炉</td> <td>破断</td> </tr> <tr> <td>18.5</td> <td>2号炉</td> <td>破断</td> <td>18.5</td> <td>2号炉</td> <td>破断</td> </tr> <tr> <td>18.6</td> <td>2号炉</td> <td>破断</td> <td>18.6</td> <td>2号炉</td> <td>破断</td> </tr> <tr> <td>18.7</td> <td>2号炉</td> <td>破断</td> <td>18.7</td> <td>2号炉</td> <td>破断</td> </tr> <tr> <td>18.8</td> <td>2号炉</td> <td>破断</td> <td>18.8</td> <td>2号炉</td> <td>破断</td> </tr> <tr> <td>18.9</td> <td>2号炉</td> <td>破断</td> <td>18.9</td> <td>2号炉</td> <td>破断</td> </tr> <tr> <td>19.0</td> <td>2号炉</td> <td>破断</td> <td>19.0</td> <td>2号炉</td> <td>破断</td> </tr> </tbody> </table> <p>②破断原因 破断原因：破断（破断原因：破断原因不明） 破断位置：2号炉（破断位置：2号炉） 破断時刻：19分（破断時刻：19分）</p> <p>③破断原因 破断原因：破断（破断原因：破断原因不明） 破断位置：2号炉（破断位置：2号炉） 破断時刻：19分（破断時刻：19分）</p>	破断時刻	破断位置	破断原因	破断時刻	破断位置	破断原因	17.1	2号炉	破断	17.1	2号炉	破断	17.2	2号炉	破断	17.2	2号炉	破断	17.3	2号炉	破断	17.3	2号炉	破断	17.4	2号炉	破断	17.4	2号炉	破断	17.5	2号炉	破断	17.5	2号炉	破断	17.6	2号炉	破断	17.6	2号炉	破断	17.7	2号炉	破断	17.7	2号炉	破断	17.8	2号炉	破断	17.8	2号炉	破断	17.9	2号炉	破断	17.9	2号炉	破断	18.0	2号炉	破断	18.0	2号炉	破断	18.1	2号炉	破断	18.1	2号炉	破断	18.2	2号炉	破断	18.2	2号炉	破断	18.3	2号炉	破断	18.3	2号炉	破断	18.4	2号炉	破断	18.4	2号炉	破断	18.5	2号炉	破断	18.5	2号炉	破断	18.6	2号炉	破断	18.6	2号炉	破断	18.7	2号炉	破断	18.7	2号炉	破断	18.8	2号炉	破断	18.8	2号炉	破断	18.9	2号炉	破断	18.9	2号炉	破断	19.0	2号炉	破断	19.0	2号炉	破断	<p>【大飯】 設計方針の相違 大飯はツインプラント。</p> <p>【女川】 設計方針の相違 プラント設計の違いによる評価結果の相違</p>
破断時刻	破断位置	破断原因	破断時刻	破断位置	破断原因																																																																																																																																																																																																																																																																																																																																																																																								
17.1	2号炉	破断	17.1	2号炉	破断																																																																																																																																																																																																																																																																																																																																																																																								
17.2	2号炉	破断	17.2	2号炉	破断																																																																																																																																																																																																																																																																																																																																																																																								
17.3	2号炉	破断	17.3	2号炉	破断																																																																																																																																																																																																																																																																																																																																																																																								
17.4	2号炉	破断	17.4	2号炉	破断																																																																																																																																																																																																																																																																																																																																																																																								
17.5	2号炉	破断	17.5	2号炉	破断																																																																																																																																																																																																																																																																																																																																																																																								
17.6	2号炉	破断	17.6	2号炉	破断																																																																																																																																																																																																																																																																																																																																																																																								
17.7	2号炉	破断	17.7	2号炉	破断																																																																																																																																																																																																																																																																																																																																																																																								
17.8	2号炉	破断	17.8	2号炉	破断																																																																																																																																																																																																																																																																																																																																																																																								
17.9	2号炉	破断	17.9	2号炉	破断																																																																																																																																																																																																																																																																																																																																																																																								
18.0	2号炉	破断	18.0	2号炉	破断																																																																																																																																																																																																																																																																																																																																																																																								
18.1	2号炉	破断	18.1	2号炉	破断																																																																																																																																																																																																																																																																																																																																																																																								
18.2	2号炉	破断	18.2	2号炉	破断																																																																																																																																																																																																																																																																																																																																																																																								
18.3	2号炉	破断	18.3	2号炉	破断																																																																																																																																																																																																																																																																																																																																																																																								
18.4	2号炉	破断	18.4	2号炉	破断																																																																																																																																																																																																																																																																																																																																																																																								
18.5	2号炉	破断	18.5	2号炉	破断																																																																																																																																																																																																																																																																																																																																																																																								
18.6	2号炉	破断	18.6	2号炉	破断																																																																																																																																																																																																																																																																																																																																																																																								
18.7	2号炉	破断	18.7	2号炉	破断																																																																																																																																																																																																																																																																																																																																																																																								
18.8	2号炉	破断	18.8	2号炉	破断																																																																																																																																																																																																																																																																																																																																																																																								
18.9	2号炉	破断	18.9	2号炉	破断																																																																																																																																																																																																																																																																																																																																																																																								
19.0	2号炉	破断	19.0	2号炉	破断																																																																																																																																																																																																																																																																																																																																																																																								
破断時刻	破断位置	破断原因	破断時刻	破断位置	破断原因																																																																																																																																																																																																																																																																																																																																																																																								
17.1	2号炉	破断	17.1	2号炉	破断																																																																																																																																																																																																																																																																																																																																																																																								
17.2	2号炉	破断	17.2	2号炉	破断																																																																																																																																																																																																																																																																																																																																																																																								
17.3	2号炉	破断	17.3	2号炉	破断																																																																																																																																																																																																																																																																																																																																																																																								
17.4	2号炉	破断	17.4	2号炉	破断																																																																																																																																																																																																																																																																																																																																																																																								
17.5	2号炉	破断	17.5	2号炉	破断																																																																																																																																																																																																																																																																																																																																																																																								
17.6	2号炉	破断	17.6	2号炉	破断																																																																																																																																																																																																																																																																																																																																																																																								
17.7	2号炉	破断	17.7	2号炉	破断																																																																																																																																																																																																																																																																																																																																																																																								
17.8	2号炉	破断	17.8	2号炉	破断																																																																																																																																																																																																																																																																																																																																																																																								
17.9	2号炉	破断	17.9	2号炉	破断																																																																																																																																																																																																																																																																																																																																																																																								
18.0	2号炉	破断	18.0	2号炉	破断																																																																																																																																																																																																																																																																																																																																																																																								
18.1	2号炉	破断	18.1	2号炉	破断																																																																																																																																																																																																																																																																																																																																																																																								
18.2	2号炉	破断	18.2	2号炉	破断																																																																																																																																																																																																																																																																																																																																																																																								
18.3	2号炉	破断	18.3	2号炉	破断																																																																																																																																																																																																																																																																																																																																																																																								
18.4	2号炉	破断	18.4	2号炉	破断																																																																																																																																																																																																																																																																																																																																																																																								
18.5	2号炉	破断	18.5	2号炉	破断																																																																																																																																																																																																																																																																																																																																																																																								
18.6	2号炉	破断	18.6	2号炉	破断																																																																																																																																																																																																																																																																																																																																																																																								
18.7	2号炉	破断	18.7	2号炉	破断																																																																																																																																																																																																																																																																																																																																																																																								
18.8	2号炉	破断	18.8	2号炉	破断																																																																																																																																																																																																																																																																																																																																																																																								
18.9	2号炉	破断	18.9	2号炉	破断																																																																																																																																																																																																																																																																																																																																																																																								
19.0	2号炉	破断	19.0	2号炉	破断																																																																																																																																																																																																																																																																																																																																																																																								
破断時刻	破断位置	破断原因	破断時刻	破断位置	破断原因																																																																																																																																																																																																																																																																																																																																																																																								
17.1	2号炉	破断	17.1	2号炉	破断																																																																																																																																																																																																																																																																																																																																																																																								
17.2	2号炉	破断	17.2	2号炉	破断																																																																																																																																																																																																																																																																																																																																																																																								
17.3	2号炉	破断	17.3	2号炉	破断																																																																																																																																																																																																																																																																																																																																																																																								
17.4	2号炉	破断	17.4	2号炉	破断																																																																																																																																																																																																																																																																																																																																																																																								
17.5	2号炉	破断	17.5	2号炉	破断																																																																																																																																																																																																																																																																																																																																																																																								
17.6	2号炉	破断	17.6	2号炉	破断																																																																																																																																																																																																																																																																																																																																																																																								
17.7	2号炉	破断	17.7	2号炉	破断																																																																																																																																																																																																																																																																																																																																																																																								
17.8	2号炉	破断	17.8	2号炉	破断																																																																																																																																																																																																																																																																																																																																																																																								
17.9	2号炉	破断	17.9	2号炉	破断																																																																																																																																																																																																																																																																																																																																																																																								
18.0	2号炉	破断	18.0	2号炉	破断																																																																																																																																																																																																																																																																																																																																																																																								
18.1	2号炉	破断	18.1	2号炉	破断																																																																																																																																																																																																																																																																																																																																																																																								
18.2	2号炉	破断	18.2	2号炉	破断																																																																																																																																																																																																																																																																																																																																																																																								
18.3	2号炉	破断	18.3	2号炉	破断																																																																																																																																																																																																																																																																																																																																																																																								
18.4	2号炉	破断	18.4	2号炉	破断																																																																																																																																																																																																																																																																																																																																																																																								
18.5	2号炉	破断	18.5	2号炉	破断																																																																																																																																																																																																																																																																																																																																																																																								
18.6	2号炉	破断	18.6	2号炉	破断																																																																																																																																																																																																																																																																																																																																																																																								
18.7	2号炉	破断	18.7	2号炉	破断																																																																																																																																																																																																																																																																																																																																																																																								
18.8	2号炉	破断	18.8	2号炉	破断																																																																																																																																																																																																																																																																																																																																																																																								
18.9	2号炉	破断	18.9	2号炉	破断																																																																																																																																																																																																																																																																																																																																																																																								
19.0	2号炉	破断	19.0	2号炉	破断																																																																																																																																																																																																																																																																																																																																																																																								

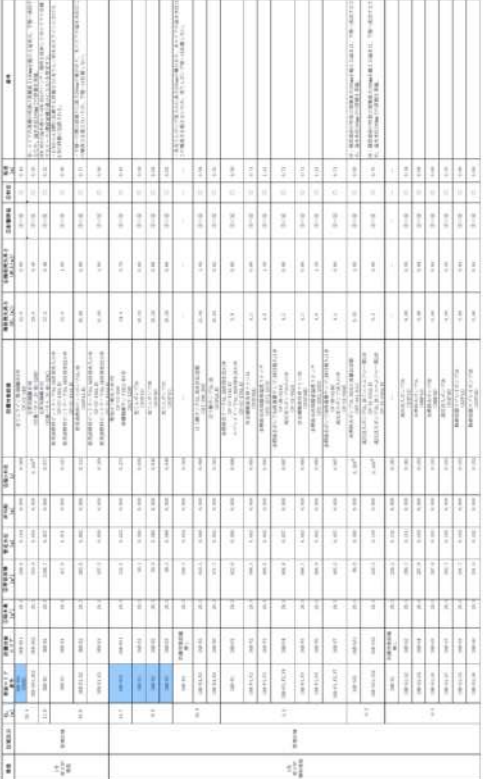
赤字：設備、運用又は体制の相違（設計方針の相違）
 青字：記載箇所又は記載内容の相違（記載方針の相違）
 緑字：記載表現、設備名称の相違（実質的な相違なし）

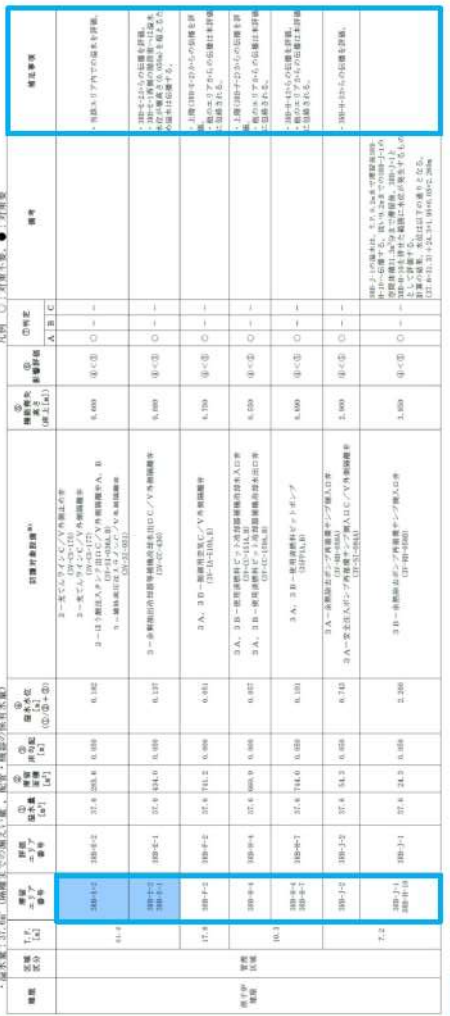
大飯発電所3/4号炉	女川原子力発電所2号炉	泊発電所3号炉	相違理由
<p>【参考】 伊方発電所3号炉</p> <p style="text-align: right;">添付資料 15</p>  <p>添付資料15</p>	<p>女川原子力発電所2号炉</p>  <p>添付資料17</p>	<p>泊発電所3号炉</p> <p>【再掲】 想定破損による没水影響評価結果</p> <p>表1 没水影響評価結果整理表(想定破損)(1/7)</p>  <p>添付資料17</p>	<p>相違理由</p> <p>【女川】 設計方針の相違 プラント設計の違いによる評価結果の相違</p> <p>【参考】【伊方】 記載方針の相違 泊と同様のまとめ方をしている先行PWRとしては、伊方、川内、玄海があり、大飯の評価結果の後(9-別添1-添17-25)に伊方の評価結果を掲載する。</p>

赤字：設備、運用又は体制の相違（設計方針の相違）
 青字：記載箇所又は記載内容の相違（記載方針の相違）
 緑字：記載表現、設備名称の相違（実質的な相違なし）

大飯発電所3/4号炉	女川原子力発電所2号炉	泊発電所3号炉	相違理由																																														
	<div style="border: 2px solid red; padding: 5px;"> <p>設計種別： 標準 標準 基本設計年度： 昭和三十九年 設計者： 日電研</p> <table border="1" style="width: 100%; border-collapse: collapse; text-align: center;"> <thead> <tr> <th colspan="2" rowspan="2">緊急停止設備</th> <th colspan="2">緊急停止設備 停止方法</th> <th colspan="2">緊急停止設備 停止時間</th> <th colspan="2">緊急停止設備 停止場所</th> <th colspan="2">緊急停止設備 停止条件</th> <th colspan="2">緊急停止設備 停止結果</th> </tr> <tr> <th>緊急停止設備 停止方法</th> <th>緊急停止設備 停止時間</th> <th>緊急停止設備 停止場所</th> <th>緊急停止設備 停止時間</th> <th>緊急停止設備 停止場所</th> <th>緊急停止設備 停止条件</th> <th>緊急停止設備 停止結果</th> <th>緊急停止設備 停止条件</th> <th>緊急停止設備 停止結果</th> <th>緊急停止設備 停止結果</th> </tr> </thead> <tbody> <tr> <td>緊急停止設備</td> <td>○</td> <td>緊急停止設備 停止方法</td> <td>緊急停止設備 停止時間</td> <td>緊急停止設備 停止場所</td> <td>緊急停止設備 停止時間</td> <td>緊急停止設備 停止場所</td> <td>緊急停止設備 停止条件</td> <td>緊急停止設備 停止結果</td> <td>緊急停止設備 停止条件</td> <td>緊急停止設備 停止結果</td> <td>緊急停止設備 停止結果</td> </tr> <tr> <td>緊急停止設備</td> <td>○</td> <td>緊急停止設備 停止方法</td> <td>緊急停止設備 停止時間</td> <td>緊急停止設備 停止場所</td> <td>緊急停止設備 停止時間</td> <td>緊急停止設備 停止場所</td> <td>緊急停止設備 停止条件</td> <td>緊急停止設備 停止結果</td> <td>緊急停止設備 停止条件</td> <td>緊急停止設備 停止結果</td> <td>緊急停止設備 停止結果</td> </tr> </tbody> </table> </div>	緊急停止設備		緊急停止設備 停止方法		緊急停止設備 停止時間		緊急停止設備 停止場所		緊急停止設備 停止条件		緊急停止設備 停止結果		緊急停止設備 停止方法	緊急停止設備 停止時間	緊急停止設備 停止場所	緊急停止設備 停止時間	緊急停止設備 停止場所	緊急停止設備 停止条件	緊急停止設備 停止結果	緊急停止設備 停止条件	緊急停止設備 停止結果	緊急停止設備 停止結果	緊急停止設備	○	緊急停止設備 停止方法	緊急停止設備 停止時間	緊急停止設備 停止場所	緊急停止設備 停止時間	緊急停止設備 停止場所	緊急停止設備 停止条件	緊急停止設備 停止結果	緊急停止設備 停止条件	緊急停止設備 停止結果	緊急停止設備 停止結果	緊急停止設備	○	緊急停止設備 停止方法	緊急停止設備 停止時間	緊急停止設備 停止場所	緊急停止設備 停止時間	緊急停止設備 停止場所	緊急停止設備 停止条件	緊急停止設備 停止結果	緊急停止設備 停止条件	緊急停止設備 停止結果	緊急停止設備 停止結果		<p>【女川】 設計方針の相違 プラント設計の違いによる評価結果の相違</p>
緊急停止設備				緊急停止設備 停止方法		緊急停止設備 停止時間		緊急停止設備 停止場所		緊急停止設備 停止条件		緊急停止設備 停止結果																																					
		緊急停止設備 停止方法	緊急停止設備 停止時間	緊急停止設備 停止場所	緊急停止設備 停止時間	緊急停止設備 停止場所	緊急停止設備 停止条件	緊急停止設備 停止結果	緊急停止設備 停止条件	緊急停止設備 停止結果	緊急停止設備 停止結果																																						
緊急停止設備	○	緊急停止設備 停止方法	緊急停止設備 停止時間	緊急停止設備 停止場所	緊急停止設備 停止時間	緊急停止設備 停止場所	緊急停止設備 停止条件	緊急停止設備 停止結果	緊急停止設備 停止条件	緊急停止設備 停止結果	緊急停止設備 停止結果																																						
緊急停止設備	○	緊急停止設備 停止方法	緊急停止設備 停止時間	緊急停止設備 停止場所	緊急停止設備 停止時間	緊急停止設備 停止場所	緊急停止設備 停止条件	緊急停止設備 停止結果	緊急停止設備 停止条件	緊急停止設備 停止結果	緊急停止設備 停止結果																																						

赤字：設備、運用又は体制の相違（設計方針の相違）
 青字：記載箇所又は記載内容の相違（記載方針の相違）
 緑字：記載表現、設備名称の相違（実質的な相違なし）

大飯発電所3/4号炉	女川原子力発電所2号炉	泊発電所3号炉	相違理由																																																																																																																																																												
	<div style="border: 2px solid red; padding: 5px;"> <table border="1" style="width: 100%; border-collapse: collapse;"> <tr> <td colspan="2" style="text-align: center;">原子炉設備</td> <td colspan="2" style="text-align: center;">原子炉設備</td> <td colspan="2" style="text-align: center;">原子炉設備</td> <td colspan="2" style="text-align: center;">原子炉設備</td> <td colspan="2" style="text-align: center;">原子炉設備</td> <td colspan="2" style="text-align: center;">原子炉設備</td> </tr> <tr> <td colspan="2" style="text-align: center;">緊急停止機能</td> <td colspan="2" style="text-align: center;">緊急停止機能</td> <td colspan="2" style="text-align: center;">緊急停止機能</td> <td colspan="2" style="text-align: center;">緊急停止機能</td> <td colspan="2" style="text-align: center;">緊急停止機能</td> <td colspan="2" style="text-align: center;">緊急停止機能</td> </tr> <tr> <td style="text-align: center;">○</td> <td style="text-align: center;">○</td> <td style="text-align: center;">○</td> <td style="text-align: center;">○</td> <td style="text-align: center;">○</td> <td style="text-align: center;">○</td> <td style="text-align: center;">○</td> <td style="text-align: center;">○</td> <td style="text-align: center;">○</td> <td style="text-align: center;">○</td> <td style="text-align: center;">○</td> <td style="text-align: center;">○</td> </tr> <tr> <td colspan="2" style="text-align: center;">水圧制御システム</td> <td colspan="2" style="text-align: center;">水圧制御システム</td> <td colspan="2" style="text-align: center;">水圧制御システム</td> <td colspan="2" style="text-align: center;">水圧制御システム</td> <td colspan="2" style="text-align: center;">水圧制御システム</td> <td colspan="2" style="text-align: center;">水圧制御システム</td> </tr> <tr> <td style="text-align: center;">○</td> <td style="text-align: center;">○</td> <td style="text-align: center;">○</td> <td style="text-align: center;">○</td> <td style="text-align: center;">○</td> <td style="text-align: center;">○</td> <td style="text-align: center;">○</td> <td style="text-align: center;">○</td> <td style="text-align: center;">○</td> <td style="text-align: center;">○</td> <td style="text-align: center;">○</td> <td style="text-align: center;">○</td> </tr> <tr> <td colspan="2" style="text-align: center;">A系(1機)</td> <td colspan="2" style="text-align: center;">A系(1機)</td> <td colspan="2" style="text-align: center;">A系(1機)</td> <td colspan="2" style="text-align: center;">A系(1機)</td> <td colspan="2" style="text-align: center;">A系(1機)</td> <td colspan="2" style="text-align: center;">A系(1機)</td> </tr> <tr> <td style="text-align: center;">○</td> <td style="text-align: center;">○</td> <td style="text-align: center;">○</td> <td style="text-align: center;">○</td> <td style="text-align: center;">○</td> <td style="text-align: center;">○</td> <td style="text-align: center;">○</td> <td style="text-align: center;">○</td> <td style="text-align: center;">○</td> <td style="text-align: center;">○</td> <td style="text-align: center;">○</td> <td style="text-align: center;">○</td> </tr> <tr> <td colspan="2" style="text-align: center;">B系(1機)</td> <td colspan="2" style="text-align: center;">B系(1機)</td> <td colspan="2" style="text-align: center;">B系(1機)</td> <td colspan="2" style="text-align: center;">B系(1機)</td> <td colspan="2" style="text-align: center;">B系(1機)</td> <td colspan="2" style="text-align: center;">B系(1機)</td> </tr> <tr> <td style="text-align: center;">○</td> <td style="text-align: center;">○</td> <td style="text-align: center;">○</td> <td style="text-align: center;">○</td> <td style="text-align: center;">○</td> <td style="text-align: center;">○</td> <td style="text-align: center;">○</td> <td style="text-align: center;">○</td> <td style="text-align: center;">○</td> <td style="text-align: center;">○</td> <td style="text-align: center;">○</td> <td style="text-align: center;">○</td> </tr> <tr> <td colspan="2" style="text-align: center;">C系(1機)</td> <td colspan="2" style="text-align: center;">C系(1機)</td> <td colspan="2" style="text-align: center;">C系(1機)</td> <td colspan="2" style="text-align: center;">C系(1機)</td> <td colspan="2" style="text-align: center;">C系(1機)</td> <td colspan="2" style="text-align: center;">C系(1機)</td> </tr> <tr> <td style="text-align: center;">○</td> <td style="text-align: center;">○</td> <td style="text-align: center;">○</td> <td style="text-align: center;">○</td> <td style="text-align: center;">○</td> <td style="text-align: center;">○</td> <td style="text-align: center;">○</td> <td style="text-align: center;">○</td> <td style="text-align: center;">○</td> <td style="text-align: center;">○</td> <td style="text-align: center;">○</td> <td style="text-align: center;">○</td> </tr> <tr> <td colspan="2" style="text-align: center;">D系(1機)</td> <td colspan="2" style="text-align: center;">D系(1機)</td> <td colspan="2" style="text-align: center;">D系(1機)</td> <td colspan="2" style="text-align: center;">D系(1機)</td> <td colspan="2" style="text-align: center;">D系(1機)</td> <td colspan="2" style="text-align: center;">D系(1機)</td> </tr> <tr> <td style="text-align: center;">○</td> <td style="text-align: center;">○</td> <td style="text-align: center;">○</td> <td style="text-align: center;">○</td> <td style="text-align: center;">○</td> <td style="text-align: center;">○</td> <td style="text-align: center;">○</td> <td style="text-align: center;">○</td> <td style="text-align: center;">○</td> <td style="text-align: center;">○</td> <td style="text-align: center;">○</td> <td style="text-align: center;">○</td> </tr> </table> </div>	原子炉設備		原子炉設備		原子炉設備		原子炉設備		原子炉設備		原子炉設備		緊急停止機能		緊急停止機能		緊急停止機能		緊急停止機能		緊急停止機能		緊急停止機能		○	○	○	○	○	○	○	○	○	○	○	○	水圧制御システム		水圧制御システム		水圧制御システム		水圧制御システム		水圧制御システム		水圧制御システム		○	○	○	○	○	○	○	○	○	○	○	○	A系(1機)		A系(1機)		A系(1機)		A系(1機)		A系(1機)		A系(1機)		○	○	○	○	○	○	○	○	○	○	○	○	B系(1機)		B系(1機)		B系(1機)		B系(1機)		B系(1機)		B系(1機)		○	○	○	○	○	○	○	○	○	○	○	○	C系(1機)		C系(1機)		C系(1機)		C系(1機)		C系(1機)		C系(1機)		○	○	○	○	○	○	○	○	○	○	○	○	D系(1機)		D系(1機)		D系(1機)		D系(1機)		D系(1機)		D系(1機)		○	○	○	○	○	○	○	○	○	○	○	○		<p>【女川】 設計方針の相違 プラント設計の違いによる評価結果の相違</p>
原子炉設備		原子炉設備		原子炉設備		原子炉設備		原子炉設備		原子炉設備																																																																																																																																																					
緊急停止機能		緊急停止機能		緊急停止機能		緊急停止機能		緊急停止機能		緊急停止機能																																																																																																																																																					
○	○	○	○	○	○	○	○	○	○	○	○																																																																																																																																																				
水圧制御システム		水圧制御システム		水圧制御システム		水圧制御システム		水圧制御システム		水圧制御システム																																																																																																																																																					
○	○	○	○	○	○	○	○	○	○	○	○																																																																																																																																																				
A系(1機)		A系(1機)		A系(1機)		A系(1機)		A系(1機)		A系(1機)																																																																																																																																																					
○	○	○	○	○	○	○	○	○	○	○	○																																																																																																																																																				
B系(1機)		B系(1機)		B系(1機)		B系(1機)		B系(1機)		B系(1機)																																																																																																																																																					
○	○	○	○	○	○	○	○	○	○	○	○																																																																																																																																																				
C系(1機)		C系(1機)		C系(1機)		C系(1機)		C系(1機)		C系(1機)																																																																																																																																																					
○	○	○	○	○	○	○	○	○	○	○	○																																																																																																																																																				
D系(1機)		D系(1機)		D系(1機)		D系(1機)		D系(1機)		D系(1機)																																																																																																																																																					
○	○	○	○	○	○	○	○	○	○	○	○																																																																																																																																																				

赤字：設備、運用又は体制の相違（設計方針の相違）
 青字：記載箇所又は記載内容の相違（記載方針の相違）
 緑字：記載表現、設備名称の相違（実質的な相違なし）

大飯発電所3/4号炉	女川原子力発電所2号炉	泊発電所3号炉	相違理由
<p>大飯発電所3/4号炉</p> <p>表1 浸水影響評価結果整理表(想定破損)(5/7)</p>	<p>表1 浸水影響評価結果整理表(想定破損)(5/7)</p> <p>表2 浸水影響評価結果整理表(想定破損)(5/7)</p>	<p>表1 浸水影響評価結果整理表(想定破損)(5/7)</p>	<p>【女川】 設計方針の相違 プラント設計の違いによる評価結果の相違</p> <p>【参考】【伊方】 記載方針の相違 泊と同様のまとめ方をしている先行PWRとしては、伊方、川内、玄海があり、大飯の評価結果の後(9-別添1-添17-25)に伊方の評価結果を掲載する。</p>

赤字：設備、運用又は体制の相違（設計方針の相違）
 青字：記載箇所又は記載内容の相違（記載方針の相違）
 緑字：記載表現、設備名称の相違（実質的な相違なし）

大飯発電所3/4号炉	女川原子力発電所2号炉	泊発電所3号炉	相違理由																																																																																																																																																																																																																																																																																																																																																																																																																																																																																																																																																																																																																																																																																																																																																																																																																																																																																																																																																																																																																																																												
	<div style="border: 2px solid red; padding: 5px;"> <p>設計種別 標準仕様</p> <p>設計者 株式会社日立製作所 設計者番号 017-14</p> <p>製本番号 H27003</p> <table border="1" style="width: 100%; border-collapse: collapse; text-align: center;"> <thead> <tr> <th colspan="2">標準仕様</th> <th colspan="2">大飯原子力発電所 (設計仕様)</th> <th colspan="2">女川原子力発電所 (設計仕様)</th> <th colspan="2">泊発電所3号炉 (設計仕様)</th> <th colspan="2">相違理由</th> </tr> <tr> <th>項目</th> <th>標準仕様</th> <th>大飯</th> <th>女川</th> <th>泊</th> <th>大飯</th> <th>女川</th> <th>泊</th> <th>相違</th> <th>理由</th> </tr> </thead> <tbody> <tr> <td>設計1</td> <td>○</td> <td>○</td> <td>○</td> <td>○</td> <td>○</td> <td>○</td> <td>○</td> <td></td> <td></td> </tr> <tr> <td>設計2</td> <td>○</td> <td>○</td> <td>○</td> <td>○</td> <td>○</td> <td>○</td> <td>○</td> <td></td> <td></td> </tr> <tr> <td>設計3</td> <td>○</td> <td>○</td> <td>○</td> <td>○</td> <td>○</td> <td>○</td> <td>○</td> <td></td> <td></td> </tr> <tr> <td>設計4</td> <td>○</td> <td>○</td> <td>○</td> <td>○</td> <td>○</td> <td>○</td> <td>○</td> <td></td> <td></td> </tr> <tr> <td>設計5</td> <td>○</td> <td>○</td> <td>○</td> <td>○</td> <td>○</td> <td>○</td> <td>○</td> <td></td> <td></td> </tr> <tr> <td>設計6</td> <td>○</td> <td>○</td> <td>○</td> <td>○</td> <td>○</td> <td>○</td> <td>○</td> <td></td> <td></td> </tr> <tr> <td>設計7</td> <td>○</td> <td>○</td> <td>○</td> <td>○</td> <td>○</td> <td>○</td> <td>○</td> <td></td> <td></td> </tr> <tr> <td>設計8</td> <td>○</td> <td>○</td> <td>○</td> <td>○</td> <td>○</td> <td>○</td> <td>○</td> <td></td> <td></td> </tr> <tr> <td>設計9</td> <td>○</td> <td>○</td> <td>○</td> <td>○</td> <td>○</td> <td>○</td> <td>○</td> <td></td> <td></td> </tr> <tr> <td>設計10</td> <td>○</td> <td>○</td> <td>○</td> <td>○</td> <td>○</td> <td>○</td> <td>○</td> <td></td> <td></td> </tr> <tr> <td>設計11</td> <td>○</td> <td>○</td> <td>○</td> <td>○</td> <td>○</td> <td>○</td> <td>○</td> <td></td> <td></td> </tr> <tr> <td>設計12</td> <td>○</td> <td>○</td> <td>○</td> <td>○</td> <td>○</td> <td>○</td> <td>○</td> <td></td> <td></td> </tr> <tr> <td>設計13</td> <td>○</td> <td>○</td> <td>○</td> <td>○</td> <td>○</td> <td>○</td> <td>○</td> <td></td> <td></td> </tr> <tr> <td>設計14</td> <td>○</td> <td>○</td> <td>○</td> <td>○</td> <td>○</td> <td>○</td> <td>○</td> <td></td> <td></td> </tr> <tr> <td>設計15</td> <td>○</td> <td>○</td> <td>○</td> <td>○</td> <td>○</td> <td>○</td> <td>○</td> <td></td> <td></td> </tr> <tr> <td>設計16</td> <td>○</td> <td>○</td> <td>○</td> <td>○</td> <td>○</td> <td>○</td> <td>○</td> <td></td> <td></td> </tr> <tr> <td>設計17</td> <td>○</td> <td>○</td> <td>○</td> <td>○</td> <td>○</td> <td>○</td> <td>○</td> <td></td> <td></td> </tr> <tr> <td>設計18</td> <td>○</td> <td>○</td> <td>○</td> <td>○</td> <td>○</td> <td>○</td> <td>○</td> <td></td> <td></td> </tr> <tr> <td>設計19</td> <td>○</td> <td>○</td> <td>○</td> <td>○</td> <td>○</td> <td>○</td> <td>○</td> <td></td> <td></td> </tr> <tr> <td>設計20</td> <td>○</td> <td>○</td> <td>○</td> <td>○</td> <td>○</td> <td>○</td> <td>○</td> <td></td> <td></td> </tr> <tr> <td>設計21</td> <td>○</td> <td>○</td> <td>○</td> <td>○</td> <td>○</td> <td>○</td> <td>○</td> <td></td> <td></td> </tr> <tr> <td>設計22</td> <td>○</td> <td>○</td> <td>○</td> <td>○</td> <td>○</td> <td>○</td> <td>○</td> <td></td> <td></td> </tr> <tr> <td>設計23</td> <td>○</td> <td>○</td> <td>○</td> <td>○</td> <td>○</td> <td>○</td> <td>○</td> <td></td> <td></td> </tr> <tr> <td>設計24</td> <td>○</td> <td>○</td> <td>○</td> <td>○</td> <td>○</td> <td>○</td> <td>○</td> <td></td> <td></td> </tr> <tr> <td>設計25</td> <td>○</td> <td>○</td> <td>○</td> <td>○</td> <td>○</td> <td>○</td> <td>○</td> <td></td> <td></td> </tr> <tr> <td>設計26</td> <td>○</td> <td>○</td> <td>○</td> <td>○</td> <td>○</td> <td>○</td> <td>○</td> <td></td> <td></td> </tr> <tr> <td>設計27</td> <td>○</td> <td>○</td> <td>○</td> <td>○</td> <td>○</td> <td>○</td> <td>○</td> <td></td> <td></td> </tr> <tr> <td>設計28</td> <td>○</td> <td>○</td> <td>○</td> <td>○</td> <td>○</td> <td>○</td> <td>○</td> <td></td> <td></td> </tr> <tr> <td>設計29</td> <td>○</td> <td>○</td> <td>○</td> <td>○</td> <td>○</td> <td>○</td> <td>○</td> <td></td> <td></td> </tr> <tr> <td>設計30</td> <td>○</td> <td>○</td> <td>○</td> <td>○</td> <td>○</td> <td>○</td> <td>○</td> <td></td> <td></td> </tr> <tr> <td>設計31</td> <td>○</td> <td>○</td> <td>○</td> <td>○</td> <td>○</td> <td>○</td> <td>○</td> <td></td> <td></td> </tr> <tr> <td>設計32</td> <td>○</td> <td>○</td> <td>○</td> <td>○</td> <td>○</td> <td>○</td> <td>○</td> <td></td> <td></td> </tr> <tr> <td>設計33</td> <td>○</td> <td>○</td> <td>○</td> <td>○</td> <td>○</td> <td>○</td> <td>○</td> <td></td> <td></td> </tr> <tr> <td>設計34</td> <td>○</td> <td>○</td> <td>○</td> <td>○</td> <td>○</td> <td>○</td> <td>○</td> <td></td> <td></td> </tr> <tr> <td>設計35</td> <td>○</td> <td>○</td> <td>○</td> <td>○</td> <td>○</td> <td>○</td> <td>○</td> <td></td> <td></td> </tr> <tr> <td>設計36</td> <td>○</td> <td>○</td> <td>○</td> <td>○</td> <td>○</td> <td>○</td> <td>○</td> <td></td> <td></td> </tr> <tr> <td>設計37</td> <td>○</td> <td>○</td> <td>○</td> <td>○</td> <td>○</td> <td>○</td> <td>○</td> <td></td> <td></td> </tr> <tr> <td>設計38</td> <td>○</td> <td>○</td> <td>○</td> <td>○</td> <td>○</td> <td>○</td> <td>○</td> <td></td> <td></td> </tr> <tr> <td>設計39</td> <td>○</td> <td>○</td> <td>○</td> <td>○</td> <td>○</td> <td>○</td> <td>○</td> <td></td> <td></td> </tr> <tr> <td>設計40</td> <td>○</td> <td>○</td> <td>○</td> <td>○</td> <td>○</td> <td>○</td> <td>○</td> <td></td> <td></td> </tr> <tr> <td>設計41</td> <td>○</td> <td>○</td> <td>○</td> <td>○</td> <td>○</td> <td>○</td> <td>○</td> <td></td> <td></td> </tr> <tr> <td>設計42</td> <td>○</td> <td>○</td> <td>○</td> <td>○</td> <td>○</td> <td>○</td> <td>○</td> <td></td> <td></td> </tr> <tr> <td>設計43</td> <td>○</td> <td>○</td> <td>○</td> <td>○</td> <td>○</td> <td>○</td> <td>○</td> <td></td> <td></td> </tr> <tr> <td>設計44</td> <td>○</td> <td>○</td> <td>○</td> <td>○</td> <td>○</td> <td>○</td> <td>○</td> <td></td> <td></td> </tr> <tr> <td>設計45</td> <td>○</td> <td>○</td> <td>○</td> <td>○</td> <td>○</td> <td>○</td> <td>○</td> <td></td> <td></td> </tr> <tr> <td>設計46</td> <td>○</td> <td>○</td> <td>○</td> <td>○</td> <td>○</td> <td>○</td> <td>○</td> <td></td> <td></td> </tr> <tr> <td>設計47</td> <td>○</td> <td>○</td> <td>○</td> <td>○</td> <td>○</td> <td>○</td> <td>○</td> <td></td> <td></td> </tr> <tr> <td>設計48</td> <td>○</td> <td>○</td> <td>○</td> <td>○</td> <td>○</td> <td>○</td> <td>○</td> <td></td> <td></td> </tr> <tr> <td>設計49</td> <td>○</td> <td>○</td> <td>○</td> <td>○</td> <td>○</td> <td>○</td> <td>○</td> <td></td> <td></td> </tr> <tr> <td>設計50</td> <td>○</td> <td>○</td> <td>○</td> <td>○</td> <td>○</td> <td>○</td> <td>○</td> <td></td> <td></td> </tr> <tr> <td>設計51</td> <td>○</td> <td>○</td> <td>○</td> <td>○</td> <td>○</td> <td>○</td> <td>○</td> <td></td> <td></td> </tr> <tr> <td>設計52</td> <td>○</td> <td>○</td> <td>○</td> <td>○</td> <td>○</td> <td>○</td> <td>○</td> <td></td> <td></td> </tr> <tr> <td>設計53</td> <td>○</td> <td>○</td> <td>○</td> <td>○</td> <td>○</td> <td>○</td> <td>○</td> <td></td> <td></td> </tr> <tr> <td>設計54</td> <td>○</td> <td>○</td> <td>○</td> <td>○</td> <td>○</td> <td>○</td> <td>○</td> <td></td> <td></td> </tr> <tr> <td>設計55</td> <td>○</td> <td>○</td> <td>○</td> <td>○</td> <td>○</td> <td>○</td> <td>○</td> <td></td> <td></td> </tr> <tr> <td>設計56</td> <td>○</td> <td>○</td> <td>○</td> <td>○</td> <td>○</td> <td>○</td> <td>○</td> <td></td> <td></td> </tr> <tr> <td>設計57</td> <td>○</td> <td>○</td> <td>○</td> <td>○</td> <td>○</td> <td>○</td> <td>○</td> <td></td> <td></td> </tr> <tr> <td>設計58</td> <td>○</td> <td>○</td> <td>○</td> <td>○</td> <td>○</td> <td>○</td> <td>○</td> <td></td> <td></td> </tr> <tr> <td>設計59</td> <td>○</td> <td>○</td> <td>○</td> <td>○</td> <td>○</td> <td>○</td> <td>○</td> <td></td> <td></td> </tr> <tr> <td>設計60</td> <td>○</td> <td>○</td> <td>○</td> <td>○</td> <td>○</td> <td>○</td> <td>○</td> <td></td> <td></td> </tr> <tr> <td>設計61</td> <td>○</td> <td>○</td> <td>○</td> <td>○</td> <td>○</td> <td>○</td> <td>○</td> <td></td> <td></td> </tr> <tr> <td>設計62</td> <td>○</td> <td>○</td> <td>○</td> <td>○</td> <td>○</td> <td>○</td> <td>○</td> <td></td> <td></td> </tr> <tr> <td>設計63</td> <td>○</td> <td>○</td> <td>○</td> <td>○</td> <td>○</td> <td>○</td> <td>○</td> <td></td> <td></td> </tr> <tr> <td>設計64</td> <td>○</td> <td>○</td> <td>○</td> <td>○</td> <td>○</td> <td>○</td> <td>○</td> <td></td> <td></td> </tr> <tr> <td>設計65</td> <td>○</td> <td>○</td> <td>○</td> <td>○</td> <td>○</td> <td>○</td> <td>○</td> <td></td> <td></td> </tr> <tr> <td>設計66</td> <td>○</td> <td>○</td> <td>○</td> <td>○</td> <td>○</td> <td>○</td> <td>○</td> <td></td> <td></td> </tr> <tr> <td>設計67</td> <td>○</td> <td>○</td> <td>○</td> <td>○</td> <td>○</td> <td>○</td> <td>○</td> <td></td> <td></td> </tr> <tr> <td>設計68</td> <td>○</td> <td>○</td> <td>○</td> <td>○</td> <td>○</td> <td>○</td> <td>○</td> <td></td> <td></td> </tr> <tr> <td>設計69</td> <td>○</td> <td>○</td> <td>○</td> <td>○</td> <td>○</td> <td>○</td> <td>○</td> <td></td> <td></td> </tr> <tr> <td>設計70</td> <td>○</td> <td>○</td> <td>○</td> <td>○</td> <td>○</td> <td>○</td> <td>○</td> <td></td> <td></td> </tr> <tr> <td>設計71</td> <td>○</td> <td>○</td> <td>○</td> <td>○</td> <td>○</td> <td>○</td> <td>○</td> <td></td> <td></td> </tr> <tr> <td>設計72</td> <td>○</td> <td>○</td> <td>○</td> <td>○</td> <td>○</td> <td>○</td> <td>○</td> <td></td> <td></td> </tr> <tr> <td>設計73</td> <td>○</td> <td>○</td> <td>○</td> <td>○</td> <td>○</td> <td>○</td> <td>○</td> <td></td> <td></td> </tr> <tr> <td>設計74</td> <td>○</td> <td>○</td> <td>○</td> <td>○</td> <td>○</td> <td>○</td> <td>○</td> <td></td> <td></td> </tr> <tr> <td>設計75</td> <td>○</td> <td>○</td> <td>○</td> <td>○</td> <td>○</td> <td>○</td> <td>○</td> <td></td> <td></td> </tr> <tr> <td>設計76</td> <td>○</td> <td>○</td> <td>○</td> <td>○</td> <td>○</td> <td>○</td> <td>○</td> <td></td> <td></td> </tr> <tr> <td>設計77</td> <td>○</td> <td>○</td> <td>○</td> <td>○</td> <td>○</td> <td>○</td> <td>○</td> <td></td> <td></td> </tr> <tr> <td>設計78</td> <td>○</td> <td>○</td> <td>○</td> <td>○</td> <td>○</td> <td>○</td> <td>○</td> <td></td> <td></td> </tr> <tr> <td>設計79</td> <td>○</td> <td>○</td> <td>○</td> <td>○</td> <td>○</td> <td>○</td> <td>○</td> <td></td> <td></td> </tr> <tr> <td>設計80</td> <td>○</td> <td>○</td> <td>○</td> <td>○</td> <td>○</td> <td>○</td> <td>○</td> <td></td> <td></td> </tr> <tr> <td>設計81</td> <td>○</td> <td>○</td> <td>○</td> <td>○</td> <td>○</td> <td>○</td> <td>○</td> <td></td> <td></td> </tr> <tr> <td>設計82</td> <td>○</td> <td>○</td> <td>○</td> <td>○</td> <td>○</td> <td>○</td> <td>○</td> <td></td> <td></td> </tr> <tr> <td>設計83</td> <td>○</td> <td>○</td> <td>○</td> <td>○</td> <td>○</td> <td>○</td> <td>○</td> <td></td> <td></td> </tr> <tr> <td>設計84</td> <td>○</td> <td>○</td> <td>○</td> <td>○</td> <td>○</td> <td>○</td> <td>○</td> <td></td> <td></td> </tr> <tr> <td>設計85</td> <td>○</td> <td>○</td> <td>○</td> <td>○</td> <td>○</td> <td>○</td> <td>○</td> <td></td> <td></td> </tr> <tr> <td>設計86</td> <td>○</td> <td>○</td> <td>○</td> <td>○</td> <td>○</td> <td>○</td> <td>○</td> <td></td> <td></td> </tr> <tr> <td>設計87</td> <td>○</td> <td>○</td> <td>○</td> <td>○</td> <td>○</td> <td>○</td> <td>○</td> <td></td> <td></td> </tr> <tr> <td>設計88</td> <td>○</td> <td>○</td> <td>○</td> <td>○</td> <td>○</td> <td>○</td> <td>○</td> <td></td> <td></td> </tr> <tr> <td>設計89</td> <td>○</td> <td>○</td> <td>○</td> <td>○</td> <td>○</td> <td>○</td> <td>○</td> <td></td> <td></td> </tr> <tr> <td>設計90</td> <td>○</td> <td>○</td> <td>○</td> <td>○</td> <td>○</td> <td>○</td> <td>○</td> <td></td> <td></td> </tr> <tr> <td>設計91</td> <td>○</td> <td>○</td> <td>○</td> <td>○</td> <td>○</td> <td>○</td> <td>○</td> <td></td> <td></td> </tr> <tr> <td>設計92</td> <td>○</td> <td>○</td> <td>○</td> <td>○</td> <td>○</td> <td>○</td> <td>○</td> <td></td> <td></td> </tr> <tr> <td>設計93</td> <td>○</td> <td>○</td> <td>○</td> <td>○</td> <td>○</td> <td>○</td> <td>○</td> <td></td> <td></td> </tr> <tr> <td>設計94</td> <td>○</td> <td>○</td> <td>○</td> <td>○</td> <td>○</td> <td>○</td> <td>○</td> <td></td> <td></td> </tr> <tr> <td>設計95</td> <td>○</td> <td>○</td> <td>○</td> <td>○</td> <td>○</td> <td>○</td> <td>○</td> <td></td> <td></td> </tr> <tr> <td>設計96</td> <td>○</td> <td>○</td> <td>○</td> <td>○</td> <td>○</td> <td>○</td> <td>○</td> <td></td> <td></td> </tr> <tr> <td>設計97</td> <td>○</td> <td>○</td> <td>○</td> <td>○</td> <td>○</td> <td>○</td> <td>○</td> <td></td> <td></td> </tr> <tr> <td>設計98</td> <td>○</td> <td>○</td> <td>○</td> <td>○</td> <td>○</td> <td>○</td> <td>○</td> <td></td> <td></td> </tr> <tr> <td>設計99</td> <td>○</td> <td>○</td> <td>○</td> <td>○</td> <td>○</td> <td>○</td> <td>○</td> <td></td> <td></td> </tr> <tr> <td>設計100</td> <td>○</td> <td>○</td> <td>○</td> <td>○</td> <td>○</td> <td>○</td> <td>○</td> <td></td> <td></td> </tr> </tbody> </table> </div>	標準仕様		大飯原子力発電所 (設計仕様)		女川原子力発電所 (設計仕様)		泊発電所3号炉 (設計仕様)		相違理由		項目	標準仕様	大飯	女川	泊	大飯	女川	泊	相違	理由	設計1	○	○	○	○	○	○	○			設計2	○	○	○	○	○	○	○			設計3	○	○	○	○	○	○	○			設計4	○	○	○	○	○	○	○			設計5	○	○	○	○	○	○	○			設計6	○	○	○	○	○	○	○			設計7	○	○	○	○	○	○	○			設計8	○	○	○	○	○	○	○			設計9	○	○	○	○	○	○	○			設計10	○	○	○	○	○	○	○			設計11	○	○	○	○	○	○	○			設計12	○	○	○	○	○	○	○			設計13	○	○	○	○	○	○	○			設計14	○	○	○	○	○	○	○			設計15	○	○	○	○	○	○	○			設計16	○	○	○	○	○	○	○			設計17	○	○	○	○	○	○	○			設計18	○	○	○	○	○	○	○			設計19	○	○	○	○	○	○	○			設計20	○	○	○	○	○	○	○			設計21	○	○	○	○	○	○	○			設計22	○	○	○	○	○	○	○			設計23	○	○	○	○	○	○	○			設計24	○	○	○	○	○	○	○			設計25	○	○	○	○	○	○	○			設計26	○	○	○	○	○	○	○			設計27	○	○	○	○	○	○	○			設計28	○	○	○	○	○	○	○			設計29	○	○	○	○	○	○	○			設計30	○	○	○	○	○	○	○			設計31	○	○	○	○	○	○	○			設計32	○	○	○	○	○	○	○			設計33	○	○	○	○	○	○	○			設計34	○	○	○	○	○	○	○			設計35	○	○	○	○	○	○	○			設計36	○	○	○	○	○	○	○			設計37	○	○	○	○	○	○	○			設計38	○	○	○	○	○	○	○			設計39	○	○	○	○	○	○	○			設計40	○	○	○	○	○	○	○			設計41	○	○	○	○	○	○	○			設計42	○	○	○	○	○	○	○			設計43	○	○	○	○	○	○	○			設計44	○	○	○	○	○	○	○			設計45	○	○	○	○	○	○	○			設計46	○	○	○	○	○	○	○			設計47	○	○	○	○	○	○	○			設計48	○	○	○	○	○	○	○			設計49	○	○	○	○	○	○	○			設計50	○	○	○	○	○	○	○			設計51	○	○	○	○	○	○	○			設計52	○	○	○	○	○	○	○			設計53	○	○	○	○	○	○	○			設計54	○	○	○	○	○	○	○			設計55	○	○	○	○	○	○	○			設計56	○	○	○	○	○	○	○			設計57	○	○	○	○	○	○	○			設計58	○	○	○	○	○	○	○			設計59	○	○	○	○	○	○	○			設計60	○	○	○	○	○	○	○			設計61	○	○	○	○	○	○	○			設計62	○	○	○	○	○	○	○			設計63	○	○	○	○	○	○	○			設計64	○	○	○	○	○	○	○			設計65	○	○	○	○	○	○	○			設計66	○	○	○	○	○	○	○			設計67	○	○	○	○	○	○	○			設計68	○	○	○	○	○	○	○			設計69	○	○	○	○	○	○	○			設計70	○	○	○	○	○	○	○			設計71	○	○	○	○	○	○	○			設計72	○	○	○	○	○	○	○			設計73	○	○	○	○	○	○	○			設計74	○	○	○	○	○	○	○			設計75	○	○	○	○	○	○	○			設計76	○	○	○	○	○	○	○			設計77	○	○	○	○	○	○	○			設計78	○	○	○	○	○	○	○			設計79	○	○	○	○	○	○	○			設計80	○	○	○	○	○	○	○			設計81	○	○	○	○	○	○	○			設計82	○	○	○	○	○	○	○			設計83	○	○	○	○	○	○	○			設計84	○	○	○	○	○	○	○			設計85	○	○	○	○	○	○	○			設計86	○	○	○	○	○	○	○			設計87	○	○	○	○	○	○	○			設計88	○	○	○	○	○	○	○			設計89	○	○	○	○	○	○	○			設計90	○	○	○	○	○	○	○			設計91	○	○	○	○	○	○	○			設計92	○	○	○	○	○	○	○			設計93	○	○	○	○	○	○	○			設計94	○	○	○	○	○	○	○			設計95	○	○	○	○	○	○	○			設計96	○	○	○	○	○	○	○			設計97	○	○	○	○	○	○	○			設計98	○	○	○	○	○	○	○			設計99	○	○	○	○	○	○	○			設計100	○	○	○	○	○	○	○				<p>【女川】 設計方針の相違 プラント設計の違いによる評価結果の相違</p>
標準仕様		大飯原子力発電所 (設計仕様)		女川原子力発電所 (設計仕様)		泊発電所3号炉 (設計仕様)		相違理由																																																																																																																																																																																																																																																																																																																																																																																																																																																																																																																																																																																																																																																																																																																																																																																																																																																																																																																																																																																																																																																							
項目	標準仕様	大飯	女川	泊	大飯	女川	泊	相違	理由																																																																																																																																																																																																																																																																																																																																																																																																																																																																																																																																																																																																																																																																																																																																																																																																																																																																																																																																																																																																																																																						
設計1	○	○	○	○	○	○	○																																																																																																																																																																																																																																																																																																																																																																																																																																																																																																																																																																																																																																																																																																																																																																																																																																																																																																																																																																																																																																																								
設計2	○	○	○	○	○	○	○																																																																																																																																																																																																																																																																																																																																																																																																																																																																																																																																																																																																																																																																																																																																																																																																																																																																																																																																																																																																																																																								
設計3	○	○	○	○	○	○	○																																																																																																																																																																																																																																																																																																																																																																																																																																																																																																																																																																																																																																																																																																																																																																																																																																																																																																																																																																																																																																																								
設計4	○	○	○	○	○	○	○																																																																																																																																																																																																																																																																																																																																																																																																																																																																																																																																																																																																																																																																																																																																																																																																																																																																																																																																																																																																																																																								
設計5	○	○	○	○	○	○	○																																																																																																																																																																																																																																																																																																																																																																																																																																																																																																																																																																																																																																																																																																																																																																																																																																																																																																																																																																																																																																																								
設計6	○	○	○	○	○	○	○																																																																																																																																																																																																																																																																																																																																																																																																																																																																																																																																																																																																																																																																																																																																																																																																																																																																																																																																																																																																																																																								
設計7	○	○	○	○	○	○	○																																																																																																																																																																																																																																																																																																																																																																																																																																																																																																																																																																																																																																																																																																																																																																																																																																																																																																																																																																																																																																																								
設計8	○	○	○	○	○	○	○																																																																																																																																																																																																																																																																																																																																																																																																																																																																																																																																																																																																																																																																																																																																																																																																																																																																																																																																																																																																																																																								
設計9	○	○	○	○	○	○	○																																																																																																																																																																																																																																																																																																																																																																																																																																																																																																																																																																																																																																																																																																																																																																																																																																																																																																																																																																																																																																																								
設計10	○	○	○	○	○	○	○																																																																																																																																																																																																																																																																																																																																																																																																																																																																																																																																																																																																																																																																																																																																																																																																																																																																																																																																																																																																																																																								
設計11	○	○	○	○	○	○	○																																																																																																																																																																																																																																																																																																																																																																																																																																																																																																																																																																																																																																																																																																																																																																																																																																																																																																																																																																																																																																																								
設計12	○	○	○	○	○	○	○																																																																																																																																																																																																																																																																																																																																																																																																																																																																																																																																																																																																																																																																																																																																																																																																																																																																																																																																																																																																																																																								
設計13	○	○	○	○	○	○	○																																																																																																																																																																																																																																																																																																																																																																																																																																																																																																																																																																																																																																																																																																																																																																																																																																																																																																																																																																																																																																																								
設計14	○	○	○	○	○	○	○																																																																																																																																																																																																																																																																																																																																																																																																																																																																																																																																																																																																																																																																																																																																																																																																																																																																																																																																																																																																																																																								
設計15	○	○	○	○	○	○	○																																																																																																																																																																																																																																																																																																																																																																																																																																																																																																																																																																																																																																																																																																																																																																																																																																																																																																																																																																																																																																																								
設計16	○	○	○	○	○	○	○																																																																																																																																																																																																																																																																																																																																																																																																																																																																																																																																																																																																																																																																																																																																																																																																																																																																																																																																																																																																																																																								
設計17	○	○	○	○	○	○	○																																																																																																																																																																																																																																																																																																																																																																																																																																																																																																																																																																																																																																																																																																																																																																																																																																																																																																																																																																																																																																																								
設計18	○	○	○	○	○	○	○																																																																																																																																																																																																																																																																																																																																																																																																																																																																																																																																																																																																																																																																																																																																																																																																																																																																																																																																																																																																																																																								
設計19	○	○	○	○	○	○	○																																																																																																																																																																																																																																																																																																																																																																																																																																																																																																																																																																																																																																																																																																																																																																																																																																																																																																																																																																																																																																																								
設計20	○	○	○	○	○	○	○																																																																																																																																																																																																																																																																																																																																																																																																																																																																																																																																																																																																																																																																																																																																																																																																																																																																																																																																																																																																																																																								
設計21	○	○	○	○	○	○	○																																																																																																																																																																																																																																																																																																																																																																																																																																																																																																																																																																																																																																																																																																																																																																																																																																																																																																																																																																																																																																																								
設計22	○	○	○	○	○	○	○																																																																																																																																																																																																																																																																																																																																																																																																																																																																																																																																																																																																																																																																																																																																																																																																																																																																																																																																																																																																																																																								
設計23	○	○	○	○	○	○	○																																																																																																																																																																																																																																																																																																																																																																																																																																																																																																																																																																																																																																																																																																																																																																																																																																																																																																																																																																																																																																																								
設計24	○	○	○	○	○	○	○																																																																																																																																																																																																																																																																																																																																																																																																																																																																																																																																																																																																																																																																																																																																																																																																																																																																																																																																																																																																																																																								
設計25	○	○	○	○	○	○	○																																																																																																																																																																																																																																																																																																																																																																																																																																																																																																																																																																																																																																																																																																																																																																																																																																																																																																																																																																																																																																																								
設計26	○	○	○	○	○	○	○																																																																																																																																																																																																																																																																																																																																																																																																																																																																																																																																																																																																																																																																																																																																																																																																																																																																																																																																																																																																																																																								
設計27	○	○	○	○	○	○	○																																																																																																																																																																																																																																																																																																																																																																																																																																																																																																																																																																																																																																																																																																																																																																																																																																																																																																																																																																																																																																																								
設計28	○	○	○	○	○	○	○																																																																																																																																																																																																																																																																																																																																																																																																																																																																																																																																																																																																																																																																																																																																																																																																																																																																																																																																																																																																																																																								
設計29	○	○	○	○	○	○	○																																																																																																																																																																																																																																																																																																																																																																																																																																																																																																																																																																																																																																																																																																																																																																																																																																																																																																																																																																																																																																																								
設計30	○	○	○	○	○	○	○																																																																																																																																																																																																																																																																																																																																																																																																																																																																																																																																																																																																																																																																																																																																																																																																																																																																																																																																																																																																																																																								
設計31	○	○	○	○	○	○	○																																																																																																																																																																																																																																																																																																																																																																																																																																																																																																																																																																																																																																																																																																																																																																																																																																																																																																																																																																																																																																																								
設計32	○	○	○	○	○	○	○																																																																																																																																																																																																																																																																																																																																																																																																																																																																																																																																																																																																																																																																																																																																																																																																																																																																																																																																																																																																																																																								
設計33	○	○	○	○	○	○	○																																																																																																																																																																																																																																																																																																																																																																																																																																																																																																																																																																																																																																																																																																																																																																																																																																																																																																																																																																																																																																																								
設計34	○	○	○	○	○	○	○																																																																																																																																																																																																																																																																																																																																																																																																																																																																																																																																																																																																																																																																																																																																																																																																																																																																																																																																																																																																																																																								
設計35	○	○	○	○	○	○	○																																																																																																																																																																																																																																																																																																																																																																																																																																																																																																																																																																																																																																																																																																																																																																																																																																																																																																																																																																																																																																																								
設計36	○	○	○	○	○	○	○																																																																																																																																																																																																																																																																																																																																																																																																																																																																																																																																																																																																																																																																																																																																																																																																																																																																																																																																																																																																																																																								
設計37	○	○	○	○	○	○	○																																																																																																																																																																																																																																																																																																																																																																																																																																																																																																																																																																																																																																																																																																																																																																																																																																																																																																																																																																																																																																																								
設計38	○	○	○	○	○	○	○																																																																																																																																																																																																																																																																																																																																																																																																																																																																																																																																																																																																																																																																																																																																																																																																																																																																																																																																																																																																																																																								
設計39	○	○	○	○	○	○	○																																																																																																																																																																																																																																																																																																																																																																																																																																																																																																																																																																																																																																																																																																																																																																																																																																																																																																																																																																																																																																																								
設計40	○	○	○	○	○	○	○																																																																																																																																																																																																																																																																																																																																																																																																																																																																																																																																																																																																																																																																																																																																																																																																																																																																																																																																																																																																																																																								
設計41	○	○	○	○	○	○	○																																																																																																																																																																																																																																																																																																																																																																																																																																																																																																																																																																																																																																																																																																																																																																																																																																																																																																																																																																																																																																																								
設計42	○	○	○	○	○	○	○																																																																																																																																																																																																																																																																																																																																																																																																																																																																																																																																																																																																																																																																																																																																																																																																																																																																																																																																																																																																																																																								
設計43	○	○	○	○	○	○	○																																																																																																																																																																																																																																																																																																																																																																																																																																																																																																																																																																																																																																																																																																																																																																																																																																																																																																																																																																																																																																																								
設計44	○	○	○	○	○	○	○																																																																																																																																																																																																																																																																																																																																																																																																																																																																																																																																																																																																																																																																																																																																																																																																																																																																																																																																																																																																																																																								
設計45	○	○	○	○	○	○	○																																																																																																																																																																																																																																																																																																																																																																																																																																																																																																																																																																																																																																																																																																																																																																																																																																																																																																																																																																																																																																																								
設計46	○	○	○	○	○	○	○																																																																																																																																																																																																																																																																																																																																																																																																																																																																																																																																																																																																																																																																																																																																																																																																																																																																																																																																																																																																																																																								
設計47	○	○	○	○	○	○	○																																																																																																																																																																																																																																																																																																																																																																																																																																																																																																																																																																																																																																																																																																																																																																																																																																																																																																																																																																																																																																																								
設計48	○	○	○	○	○	○	○																																																																																																																																																																																																																																																																																																																																																																																																																																																																																																																																																																																																																																																																																																																																																																																																																																																																																																																																																																																																																																																								
設計49	○	○	○	○	○	○	○																																																																																																																																																																																																																																																																																																																																																																																																																																																																																																																																																																																																																																																																																																																																																																																																																																																																																																																																																																																																																																																								
設計50	○	○	○	○	○	○	○																																																																																																																																																																																																																																																																																																																																																																																																																																																																																																																																																																																																																																																																																																																																																																																																																																																																																																																																																																																																																																																								
設計51	○	○	○	○	○	○	○																																																																																																																																																																																																																																																																																																																																																																																																																																																																																																																																																																																																																																																																																																																																																																																																																																																																																																																																																																																																																																																								
設計52	○	○	○	○	○	○	○																																																																																																																																																																																																																																																																																																																																																																																																																																																																																																																																																																																																																																																																																																																																																																																																																																																																																																																																																																																																																																																								
設計53	○	○	○	○	○	○	○																																																																																																																																																																																																																																																																																																																																																																																																																																																																																																																																																																																																																																																																																																																																																																																																																																																																																																																																																																																																																																																								
設計54	○	○	○	○	○	○	○																																																																																																																																																																																																																																																																																																																																																																																																																																																																																																																																																																																																																																																																																																																																																																																																																																																																																																																																																																																																																																																								
設計55	○	○	○	○	○	○	○																																																																																																																																																																																																																																																																																																																																																																																																																																																																																																																																																																																																																																																																																																																																																																																																																																																																																																																																																																																																																																																								
設計56	○	○	○	○	○	○	○																																																																																																																																																																																																																																																																																																																																																																																																																																																																																																																																																																																																																																																																																																																																																																																																																																																																																																																																																																																																																																																								
設計57	○	○	○	○	○	○	○																																																																																																																																																																																																																																																																																																																																																																																																																																																																																																																																																																																																																																																																																																																																																																																																																																																																																																																																																																																																																																																								
設計58	○	○	○	○	○	○	○																																																																																																																																																																																																																																																																																																																																																																																																																																																																																																																																																																																																																																																																																																																																																																																																																																																																																																																																																																																																																																																								
設計59	○	○	○	○	○	○	○																																																																																																																																																																																																																																																																																																																																																																																																																																																																																																																																																																																																																																																																																																																																																																																																																																																																																																																																																																																																																																																								
設計60	○	○	○	○	○	○	○																																																																																																																																																																																																																																																																																																																																																																																																																																																																																																																																																																																																																																																																																																																																																																																																																																																																																																																																																																																																																																																								
設計61	○	○	○	○	○	○	○																																																																																																																																																																																																																																																																																																																																																																																																																																																																																																																																																																																																																																																																																																																																																																																																																																																																																																																																																																																																																																																								
設計62	○	○	○	○	○	○	○																																																																																																																																																																																																																																																																																																																																																																																																																																																																																																																																																																																																																																																																																																																																																																																																																																																																																																																																																																																																																																																								
設計63	○	○	○	○	○	○	○																																																																																																																																																																																																																																																																																																																																																																																																																																																																																																																																																																																																																																																																																																																																																																																																																																																																																																																																																																																																																																																								
設計64	○	○	○	○	○	○	○																																																																																																																																																																																																																																																																																																																																																																																																																																																																																																																																																																																																																																																																																																																																																																																																																																																																																																																																																																																																																																																								
設計65	○	○	○	○	○	○	○																																																																																																																																																																																																																																																																																																																																																																																																																																																																																																																																																																																																																																																																																																																																																																																																																																																																																																																																																																																																																																																								
設計66	○	○	○	○	○	○	○																																																																																																																																																																																																																																																																																																																																																																																																																																																																																																																																																																																																																																																																																																																																																																																																																																																																																																																																																																																																																																																								
設計67	○	○	○	○	○	○	○																																																																																																																																																																																																																																																																																																																																																																																																																																																																																																																																																																																																																																																																																																																																																																																																																																																																																																																																																																																																																																																								
設計68	○	○	○	○	○	○	○																																																																																																																																																																																																																																																																																																																																																																																																																																																																																																																																																																																																																																																																																																																																																																																																																																																																																																																																																																																																																																																								
設計69	○	○	○	○	○	○	○																																																																																																																																																																																																																																																																																																																																																																																																																																																																																																																																																																																																																																																																																																																																																																																																																																																																																																																																																																																																																																																								
設計70	○	○	○	○	○	○	○																																																																																																																																																																																																																																																																																																																																																																																																																																																																																																																																																																																																																																																																																																																																																																																																																																																																																																																																																																																																																																																								
設計71	○	○	○	○	○	○	○																																																																																																																																																																																																																																																																																																																																																																																																																																																																																																																																																																																																																																																																																																																																																																																																																																																																																																																																																																																																																																																								
設計72	○	○	○	○	○	○	○																																																																																																																																																																																																																																																																																																																																																																																																																																																																																																																																																																																																																																																																																																																																																																																																																																																																																																																																																																																																																																																								
設計73	○	○	○	○	○	○	○																																																																																																																																																																																																																																																																																																																																																																																																																																																																																																																																																																																																																																																																																																																																																																																																																																																																																																																																																																																																																																																								
設計74	○	○	○	○	○	○	○																																																																																																																																																																																																																																																																																																																																																																																																																																																																																																																																																																																																																																																																																																																																																																																																																																																																																																																																																																																																																																																								
設計75	○	○	○	○	○	○	○																																																																																																																																																																																																																																																																																																																																																																																																																																																																																																																																																																																																																																																																																																																																																																																																																																																																																																																																																																																																																																																								
設計76	○	○	○	○	○	○	○																																																																																																																																																																																																																																																																																																																																																																																																																																																																																																																																																																																																																																																																																																																																																																																																																																																																																																																																																																																																																																																								
設計77	○	○	○	○	○	○	○																																																																																																																																																																																																																																																																																																																																																																																																																																																																																																																																																																																																																																																																																																																																																																																																																																																																																																																																																																																																																																																								
設計78	○	○	○	○	○	○	○																																																																																																																																																																																																																																																																																																																																																																																																																																																																																																																																																																																																																																																																																																																																																																																																																																																																																																																																																																																																																																																								
設計79	○	○	○	○	○	○	○																																																																																																																																																																																																																																																																																																																																																																																																																																																																																																																																																																																																																																																																																																																																																																																																																																																																																																																																																																																																																																																								
設計80	○	○	○	○	○	○	○																																																																																																																																																																																																																																																																																																																																																																																																																																																																																																																																																																																																																																																																																																																																																																																																																																																																																																																																																																																																																																																								
設計81	○	○	○	○	○	○	○																																																																																																																																																																																																																																																																																																																																																																																																																																																																																																																																																																																																																																																																																																																																																																																																																																																																																																																																																																																																																																																								
設計82	○	○	○	○	○	○	○																																																																																																																																																																																																																																																																																																																																																																																																																																																																																																																																																																																																																																																																																																																																																																																																																																																																																																																																																																																																																																																								
設計83	○	○	○	○	○	○	○																																																																																																																																																																																																																																																																																																																																																																																																																																																																																																																																																																																																																																																																																																																																																																																																																																																																																																																																																																																																																																																								
設計84	○	○	○	○	○	○	○																																																																																																																																																																																																																																																																																																																																																																																																																																																																																																																																																																																																																																																																																																																																																																																																																																																																																																																																																																																																																																																								
設計85	○	○	○	○	○	○	○																																																																																																																																																																																																																																																																																																																																																																																																																																																																																																																																																																																																																																																																																																																																																																																																																																																																																																																																																																																																																																																								
設計86	○	○	○	○	○	○	○																																																																																																																																																																																																																																																																																																																																																																																																																																																																																																																																																																																																																																																																																																																																																																																																																																																																																																																																																																																																																																																								
設計87	○	○	○	○	○	○	○																																																																																																																																																																																																																																																																																																																																																																																																																																																																																																																																																																																																																																																																																																																																																																																																																																																																																																																																																																																																																																																								
設計88	○	○	○	○	○	○	○																																																																																																																																																																																																																																																																																																																																																																																																																																																																																																																																																																																																																																																																																																																																																																																																																																																																																																																																																																																																																																																								
設計89	○	○	○	○	○	○	○																																																																																																																																																																																																																																																																																																																																																																																																																																																																																																																																																																																																																																																																																																																																																																																																																																																																																																																																																																																																																																																								
設計90	○	○	○	○	○	○	○																																																																																																																																																																																																																																																																																																																																																																																																																																																																																																																																																																																																																																																																																																																																																																																																																																																																																																																																																																																																																																																								
設計91	○	○	○	○	○	○	○																																																																																																																																																																																																																																																																																																																																																																																																																																																																																																																																																																																																																																																																																																																																																																																																																																																																																																																																																																																																																																																								
設計92	○	○	○	○	○	○	○																																																																																																																																																																																																																																																																																																																																																																																																																																																																																																																																																																																																																																																																																																																																																																																																																																																																																																																																																																																																																																																								
設計93	○	○	○	○	○	○	○																																																																																																																																																																																																																																																																																																																																																																																																																																																																																																																																																																																																																																																																																																																																																																																																																																																																																																																																																																																																																																																								
設計94	○	○	○	○	○	○	○																																																																																																																																																																																																																																																																																																																																																																																																																																																																																																																																																																																																																																																																																																																																																																																																																																																																																																																																																																																																																																																								
設計95	○	○	○	○	○	○	○																																																																																																																																																																																																																																																																																																																																																																																																																																																																																																																																																																																																																																																																																																																																																																																																																																																																																																																																																																																																																																																								
設計96	○	○	○	○	○	○	○																																																																																																																																																																																																																																																																																																																																																																																																																																																																																																																																																																																																																																																																																																																																																																																																																																																																																																																																																																																																																																																								
設計97	○	○	○	○	○	○	○																																																																																																																																																																																																																																																																																																																																																																																																																																																																																																																																																																																																																																																																																																																																																																																																																																																																																																																																																																																																																																																								
設計98	○	○	○	○	○	○	○																																																																																																																																																																																																																																																																																																																																																																																																																																																																																																																																																																																																																																																																																																																																																																																																																																																																																																																																																																																																																																																								
設計99	○	○	○	○	○	○	○																																																																																																																																																																																																																																																																																																																																																																																																																																																																																																																																																																																																																																																																																																																																																																																																																																																																																																																																																																																																																																																								
設計100	○	○	○	○	○	○	○																																																																																																																																																																																																																																																																																																																																																																																																																																																																																																																																																																																																																																																																																																																																																																																																																																																																																																																																																																																																																																																								

赤字：設備、運用又は体制の相違（設計方針の相違）
 青字：記載箇所又は記載内容の相違（記載方針の相違）
 緑字：記載表現、設備名称の相違（実質的な相違なし）

大飯発電所3/4号炉	女川原子力発電所2号炉	泊発電所3号炉	相違理由																																				
	<p>表1 浸水影響評価結果整理表(想定破損)(6/7)</p> <table border="1"> <thead> <tr> <th>評価項目</th> <th>評価内容</th> <th>評価結果</th> </tr> </thead> <tbody> <tr> <td>1. 浸水による設備の損傷</td> <td>...</td> <td>...</td> </tr> <tr> <td>2. 浸水による設備の故障</td> <td>...</td> <td>...</td> </tr> <tr> <td>3. 浸水による設備の劣化</td> <td>...</td> <td>...</td> </tr> <tr> <td>4. 浸水による設備の破損</td> <td>...</td> <td>...</td> </tr> <tr> <td>5. 浸水による設備の消失</td> <td>...</td> <td>...</td> </tr> </tbody> </table> <p>注：浸水による設備の損傷、故障、劣化、破損、消失は、想定破損によるものである。</p>	評価項目	評価内容	評価結果	1. 浸水による設備の損傷	2. 浸水による設備の故障	3. 浸水による設備の劣化	4. 浸水による設備の破損	5. 浸水による設備の消失	<p>表1 浸水影響評価結果整理表(想定破損)(6/7)</p> <table border="1"> <thead> <tr> <th>評価項目</th> <th>評価内容</th> <th>評価結果</th> </tr> </thead> <tbody> <tr> <td>1. 浸水による設備の損傷</td> <td>...</td> <td>...</td> </tr> <tr> <td>2. 浸水による設備の故障</td> <td>...</td> <td>...</td> </tr> <tr> <td>3. 浸水による設備の劣化</td> <td>...</td> <td>...</td> </tr> <tr> <td>4. 浸水による設備の破損</td> <td>...</td> <td>...</td> </tr> <tr> <td>5. 浸水による設備の消失</td> <td>...</td> <td>...</td> </tr> </tbody> </table> <p>注：浸水による設備の損傷、故障、劣化、破損、消失は、想定破損によるものである。</p>	評価項目	評価内容	評価結果	1. 浸水による設備の損傷	2. 浸水による設備の故障	3. 浸水による設備の劣化	4. 浸水による設備の破損	5. 浸水による設備の消失	<p>【女川】 設計方針の相違 プラント設計の違いによる評価結果の相違</p> <p>【参考】【伊方】 記載方針の相違 泊と同様のまとめ方をしている先行PWRとしては、伊方、川内、玄海があり、大飯の評価結果の後(9-別添1-添17-25)に伊方の評価結果を掲載する。</p>
評価項目	評価内容	評価結果																																					
1. 浸水による設備の損傷																																					
2. 浸水による設備の故障																																					
3. 浸水による設備の劣化																																					
4. 浸水による設備の破損																																					
5. 浸水による設備の消失																																					
評価項目	評価内容	評価結果																																					
1. 浸水による設備の損傷																																					
2. 浸水による設備の故障																																					
3. 浸水による設備の劣化																																					
4. 浸水による設備の破損																																					
5. 浸水による設備の消失																																					

枠囲みの内容は機密情報に属しますので公開できません。

